

# Crawler Crane / Grue sur chenilles mobile

## LR 1500

# BUCKNER

HEAVYLIFT CRANES

smart crane  
**LIEBHERR**  
**strong compact**



550 USt



433 ft



276 ft + 276 ft



374,800 lbs



88,200 lbs



617,300 lbs  
x 52.5 ft



25 ft



# LIEBHERR

# Table of content

## Tables des matières

---

Technical Data/Caractéristiques technique	
Equipment/Equipement	3 – 4
Dimensions/Encombrement	5 – 9
Crane data/Dates de la grue	10
Transportation plan/Plan de transport	11 – 12
Boom/jib combinations/Configurations de flèche	13 – 15
SL	16 – 17
SL2DB	18 – 20
S	21 – 22
SDB	23 – 25
SW	26 – 40
SDWB	41 – 59
Example/Exemple $W_{max}$	60
SLF	61 – 69
SL3F	70 – 78
SL4DFB	79 – 81
SL8F	82 – 84
Description of symbols/Explication des symboles	85
Remarks/Remarques	86

---

# Equipment Equipment

<b>Max. capacity</b>	882,000 lbs at 39 ft radius, SDB-system with S 118 ft. 1,102,000 lbs at 25 ft radius, S2DB-system with S2 113 ft.
<b>Max. load moment</b>	43,486,600 lbs-ft, 650,000 lbs at 66 ft radius, SDB-system with S 118 ft.

## Crawler travel gear

<b>Crawler chassis</b>	Liebherr crawler chassis consisting of one centre section and two crawler carriers with crawler plates 5 ft and quadruple drive (double drive optional).
<b>Central ballast</b>	Total central ballast 88,200 lbs. 2 x 11,025 lbs walk, 2 x 33,075 lbs (optional).

## Crane superstructure

<b>Superstructure frame</b>	Liebherr-slewing platform frame, consisting of slewing platform with winch IV and removable A-frame, connected to the centre section by a roller slewing bearing.
<b>Engine</b>	6-cylinder Diesel, make Liebherr, watercooled, output 350 kW (476 h.p.), max. torque 1,836 lbs-ft. Exhaust emissions acc. to 97/68/EG, EPA/CARB, ECE-R.96. Fuel reservoir: 322 gallons.
<b>Winch I</b>	Standard hoist winch, hydraulically driven by variable axial piston motors with integrated planetary gears.
<b>Winch IV</b>	Boom hoist.
<b>Reeving winch</b>	Auxiliary winch for the reeving of ropes.
<b>Slewing gear</b>	2 slewing gears, hydraulically driven by variable axial piston motors with integrated planetary gears.
<b>Crane cabin</b>	Air conditioned crane cabin tiltable to the rear with safety glazing, heat insulating glass, roof window with bullet proof glass, standardized control units ergonomically positioned. Additional thermostatically controlled hot water heating.
<b>Crane control</b>	Setting of configuration data by convenient interactive functions. All crane movements are initiated by means of two 4-way joystick hand levers and two 2-way hand/foot levers. All working movements are independently controllable.
<b>Safety devices</b>	Hoist limit switch. Safety valves against hose and pipe rupture. Drum switch limit at 3 rest layers. Wind speed gauge. Electronic inclination indicator. Aircraft warning control light.
<b>Camera observation</b>	2 colour-screens, 3 cameras for winches and rear area.
<b>Counterweight</b>	2 brackets 11,025 lbs each. Total counterweight at superstructure 374,800 lbs. 16 ballast plates 22,050 lbs each (option).

## Boom system

<b>Main boom S</b>	System 2822 with head section for max. load capacity of 882,000 lbs. Boom length S 79 ft – S 315 ft, boom length SDB 118 ft – SDB 374 ft with derrick system.
<b>Lattice type luffing fly jib W</b>	System 2418 with head section for max. 551,200 lbs load capacity. Luffing jib lengths 59 ft – 276 ft. Winch V is needed for all luffing jib operations.
<b>Fixed lattice fly jib F</b>	System 1812 with head section for max. capacity of 271,200 lbs, attachable at 10°, 15° and 30°, jib lengths F 39 ft – F 118 ft.
<b>Derrick system D</b>	System 2420 including guy rods. Winch III is needed for all derrick operations. Length 98 ft.
<b>Counterweight frame B</b>	For max. derrick counterweight of 617,300 lbs, for infinitely variable radius from 30 ft – 53 ft.
<b>Counterweight trailer BW</b>	For max. derrick counterweight of 617,300 lbs at max. radius of 53 ft, infinitely variable radii from 39 ft – 53 ft.
<b>Derrick-Counterweight</b>	Plates for a total of 617,300 lbs.
<b>Heavy duty jib WV</b>	Using existing parts of main boom and luffing jib. Length 59 ft – 276 ft.
<b>Winch II</b>	Second hoist winch.
<b>Winch III</b>	Reeving main boom / Derrick operation.
<b>Winch V</b>	Luffing for W-jib configuration.
<b>Whip line 55100 lbs</b>	To be mounted on the S and L-boom head.

## Additional equipment

<b>Mechanical outriggers</b>	For erection of long boom combinations without derrick-counterweight.
<b>Hydraulic assembly jacks</b>	Lifting of the basic machine for assembly/disassembly. Consisting of 4 lifting cylinders with supporting plates, installed on the centre part.
<b>Hydraulic assembly cylinder</b>	For assembly/disassembly of the crawler carrier by the crane itself.
<b>Pin pulling device</b>	Including mobile hydraulic power pack. For pinning of the basic unit and the S- and L- intermediate sections.

**Other items of equipment available on request.**  
**Standard equipment and options according to effective price list.**

# Equipment Équipement

<b>Capacité max.</b>	882,000 lbs pour une portée de 39 ft. Système SDB avec S 118 ft. 1,102,000 lbs pour une portée de 25 ft. Système S2DB avec S2 113 ft.
<b>Couple de charge max.</b>	43,486,600 lbs-ft – 650,000 lbs pour une portée de 66 ft. Système SDB avec S 118 ft.

## Train de chenilles

<b>Mécanisme de translation</b>	Le train de chenilles Liebherr est composé d'une partie centrale et de deux longerons avec patins de chenilles 5 ft et un entraînement à 4 positions (2 positions en option).
<b>Contrepoids central</b>	Contrepoids central total 88,200 lbs. 2 x 11,025 lbs passerelle, 2 x 33,075 lbs (en option).

## Partie tournante

<b>Cadre de la partie tournante</b>	Le cadre de la partie tournante Liebherr est composé de la partie tournante avec treuil IV et du chevalet démontable A, il est relié à la partie centrale du train de roulement par une couronne d'orientation à rouleaux.
<b>Moteur</b>	Moteur diesel, 6 cylindres, fabriqué par Liebherr, à refroidissement par eau, de 350 kW (476 ch), couple max. 1,836 lbs-ft. Émissions des gaz d'échappement conformes aux directives 97/68/EG, EPA/CARB, ECE-R.96. Capacité du réservoir à carburant: 322 gallons.
<b>Treuil I</b>	Treuil de levage standard, commande hydraulique avec moteurs à cylindrée variable et pistons axiaux, réducteur planétaire intégré.
<b>Treuil IV</b>	Mécanisme de relevage.
<b>Treuil de mouflage</b>	Treuil auxiliaire pour le mouflage des câbles.
<b>Mécanisme d'orientation</b>	2 mécanismes d'orientation, commande hydraulique avec moteurs à cylindrée variable et pistons axiaux, réducteur planétaire intégré.
<b>Cabine du grutier</b>	La cabine du grutier est climatisée, inclinable vers l'arrière, possède un vitrage de sécurité, un vitrage isolant thermiquement, une fenêtre de toit en verre blindé, des unités de commande normalisées disposées de façon ergonomique. Chauffage d'appoint et chauffage de l'eau régulé thermostatiquement.
<b>Commande de la grue</b>	Entrée des données de configuration par des fonctions interactives simples. Tous les mouvements de la grue sont commandés par deux manipulateurs à 4 voies et deux pédale/levier à 2 voies. Tous les mouvements de travail peuvent être commandés indépendamment.
<b>Dispositifs de sécurité</b>	Interrupteur de fin de course. Clapets de sécurité contre les ruptures de tuyaux et de flexibles. Coupure de fin de course du tambour avec 3 enrroulements de sécurité. Anémomètre de sécurité. Inclinomètre électronique. Balise aérienne.
<b>Contrôle vidéo</b>	2 écrans couleur, 3 caméras pour la zone de treuils et la partie arrière.
<b>Contrepoids</b>	2 consoles de 11,025 lbs chacune. Contrepoids total 374,800 lbs. 16 plaques de lest à 22,050 lbs (option).

## Système de flèche

<b>Flèche principale S</b>	Système 2822 avec élément de tête pour une capacité de charge max. de 882,000 lbs. Longueur de flèche S 79 ft – S 315 ft. Longueur de flèche SDB 118 ft – SDB 374 ft avec système derrick.
<b>Fléchette treillis à volée variable W</b>	Système 2418 avec élément de tête pour une capacité max. de 551,200 lbs. Longueurs de flèche treillis 59 ft – 276 ft. Le treuil V est nécessaire pour fonctionnement fléchette treillis.
<b>Fléchette treillis fixe F</b>	Système 1812 avec élément de tête pour une capacité max. de 271,200 lbs, montage possible sous 10°, 15° et 30°. Longueurs de flèche F 39 ft – F 118 ft.
<b>Système derrick D</b>	Le système 2420 comprend des tirants. Le treuil III est nécessaire au mode derrick. Longueur 98 ft.
<b>Palette de lest B</b>	Pour un contrepoids derrick max. de 617,300 lbs et rayons variables progressivement de 30 ft – 53 ft.
<b>Remorque à contrepoids BW</b>	Pour un contrepoids derrick max. de 617,300 lbs pour un rayon max. de 53 ft, pour des rayons variables progressivement de 39 ft – 53 ft.
<b>Contrepoids derrick</b>	Plaques de poids total de 617,300 lbs.
<b>Fléchette pour charge lourde WV</b>	Utilisation des parties disponibles de la flèche principale et de la fléchette treillis. Longueur 59 ft – 276 ft.
<b>Treuil II</b>	2. treuil de levage.
<b>Treuil III</b>	Réglage flèche principale/mode derrick.
<b>Treuil V</b>	Réglage fléchette treillis à volée variable.
<b>Poulie en extrémité de mât 55100 lbs</b>	Elle sert au montage au niveau de la tête S et L.

## Équipement additionnel

<b>Stabilisateur additionnel mécanique</b>	Il sert au relevage de longues combinaisons de flèche sans contrepoids derrick.
<b>Stabilisateurs hydrauliques de montage</b>	Ils soulèvent l'engin de base pour le montage/démontage. Ils sont constitués de 4 vérins de calage dont les patins de calage montés sur l'élément central.
<b>Vérin hydraulique de montage</b>	Pour le montage autonome/démontage du train de chenilles.
<b>Dispositif d'extraction des axes</b>	Avec groupe hydraulique mobile. Pour le verrouillage de la machine de base et des éléments intermédiaires S et L.

**D'autres équipements additionnels sont disponibles sur demande. Les équipements de série et les options correspondent à la liste de prix actuelle.**

# Dimensions Encombremment

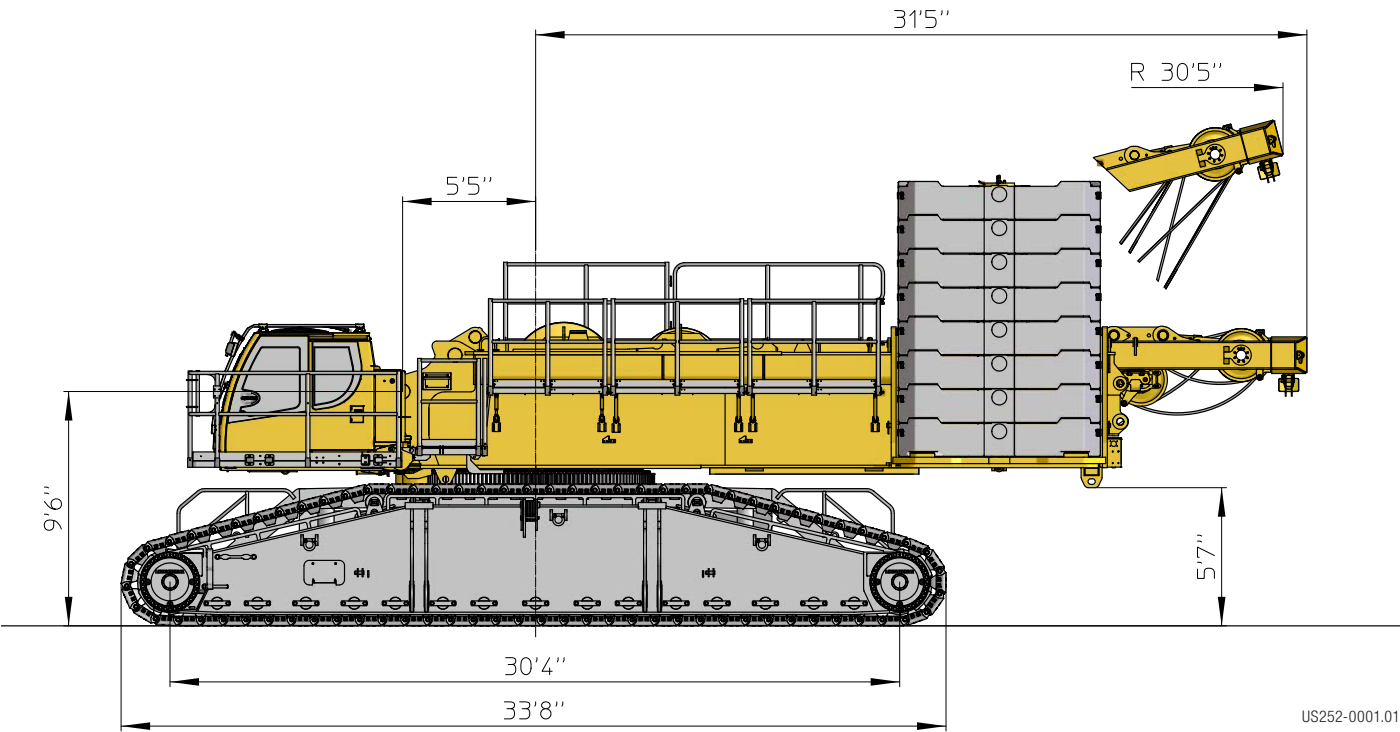
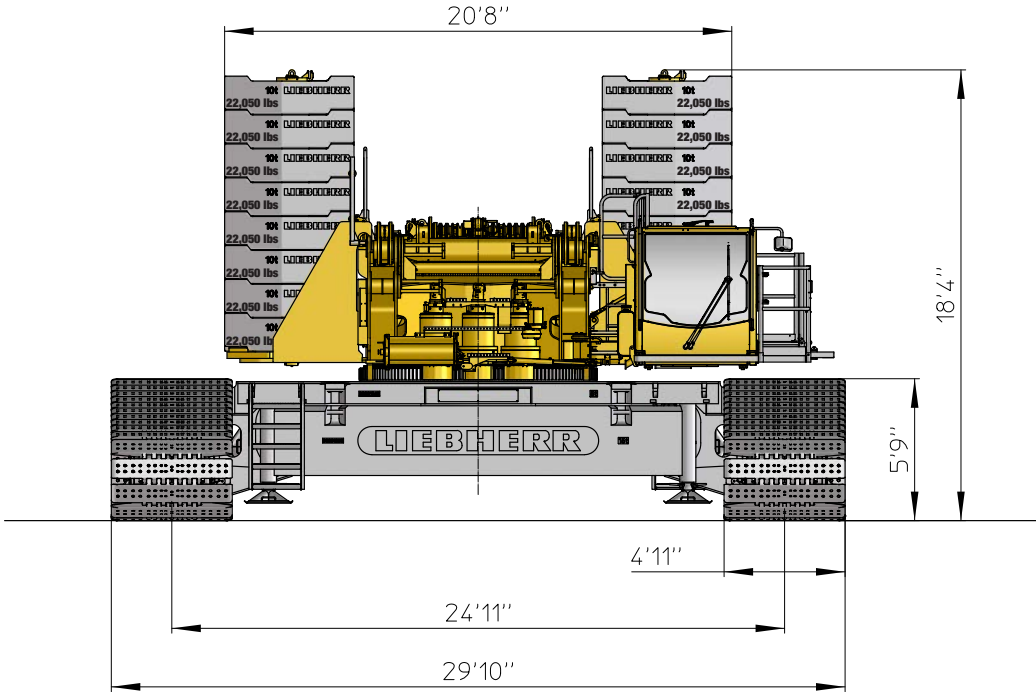

US252-0001.01

# Dimensions Encombremment

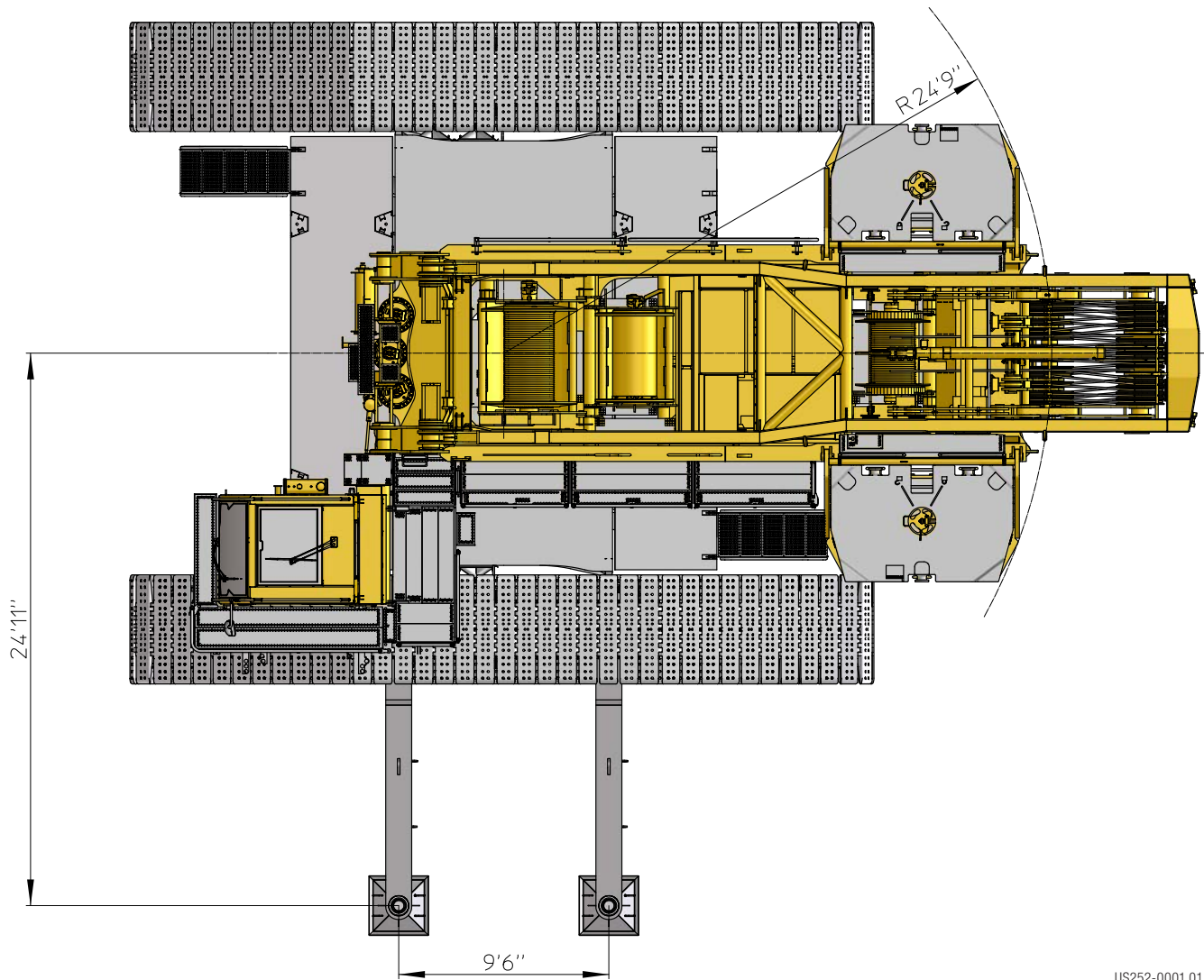

US252-0001.01

# Dimensions Encombremment

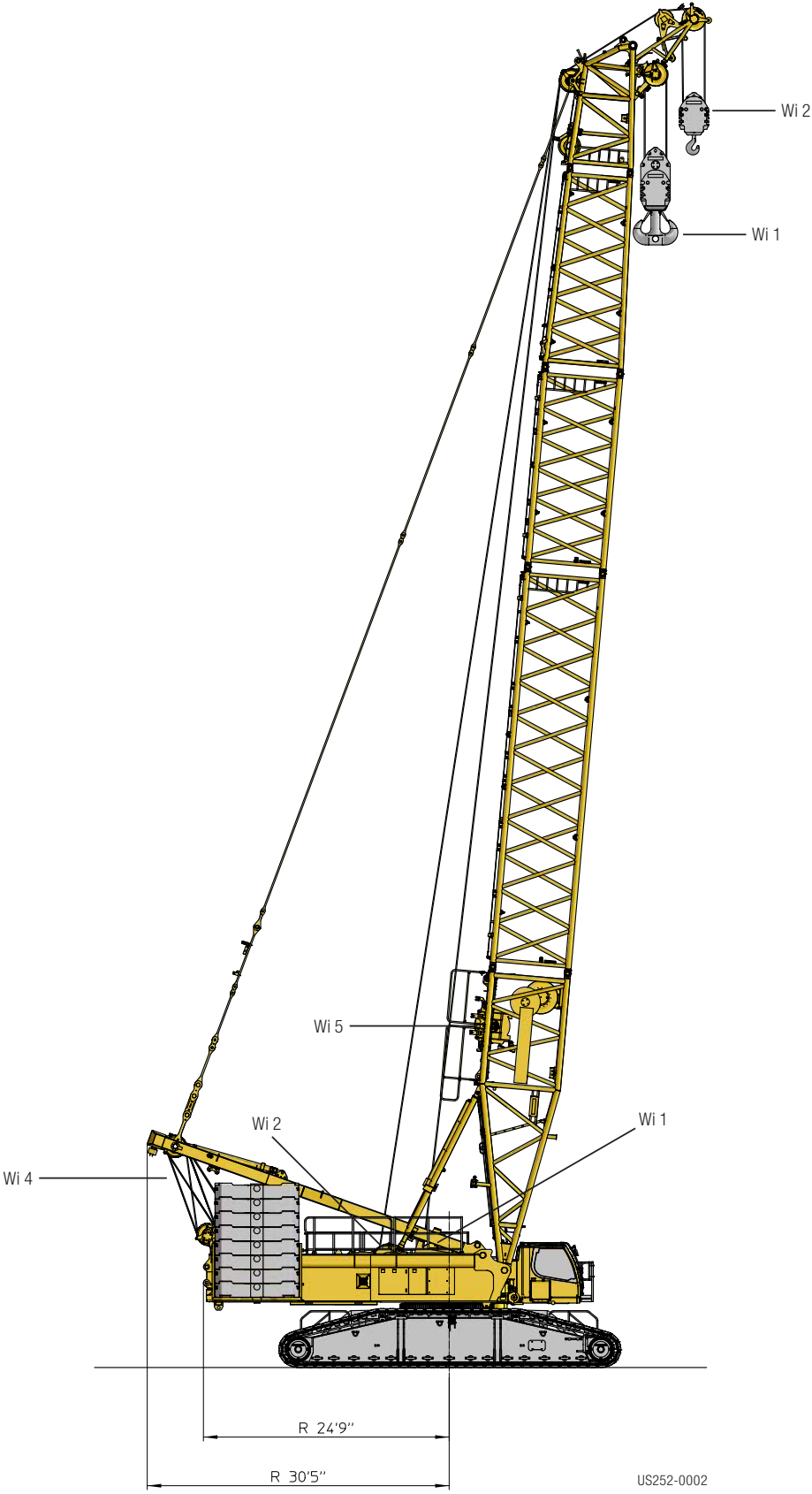

# Dimensions Encombrement

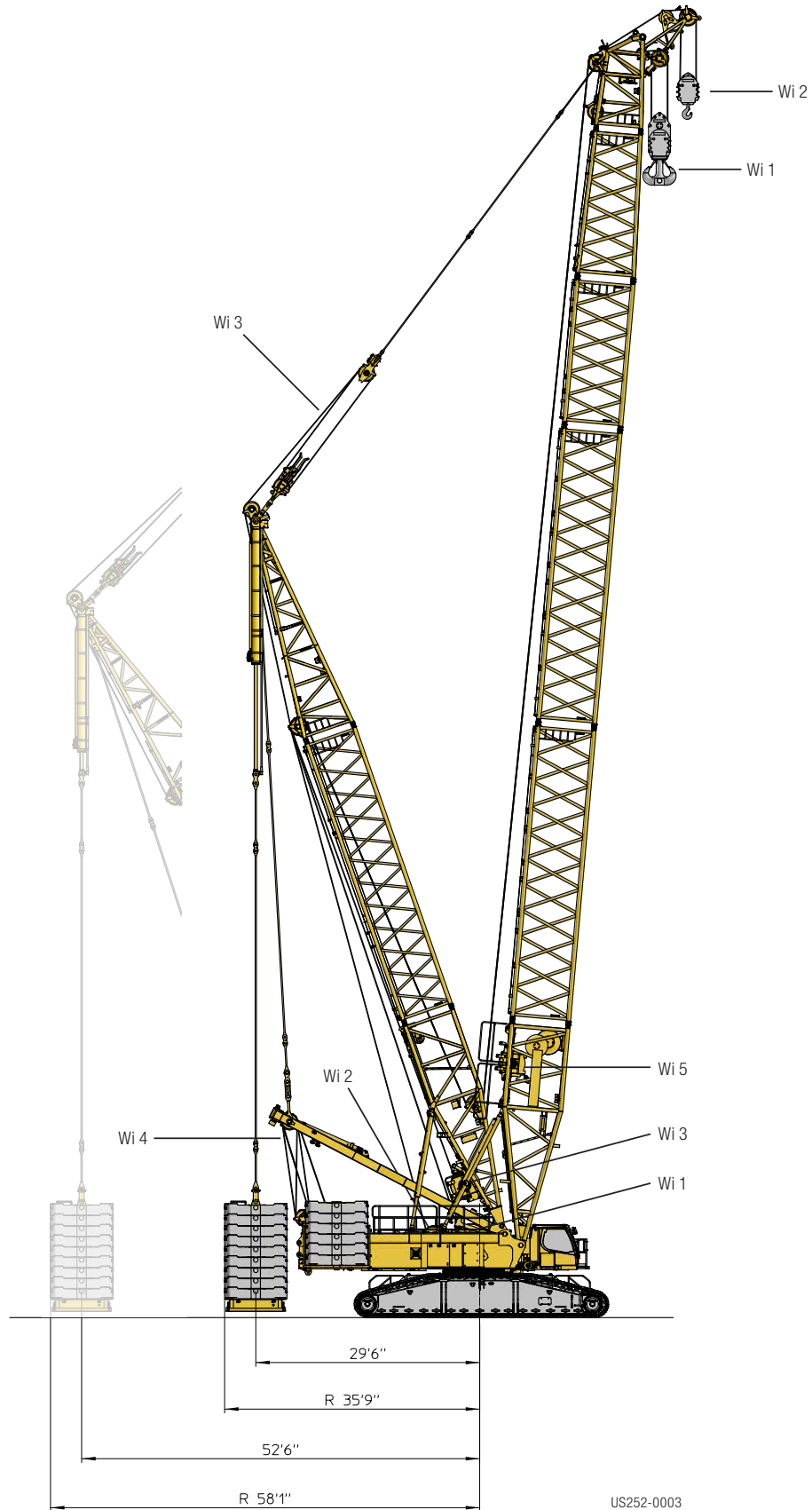

US252-0003



# Dimensions Encombremet

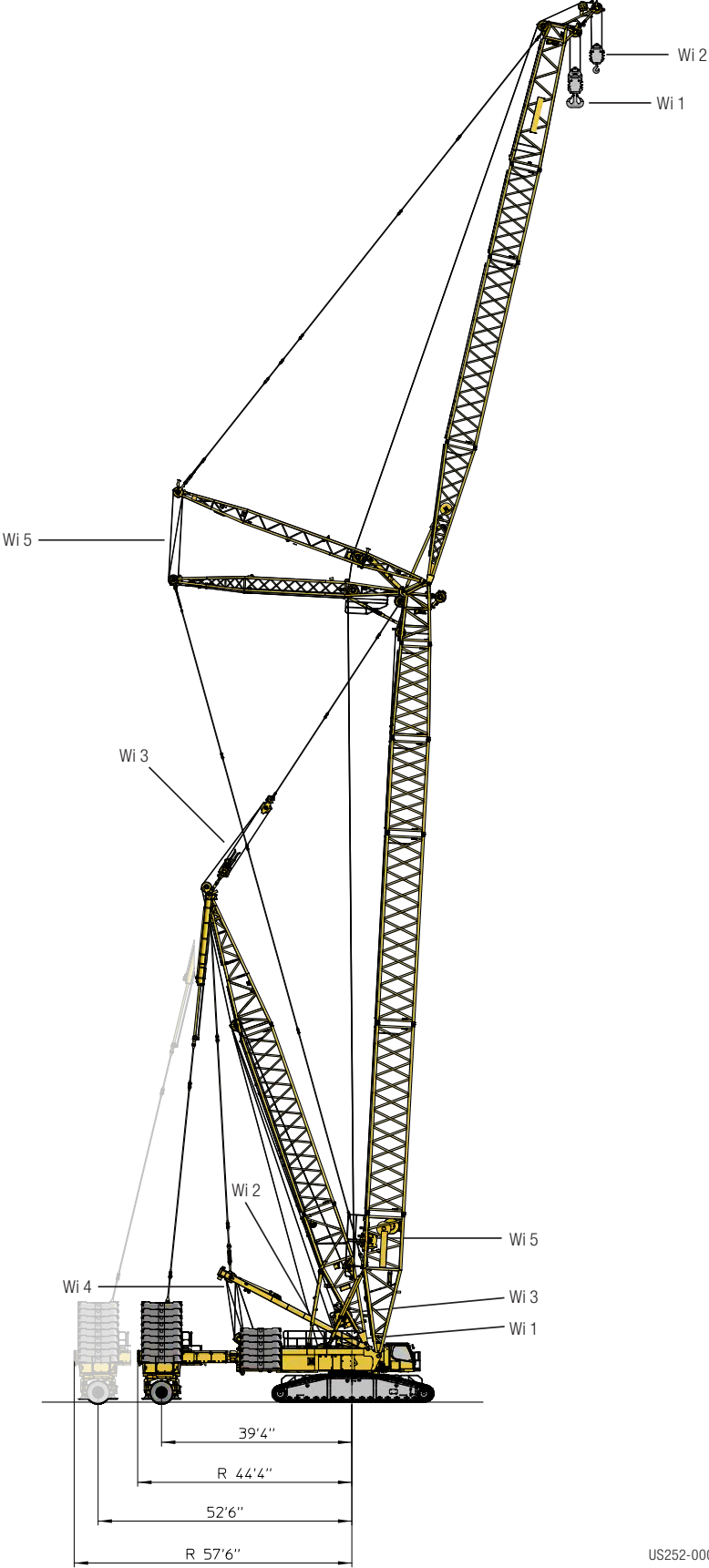





US252-0004



# Crane data

## Dates de la grue

### Winches/Treuil

Drive Mécanismes	Working speeds Vitesses	Max. single line pull Effort au brin maxi.	Rope diameter / length Diamètre / Longueur du câble
	0 – 482 ft/min	40,500 lbs	1.1" / 4,100 ft
	0 – 410 ft/min	28,100 lbs	0.98" / 1,970 ft
	0 – 436 ft/min		
	0 – 2 x 249 ft/min		
	0 – 400 ft/min		

### Working speeds/Vitesses

	Slewing speeds / Vitesses d'orientation	0 – 0,54 rpm
	Travel speeds / Vitesses de translation	0 – 0.95 mph

### Hook blocks/Moufles à crochet

Load Forces de levage	Rope diameter Diamètre du câble	No. of sheaves Poulies	No. of lines Brins	Weight Poids
948,000 lbs	1.1"	13	27	12,125 – 25,350 lbs
705,500 lbs	1.1"	9	19	9,920 – 18,740 lbs
551,200 lbs	1.1"	7	15	8,820 – 15,430 lbs
275,600 lbs	1.1"	3	7	3,305 – 12,125 lbs
138,900 lbs	1.1"	1	3	2,205 – 6,615 lbs

# Transportation plan Plan de transport

Superstructure and crawler center section with SA-frame, winch 4, with assembly jacks  
Partie tournante et partie centrale du porteur avec chevalet SA, treuil 4, avec vérins de montage

**129,650 lbs**

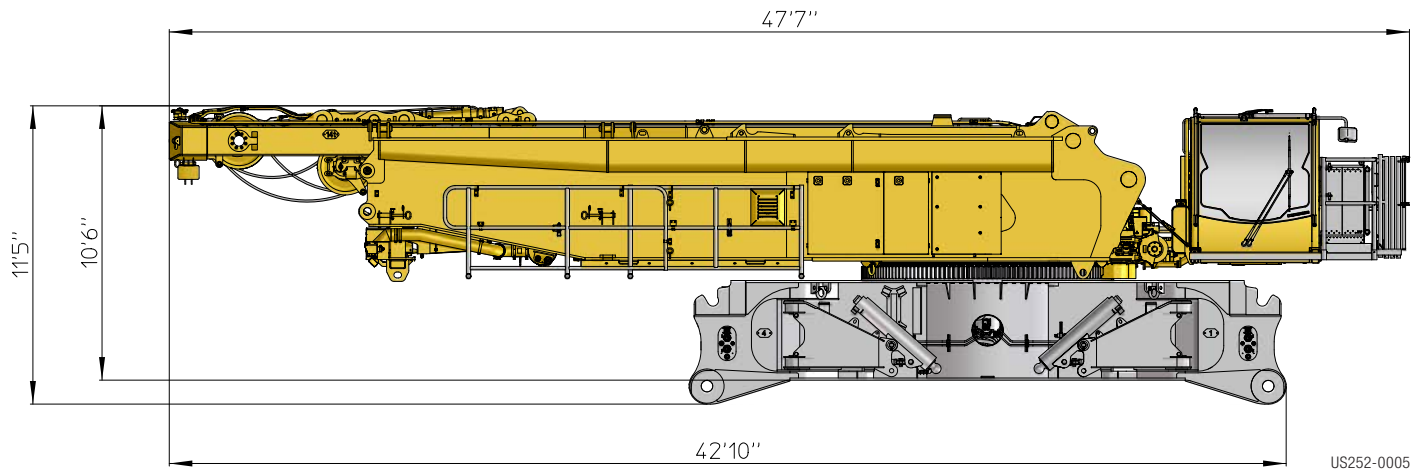

Superstructure and crawler center section, assembly jacks  
Partie tournante et partie centrale du porteur, vérins de montage

**103,000 lbs**

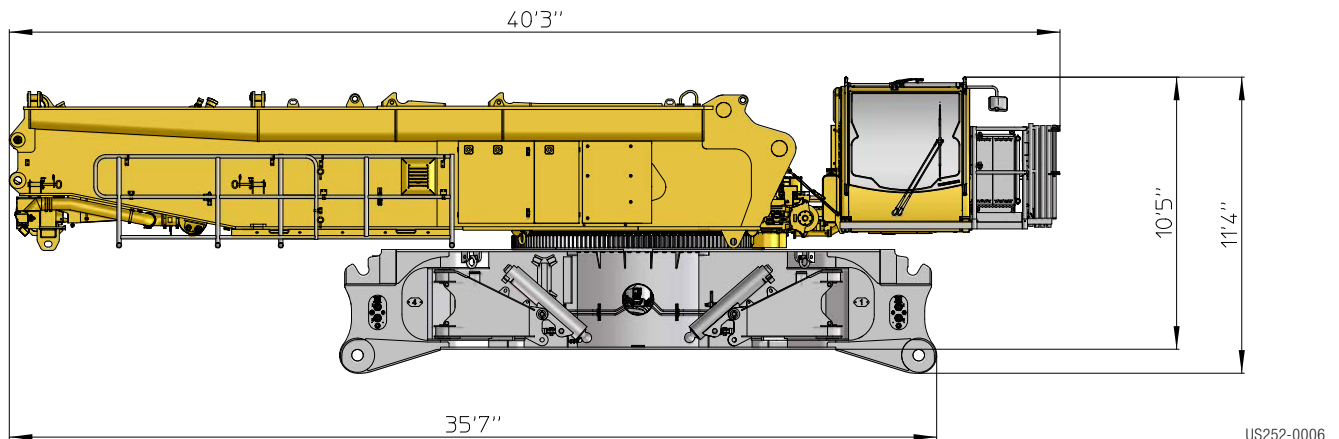

# Transportation plan Plan de transport

SA-frame, winch 4 incl. rope and pulley block  
Chevalet SA, treuil 4 incl. câble et bloc de poulies

**26,675 lbs**

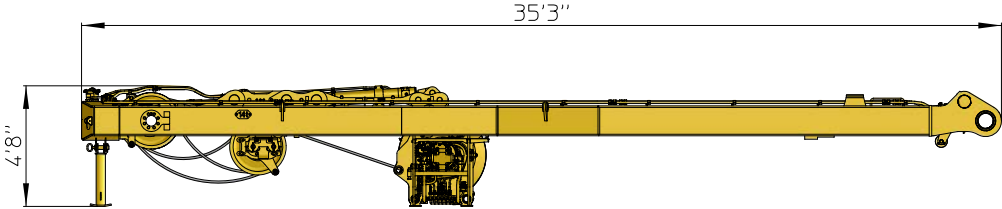

US252-0007

Crawler with track pads 4.9 ft  
Chenille avec pains de chenille de 4.9 ft

**2 x 66,150 lbs**

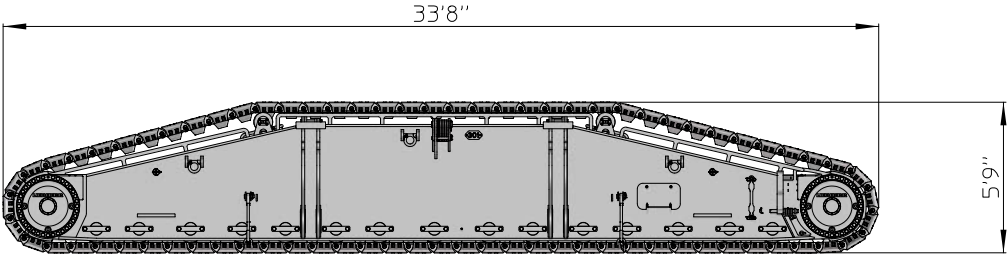

US252-0008

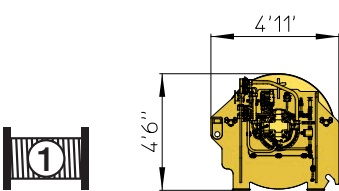

**19,200 lbs**

S252-0009

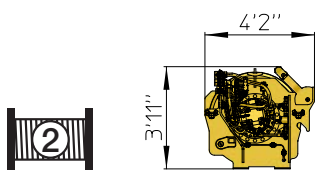

**9,480 lbs**

S252-0010

# Boom/jib combinations

## Configurations de flèche

**S** Main boom, heavy · Flèche principale, lourde

**SL** Main boom, heavy/light · Flèche principale, lourde/légère

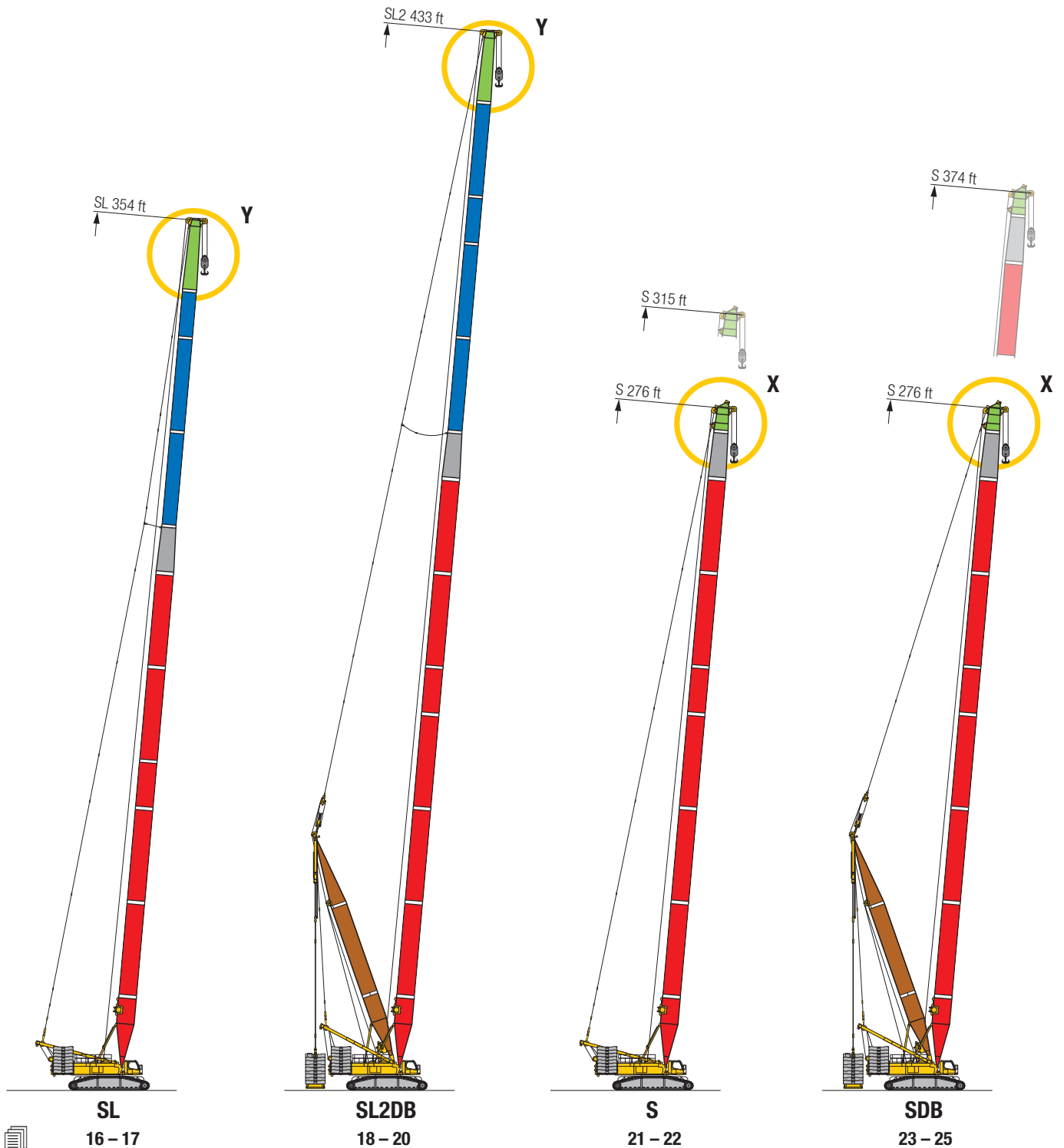

# Boom/jib combinations Configurations de flèche

- W** Luffing jib, heavy · Fléchette, lourde
- D** Derrick · Flèche derrick
- B** Suspended ballast · Lest suspendu
- F** Lattice fly jib · Fléchette treillis fixe

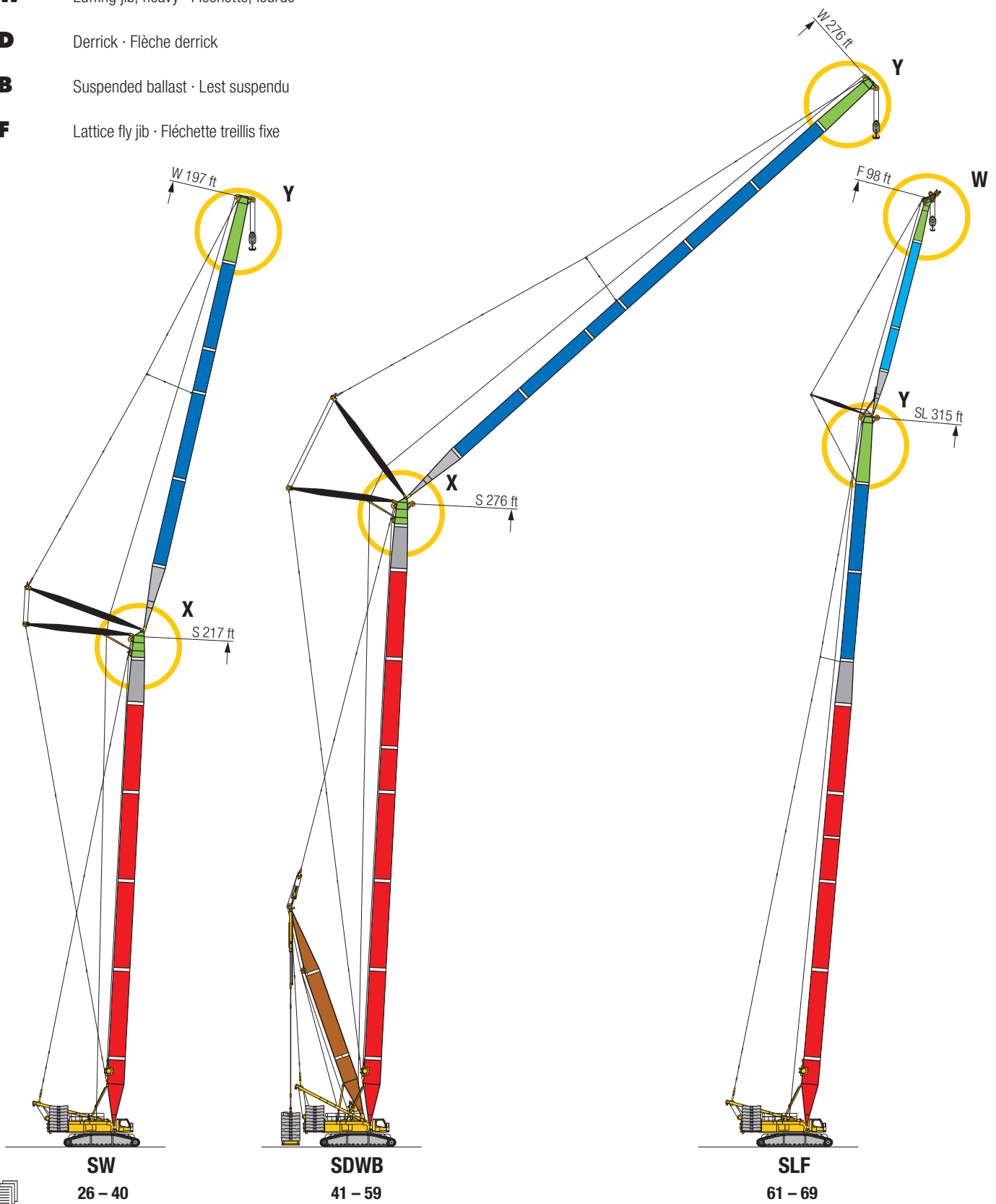

# Boom/jib combinations

## Configurations de flèche

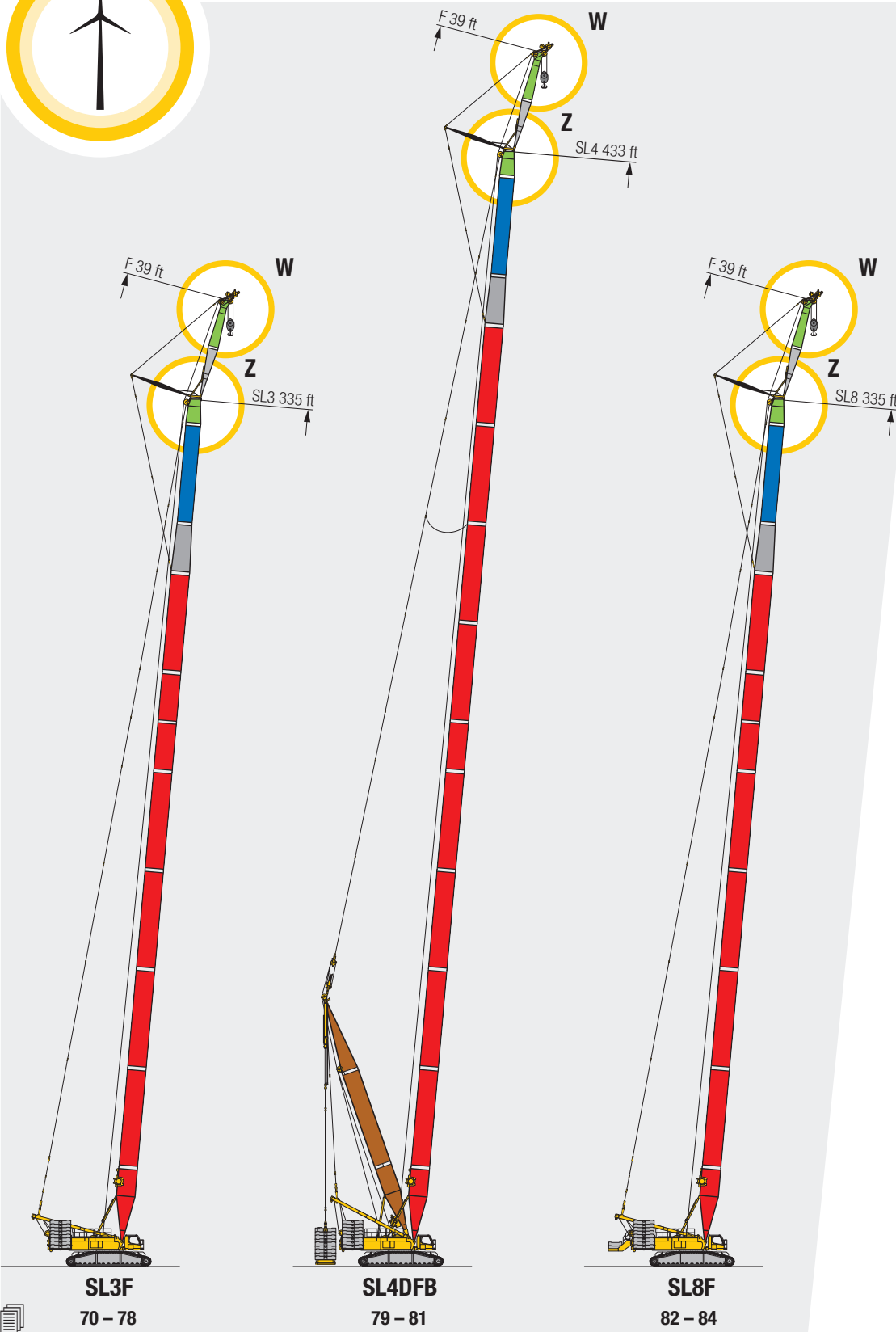

F-Head section  
F-Tête de flèche

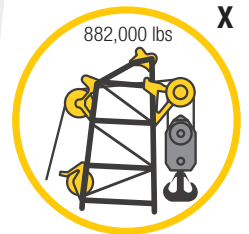

S-Head section  
S-Tête de flèche

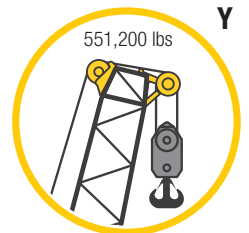

L-Head section  
L-Tête de flèche

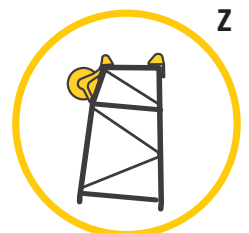

F-adapter head  
x-Tête de flèche

**SL3F**  
70 – 78

**SL4DFB**  
79 – 81

**SL8F**  
82 – 84

US2988.02

# Lifting capacities Forces de levage

SL

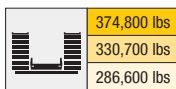

		SL 79 - 354															
ft		79 ft	98 ft	118 ft	138 ft	157 ft	177 ft	197 ft	217 ft	236 ft	256 ft	276 ft	295 ft	315 ft	335 ft	354 ft	ft
16		551															16
17		551															17
18		551	551														18
19		551	551														19
20		551	551	551													20
22		551	551	551	551.0												22
24		551	551	551	551.0	551.0											24
26		551	551	551	551.0	551.0	551.0										26
28		551	551	551	551.0	549.0	489.0										28
30		551	551	547	551.0	547.0	525.0	498.0	415.0								30
32		551	544	549	542.0	514.0	490.0	467.0	402.0	369.0							32
34		541	549	533	506.0	480.0	459.0	438.0	389.0	358.0	315.0						34
36		505	524	498	473.0	451.0	432.0	412.0	376.0	346.0	304.0	321.0					36
38		505	491	467	445.0	424.0	407.0	389.0	363.0	334.0	293.0	316.0	274.0				38
40		476	461	439	419.0	401.0	384.0	368.0	352.0	322.0	282.0	310.0	270.0	240.0			40
45		402	399	383	366.0	351.0	338.0	325.0	315.0	293.0	257.0	281.0	261.0	234.0	209.0	184.0	45
50		344	343	338	324.0	311.0	301.0	289.0	281.0	266.0	235.0	252.0	243.0	227.0	204.0	180.0	50
55		302	300	297	291.0	279.0	270.0	260.0	253.0	241.0	215.0	227.0	220.0	212.0	197.0	176.0	55
60		267	265	263	260.0	252.0	245.0	236.0	230.0	219.0	196.0	207.0	200.0	193.0	186.0	171.0	60
65		239	238	235	232.0	229.0	223.0	215.0	210.0	200.0	180.0	189.0	183.0	177.0	171.0	165.0	65
70		216	214	212	210.0	207.0	205.0	197.0	193.0	183.0	165.0	174.0	168.0	162.0	158.0	153.0	70
75			195	194	191.0	188.0	186.0	182.0	178.0	171.0	151.0	160.0	155.0	150.0	145.0	141.0	75
80			179	177	174.0	172.0	170.0	167.0	165.0	160.0	142.0	148.0	144.0	138.0	134.0	131.0	80
85			165	163	161.0	157.0	156.0	153.0	153.0	149.0	134.0	137.0	133.0	128.0	124.0	121.0	85
90			153	151	149.0	145.0	144.0	141.0	140.0	138.0	127.0	128.0	124.0	119.0	115.0	112.0	90
95				140	137.0	135.0	133.0	130.0	130.0	128.0	121.0	119.0	116.0	111.0	107.0	105.0	95
100				131	128.0	125.0	124.0	121.0	121.0	119.0	115.0	112.0	108.0	104.0	100.0	97.4	100
105				122	120.0	117.0	116.0	113.0	112.0	110.0	107.0	104.0	101.0	96.9	93.6	91.0	105
110					112.0	109.0	108.0	105.0	105.0	103.0	100.0	96.7	94.5	90.7	87.5	85.0	110
115					105.0	102.0	101.0	98.3	97.9	95.9	92.2	90.0	88.1	85.0	81.9	79.5	115
120					99.2	96.2	95.1	92.1	91.8	89.6	87.0	83.8	81.8	79.4	76.7	74.4	120
125						90.6	89.4	86.5	86.1	84.1	81.5	78.3	76.4	73.8	71.8	69.7	125
130						85.5	84.3	81.4	81.0	79.0	76.3	73.1	71.2	68.8	66.9	65.2	130
135						80.8	79.6	76.7	76.3	74.2	71.7	68.5	66.7	64.1	62.1	60.9	135
140						76.6	75.3	72.4	72.0	69.9	67.4	64.2	62.3	59.9	58.0	56.5	140
145							71.4	68.4	68.0	65.9	63.3	60.2	58.3	55.9	53.9	52.7	145
150							67.8	64.7	64.3	62.2	59.6	56.5	54.7	52.2	50.4	49.0	150
155							64.5	61.4	60.9	58.7	56.2	53.0	51.2	48.7	46.9	45.6	155
160								58.3	57.7	55.5	53.0	49.9	48.0	45.6	43.8	42.5	160
165								55.4	54.7	52.6	50.0	46.9	45.0	42.6	40.7	39.4	165
170								52.7	52.0	49.8	47.2	44.1	42.3	39.8	38.0	36.7	170
175									49.4	47.2	44.6	41.5	39.6	37.1	35.4	34.0	175
180									47.0	44.7	42.1	39.0	37.2	34.7	32.9	31.7	180
185									44.7	42.4	39.8	36.7	34.9	32.4	30.6	29.3	185
190									42.7	40.3	37.6	34.6	32.6	30.3	28.5	27.2	190
195										38.3	35.6	32.5	30.6	28.2	26.3	25.1	195
200										36.4	33.7	30.6	28.7	26.2	24.4	23.2	200
205										34.6	31.9	28.8	26.8	24.4	22.6	21.5	205
210											30.1	27.1	25.1	22.6	21.1	20.0	210
215											28.5	25.4	23.5	21.2	19.6	18.6	215
220											27.0	23.9	22.0	19.9	18.3	17.2	220
225												22.4	20.7	18.6	17.0	15.9	225
230												21.2	19.5	17.4	15.8	14.7	230
235												20.1	18.4	16.3	14.7	13.6	235
240												19.1	17.4	15.2	13.6	12.5	240
245													16.3	14.2	12.6	11.4	245
250													15.1	13.2	11.5	10.4	250
255													14.0	12.2	10.5	9.4	255
260														11.1	9.4	8.3	260
265														10.0	8.3	7.2	265
270														9.0	7.3	6.1	270
275															6.3		275

t\_252\_004\_00101\_01\_000 - 00115\_01\_000 / 02101\_01\_000 - 02112\_01\_000 / 04101\_01\_000 - 04112\_01\_000



# Lifting heights Hauteurs de levage

SL

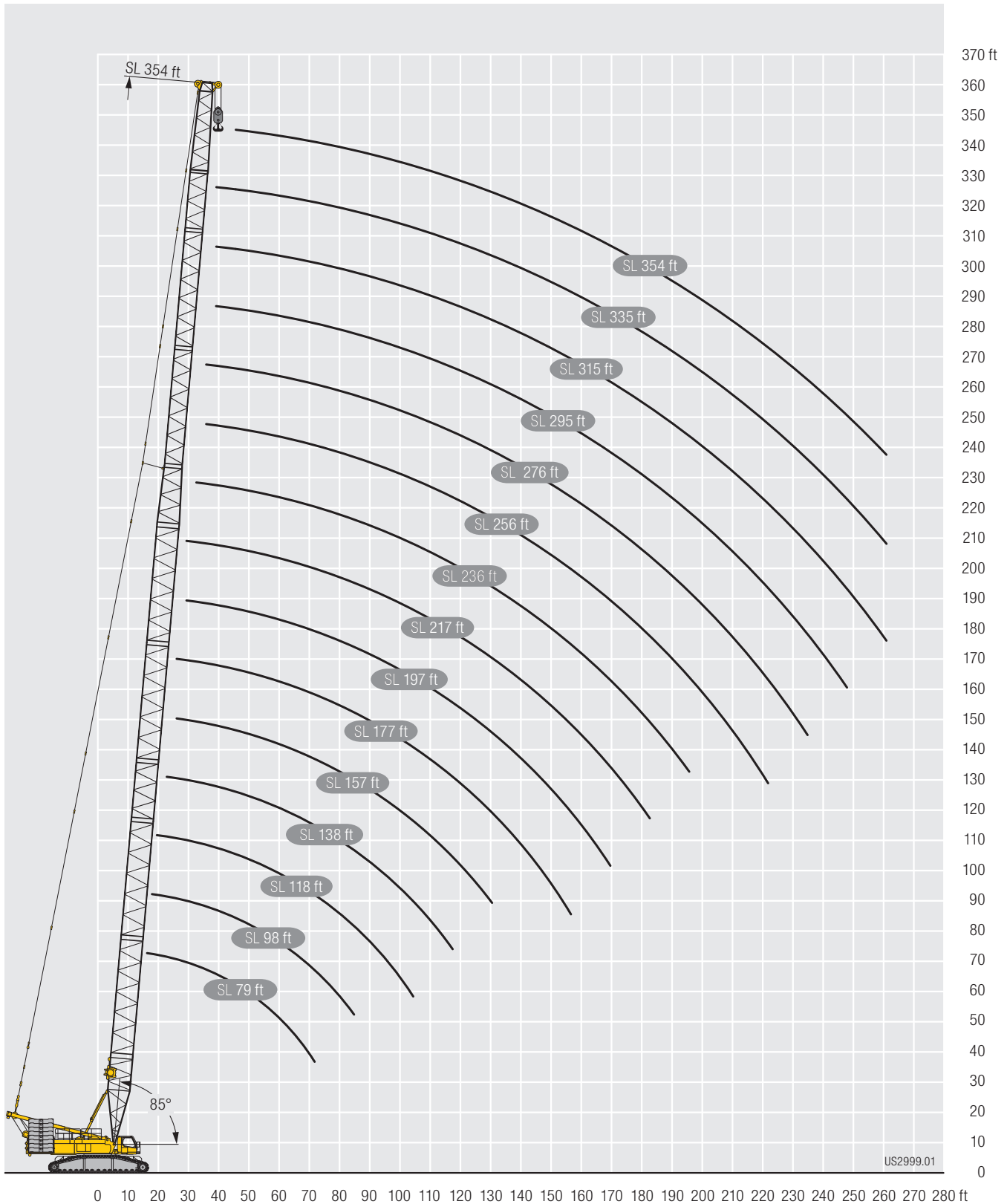

# Lifting capacities Forces de levage

**SL2DB**

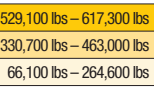

		SL2 118 - 433																
ft		118 ft	138 ft	157 ft	177 ft	197 ft	217 ft	236 ft	256 ft	276 ft	295 ft	315 ft	335 ft	354 ft	374 ft	394 ft	413 ft	433 ft
22	- B	551																
24	- B	551	551.0															
26	- B	551	551.0	551.0														
28	- B	551	551.0	551.0	530.0													
30	- B	550	544.0	519.0	493.0	467.0												
32	- B	538	508.0	483.0	459.0	447.0	415.0											
34	- B	500	474.0	461.0	439.0	419.0	401.0	431.0										
36	- B	467	453.0	432.0	413.0	394.0	377.0	414.0	347.0									
38	- B	447	425.0	407.0	389.0	373.0	357.0	391.0	316.0									
40	- B	421	401.0	384.0	368.0	352.0	337.0	372.0	359.0	342.0	291.0							
45	- B	366	350.0	336.0	323.0	310.0	297.0	334.0	323.0	308.0	299.0	294.0	268.0					
50	- B	323	309.0	298.0	286.0	275.0	265.0	305.0	290.0	281.0	273.0	265.0	256.0	245.0	213.0	191.0		
55	- B	285	277.0	266.0	257.0	247.0	238.0	275.0	268.0	260.0	253.0	240.0	238.0	225.0	217.0	192.0	165.0	143.0
60	- B	252	248.0	241.0	232.0	223.0	215.0	250.0	244.0	236.0	231.0	224.0	217.0	210.0	204.0	191.0	163.0	142.0
65	- B	225	222.0	218.0	211.0	203.0	196.0	228.0	223.0	216.0	212.0	205.0	199.0	193.0	188.0	183.0	162.0	141.0
70	- B	203	200.0	198.0	193.0	186.0	179.0	209.0	205.0	199.0	195.0	189.0	183.0	177.0	173.0	168.0	160.0	140.0
75	- B	185	182.0	179.0	176.0	171.0	165.0	193.0	189.0	183.0	180.0	174.0	170.0	164.0	159.0	156.0	151.0	139.0
80	- B	169	166.0	163.0	161.0	157.0	152.0	178.0	175.0	170.0	167.0	161.0	157.0	152.0	148.0	144.0	140.0	133.0
85	- B	155	152.0	150.0	147.0	144.0	141.0	166.0	163.0	158.0	155.0	150.0	146.0	141.0	137.0	134.0	130.0	127.0
90	- B	144	140.0	138.0	136.0	133.0	129.0	154.0	151.0	147.0	144.0	140.0	136.0	131.0	128.0	125.0	121.0	119.0
95	- B	133	130.0	128.0	125.0	122.0	119.0	143.0	141.0	137.0	135.0	131.0	127.0	122.0	119.0	116.0	112.0	111.0
100	- B	124	121.0	118.0	116.0	113.0	110.0	133.0	132.0	128.0	126.0	122.0	119.0	114.0	111.0	108.0	105.0	103.0
105	- B	116	113.0	110.0	108.0	105.0	102.0	123.0	123.0	120.0	118.0	114.0	111.0	107.0	104.0	101.0	97.9	96.4
110	- B	105	103.0	100.0	97.6	94.7	91.5	115.0	115.0	112.0	111.0	107.0	104.0	100.0	97.2	94.8	91.5	90.1
115	- B	93.0	90.3	87.7	84.9	82.2	80.0	100.0	99.9	97.8	97.4	94.7	91.9	88.3	85.4	83.3	80.2	78.8
120	- B	84.8	82.2	79.4	76.7	74.3	72.0	88.1	87.7	85.6	85.3	83.1	81.1	77.9	75.3	73.3	70.3	68.9
125	- B	75.4	72.7	69.8	67.0	64.3	61.8	77.8	77.5	75.4	75.1	72.9	71.2	68.6	66.5	64.6	61.8	60.4
130	- B	64.7	61.8	59.0	56.3	53.7	51.2	66.6	66.4	64.3	64.0	61.8	60.1	58.3	57.0	54.2	52.9	
135	- B	57.9	54.9	52.0	49.3	46.7	44.2	59.9	59.7	57.6	57.3	55.1	53.4	51.6	49.8	47.9	45.0	43.7
140	- B	51.8	48.9	46.1	43.4	40.8	38.3	54.0	53.8	51.7	51.4	49.2	47.5	45.7	43.8	41.9	39.0	37.7
145	- B	46.4	43.4	40.7	38.1	35.5	33.0	48.6	48.4	46.3	46.0	43.8	42.1	40.3	38.4	36.5	33.6	32.3
150	- B	40.9	37.9	35.2	32.6	30.0	27.5	43.1	42.9	40.8	40.5	38.3	36.6	34.7	32.8	30.9	28.0	26.7
155	- B	36.6	33.6	30.9	28.3	25.7	23.2	38.7	38.5	36.4	36.1	33.9	32.2	30.3	28.4	26.5	23.6	22.3
160	- B	32.3	29.3	26.6	24.0	21.4	18.9	34.3	34.1	32.0	31.7	29.5	27.8	25.9	24.0	22.1	19.2	17.9
165	- B	28.0	25.0	22.3	19.7	17.1	14.6	29.8	29.6	27.5	27.2	25.0	23.3	21.4	19.5	17.6	14.7	13.4
170	- B	24.0	21.0	18.3	15.7	13.1	10.6	25.3	25.1	23.0	22.7	20.5	18.8	16.9	15.0	13.1	10.2	8.9
175	- B	20.0	17.0	14.3	11.7	9.1	6.6	20.8	20.6	18.5	18.2	16.0	14.3	12.4	10.5	8.6	5.7	4.4
180	- B	16.0	13.0	10.3	7.7	5.1	2.6	16.3	16.1	14.0	13.7	11.5	9.8	7.9	6.0	4.1	1.2	0.0

# Lifting capacities Forces de levage

**SL2DB**



286,600 lbs –  
374,800 lbs



529,100 lbs – 617,300 lbs

330,700 lbs – 463,000 lbs

66,100 lbs – 264,600 lbs

		SL2 118 – 433																
ft		118 ft	138 ft	157 ft	177 ft	197 ft	217 ft	236 ft	256 ft	276 ft	295 ft	315 ft	335 ft	354 ft	374 ft	394 ft	413 ft	433 ft
185	- B						36.5	46.6	46.1	44.0	43.7	41.4	39.8	37.5	35.9	34.9	33.0	32.5
							190.0	195.0	196.0	194.0	194.0	193.0	190.0	174.0	158.0	131.0	121.0	100.0
190	- B						34.5	44.2	43.7	41.5	41.2	39.0	37.3	35.1	33.5	32.4	30.4	30.2
							182.0	188.0	189.0	188.0	188.0	186.0	184.0	172.0	155.0	129.0	119.0	98.7
195	- B						41.9	41.4	39.2	38.9	36.6	34.9	32.7	31.0	30.0	28.2	27.8	27.8
							181.0	183.0	181.0	182.0	180.0	178.0	169.0	152.0	126.0	116.0	97.0	97.0
200	- B						39.8	39.2	37.0	36.7	34.4	32.7	30.5	28.9	27.8	25.9	25.6	25.6
							174.0	177.0	175.0	176.0	174.0	173.0	166.0	150.0	125.0	114.0	95.3	95.3
205	- B						37.9	37.2	34.9	34.6	32.3	30.6	28.3	26.8	25.6	23.9	23.7	23.7
							166.0	172.0	170.0	171.0	169.0	168.0	163.0	148.0	123.0	112.0	93.8	93.8
210	- B						35.3	33.0	32.6	30.2	28.6	26.4	24.8	23.8	22.1	21.7	21.7	21.7
							166.0	164.0	165.0	163.0	162.0	159.0	146.0	120.0	111.0	92.2	92.2	92.2
215	- B						33.5	31.1	30.7	28.4	26.7	24.4	22.9	21.9	20.3	20.0	20.0	20.0
							161.0	159.0	160.0	158.0	157.0	155.0	143.0	117.0	109.0	90.8	90.8	90.8
220	- B						31.8	29.3	28.9	26.6	24.9	22.7	21.2	20.3	18.8	18.5	18.5	18.5
							155.0	153.0	155.0	154.0	152.0	150.0	141.0	115.0	107.0	89.5	89.5	89.5
225	- B						27.7	27.3	24.9	23.2	21.2	19.8	18.9	17.3	17.0	17.0	17.0	17.0
							148.0	150.0	149.0	147.0	145.0	138.0	113.0	105.0	88.3	88.3	88.3	88.3
230	- B						26.1	25.7	23.3	21.7	19.7	18.4	17.4	15.9	15.7	15.7	15.7	15.7
							143.0	145.0	144.0	143.0	141.0	135.0	111.0	103.0	86.8	86.8	86.8	86.8
235	- B						24.7	24.2	21.8	20.3	18.4	17.0	16.1	14.6	14.3	14.3	14.3	14.3
							138.0	141.0	140.0	139.0	137.0	132.0	110.0	101.0	85.2	85.2	85.2	85.2
240	- B						23.3	22.7	20.6	19.1	17.2	15.8	14.8	13.2	12.9	12.9	12.9	12.9
							132.0	136.0	136.0	135.0	133.0	129.0	108.0	100.0	89.1	89.1	89.1	89.1
245	- B						21.5	19.4	17.9	15.9	14.6	13.7	11.8	11.4	11.4	11.4	11.4	11.4
							132.0	132.0	130.0	129.0	126.0	107.0	107.0	98.1	81.6	81.6	81.6	81.6
250	- B						20.4	18.2	16.7	14.8	13.4	12.5	10.4	9.9	9.9	9.9	9.9	9.9
							128.0	128.0	126.0	126.0	122.0	105.0	105.0	97.2	79.7	79.7	79.7	79.7
255	- B						19.4	17.2	15.7	13.6	12.3	11.3	9.6	8.6	8.6	8.6	8.6	8.6
							124.0	123.0	121.0	122.0	119.0	104.0	104.0	96.1	78.9	78.9	78.9	78.9
260	- B						16.1	14.5	12.4	11.1	10.0	8.6	7.3	7.3	7.3	7.3	7.3	7.3
							118.0	117.0	118.0	115.0	102.0	102.0	95.0	78.1	78.1	78.1	78.1	78.1
265	- B						15.0	13.4	11.2	9.8	8.8	7.6	6.6	6.6	6.6	6.6	6.6	6.6
							113.0	113.0	114.0	111.0	102.0	102.0	93.4	77.4	77.4	77.4	77.4	77.4
270	- B						13.9	12.3	10.0	8.5	7.6	6.6	5.6	5.6	5.6	5.6	5.6	5.6
							109.0	110.0	110.0	108.0	101.0	101.0	91.4	76.4	76.4	76.4	76.4	76.4
275	- B						11.2	8.9	7.4	6.4	5.4	4.4	3.4	3.4	3.4	3.4	3.4	3.4
							107.0	107.0	105.0	100.0	100.0	90.0	89.9	75.5	75.5	75.5	75.5	75.5
280	- B						10.1	7.7	6.4	5.4	4.4	3.4	2.4	2.4	2.4	2.4	2.4	2.4
							104.0	103.0	102.0	99.0	99.0	89.6	89.6	74.1	74.1	74.1	74.1	74.1
285	- B						9.0	6.7	5.4	4.4	3.4	2.4	1.4	1.4	1.4	1.4	1.4	1.4
							101.0	100.0	99.4	97.1	89.4	89.4	89.4	72.9	72.9	72.9	72.9	72.9
290	- B						8.1	5.8	4.4	3.4	2.4	1.4	0.4	0.4	0.4	0.4	0.4	0.4
							97.8	97.5	96.7	94.9	88.6	88.6	88.6	72.2	72.2	72.2	72.2	72.2
295	- B																	
300	- B																	
305	- B																	
310	- B																	
315	- B																	
320	- B																	
325	- B																	
330	- B																	
335	- B																	
340	- B																	
345	- B																	
350	- B																	
355	- B																	
360	- B																	
365	- B																	
370	- B																	

# Lifting heights Hauteurs de levage

**SL2DB**

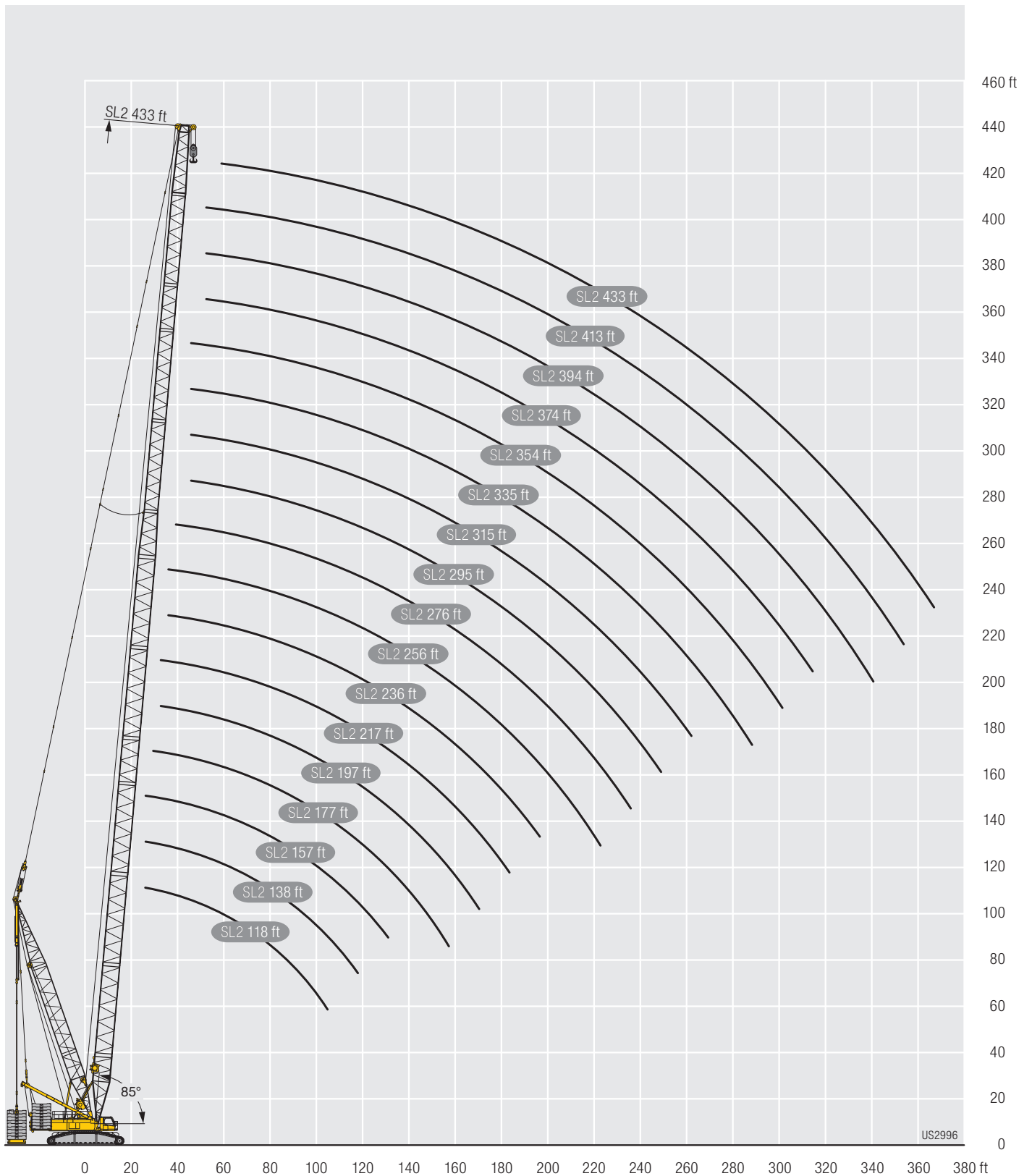

# Lifting capacities Forces de levage

S

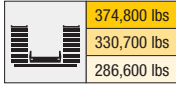

ft	S 79 - 315												ft	
	79 ft	98 ft	118 ft	138 ft	157 ft	177 ft	197 ft	217 ft	236 ft	256 ft	276 ft	295 ft		315 ft
17	882													17
18	882													18
19	882	875												19
20	871	858												20
22	822	816	811											22
24	763	753	767	750.0										24
26	705	720	713	683.0	641.0									26
28	677	672	662	626.0	590.0	557.0								28
30	632	625	611	577.0	545.0	517.0	491.0							30
32	593	584	564	534.0	506.0	482.0	459.0	438.0						32
34	558	545	524	497.0	473.0	451.0	429.0	412.0	394.0					34
36	527	512	489	465.0	443.0	423.0	405.0	387.0	372.0	355.0				36
38	498	482	458	436.0	417.0	398.0	381.0	366.0	351.0	337.0	324.0			38
40	469	452	431	411.0	392.0	376.0	360.0	346.0	333.0	319.0	308.0	282.0		40
45	396	391	373	357.0	343.0	329.0	316.0	305.0	294.0	282.0	273.0	261.0	214.0	45
50	338	335	329	315.0	303.0	291.0	281.0	271.0	261.0	251.0	244.0	235.0	197.0	50
55	295	291	290	281.0	271.0	261.0	251.0	243.0	235.0	226.0	219.0	211.0	182.0	55
60	260	257	255	252.0	244.0	235.0	227.0	220.0	212.0	204.0	199.0	191.0	170.0	60
65	232	230	227	224.0	221.0	214.0	206.0	200.0	193.0	186.0	181.0	174.0	158.0	65
70	210	206	204	202.0	200.0	195.0	188.0	183.0	176.0	170.0	165.0	159.0	147.0	70
75		188	185	183.0	180.0	178.0	173.0	168.0	162.0	156.0	152.0	146.0	137.0	75
80		171	169	166.0	164.0	162.0	159.0	155.0	149.0	143.0	140.0	134.0	127.0	80
85		157	155	153.0	150.0	148.0	146.0	143.0	138.0	132.0	129.0	124.0	118.0	85
90		145	142	141.0	138.0	136.0	133.0	132.0	128.0	123.0	119.0	114.0	110.0	90
95			132	129.0	128.0	125.0	123.0	121.0	118.0	114.0	111.0	106.0	103.0	95
100			123	120.0	118.0	116.0	114.0	112.0	110.0	106.0	103.0	98.3	95.8	100
105			114	111.0	109.0	107.0	105.0	103.0	101.0	98.0	95.6	91.3	89.0	105
110				104.0	102.0	99.8	97.5	95.9	93.6	90.8	89.1	84.9	82.7	110
115				97.4	95.2	93.0	90.6	89.1	86.7	83.9	82.7	79.3	76.9	115
120				91.2	89.0	86.8	84.4	82.9	80.5	77.8	76.5	73.6	71.7	120
125					83.5	81.2	78.7	77.2	74.9	72.2	71.0	68.4	66.8	125
130					78.3	75.9	73.6	72.1	69.8	66.9	65.7	63.1	62.0	130
135					73.7	71.3	68.9	67.4	65.0	62.3	61.1	58.6	57.4	135
140					69.5	66.9	64.6	63.1	60.7	58.0	56.7	54.1	53.1	140
145						62.9	60.6	59.1	56.7	53.9	52.7	50.2	49.1	145
150						59.3	56.9	55.3	52.9	50.2	49.0	46.4	45.4	150
155						55.9	53.5	51.9	49.5	46.8	45.5	43.0	41.9	155
160							50.3	48.7	46.2	43.5	42.3	39.8	38.7	160
165							47.4	45.7	43.3	40.5	39.3	36.7	35.7	165
170							44.6	43.0	40.5	37.8	36.5	34.0	32.9	170
175								40.4	37.9	35.1	33.9	31.3	30.2	175
180								38.0	35.4	32.6	31.4	28.8	27.8	180
185								35.8	33.1	30.4	29.0	26.5	25.4	185
190								33.7	31.0	28.2	26.9	24.3	23.3	190
195									29.0	26.2	24.8	22.4	21.3	195
200									27.1	24.3	22.8	20.6	19.6	200
205									25.4	22.5	21.2	19.0	18.0	205
210										21.0	19.7	17.5	16.5	210
215										19.5	18.3	16.1	15.1	215
220										18.0	17.0	14.8	13.8	220
225											15.8	13.4	12.4	225
230											14.4	12.0	11.0	230
235											13.0	10.5	9.5	235
240											11.7	9.2	8.1	240
245												7.9	6.8	245
250												6.7	5.5	250
255												5.5		255

t\_252\_037\_00101\_01\_000 - 00113\_01\_000 / 02101\_01\_000 - 02110\_01\_000 / 04101\_01\_000 - 04110\_01\_000

# Lifting heights Hauteurs de levage

S

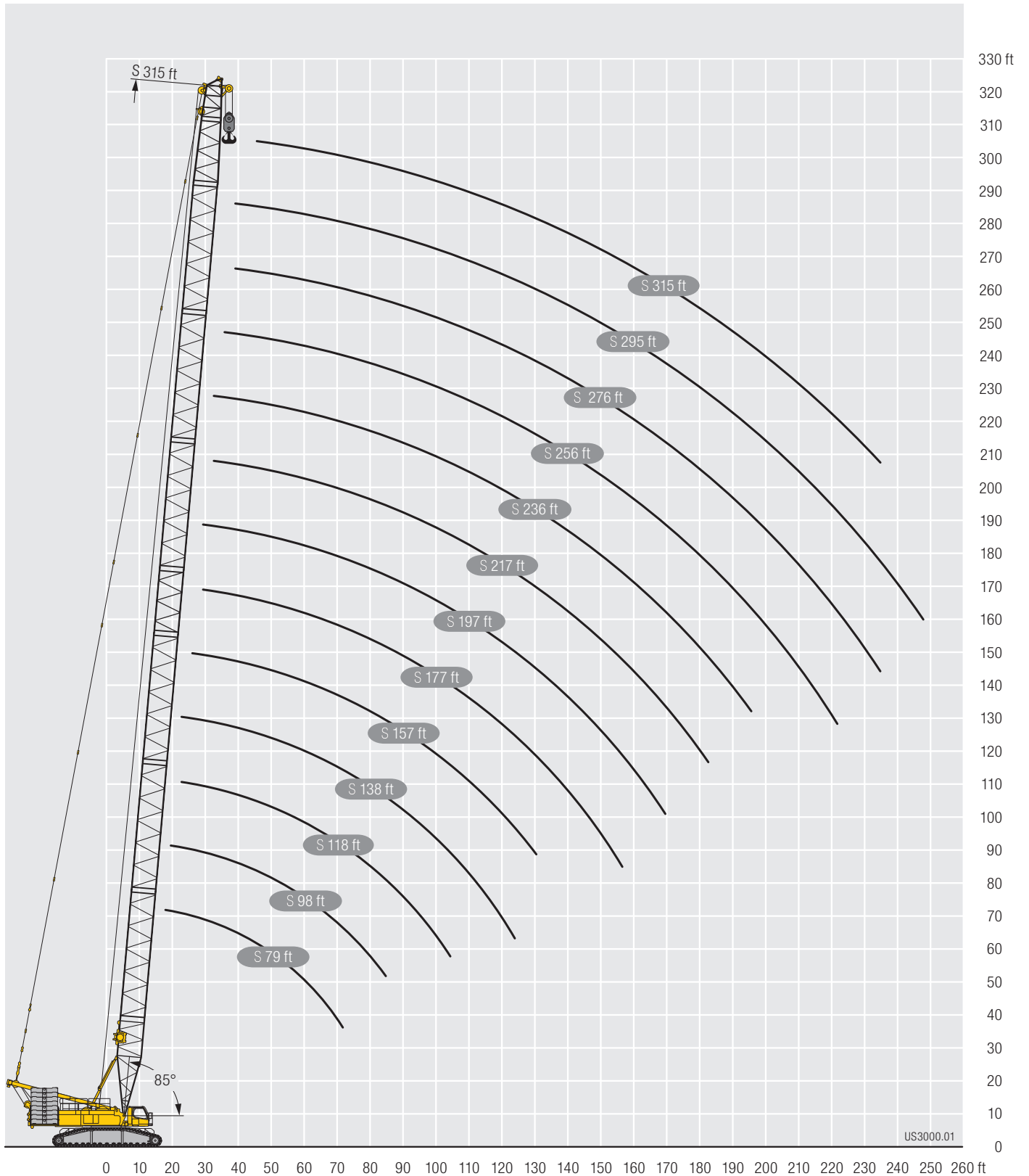

# Lifting capacities Forces de levage

SDB



286,600 lbs –  
374,800 lbs



529,100 lbs – 617,300 lbs  
330,700 lbs – 463,000 lbs

66,100 lbs – 264,600 lbs

		S 118 – 374													
ft		118 ft	138 ft	157 ft	177 ft	197 ft	217 ft	236 ft	256 ft	276 ft	295 ft	315 ft	335 ft	354 ft	374 ft
24	-	755													
	SDB	882													
26	-	685	640.0												
	SDB	882	882.0												
28	-	624	599.0	565.0											
	SDB	882	882.0	882.0											
30	-	586	552.0	522.0	496.0										
	SDB	882	878.0	882.0	818.0										
32	-	541	511.0	484.0	461.0	498.0									
	SDB	882	878.0	876.0	818.0	755.0									
34	-	502	475.0	452.0	431.0	472.0	447.0								
	SDB	882	874.0	876.0	816.0	755.0	659.0								
36	-	468	444.0	424.0	404.0	445.0	427.0	404.0							
	SDB	882	874.0	876.0	814.0	754.0	659.0	583.0							
38	-	439	417.0	398.0	380.0	419.0	404.0	387.0	372.0						
	SDB	882	874.0	867.0	814.0	750.0	659.0	583.0	508.0						
40	-	412	392.0	374.0	359.0	402.0	387.0	367.0	359.0	341.0					
	SDB	882	868.0	850.0	812.0	750.0	655.0	582.0	508.0	445.0					
45	-	357	341.0	326.0	314.0	361.0	342.0	336.0	324.0	307.0	296.0	282.0	276.0		
	SDB	831	809.0	822.0	786.0	742.0	654.0	577.0	503.0	443.0	383.0	333.0	295.0		
50	-	314	300.0	288.0	277.0	320.0	311.0	300.0	289.0	281.0	272.0	257.0	254.0	246.0	217.0
	SDB	794	790.0	772.0	743.0	714.0	651.0	570.0	500.0	438.0	381.0	328.0	294.0	256.0	221.0
55	-	278	267.0	257.0	248.0	287.0	279.0	270.0	261.0	254.0	246.0	238.0	230.0	223.0	214.0
	SDB	732	730.0	718.0	703.0	700.0	651.0	566.0	492.0	437.0	376.0	324.0	293.0	255.0	220.0
60	-	245	240.0	231.0	223.0	260.0	253.0	245.0	237.0	230.0	223.0	216.0	209.0	203.0	196.0
	SDB	683	675.0	666.0	659.0	675.0	632.0	562.0	492.0	429.0	372.0	319.0	292.0	254.0	219.0
65	-	217	215.0	210.0	202.0	236.0	230.0	223.0	216.0	210.0	204.0	198.0	191.0	185.0	179.0
	SDB	637	630.0	619.0	615.0	632.0	615.0	550.0	485.0	428.0	366.0	313.0	292.0	253.0	218.0
70	-	196	192.0	190.0	184.0	216.0	211.0	204.0	198.0	193.0	187.0	181.0	175.0	170.0	164.0
	SDB	591	587.0	579.0	575.0	587.0	581.0	550.0	477.0	421.0	360.0	307.0	289.0	251.0	217.0
75	-	177	174.0	171.0	168.0	199.0	194.0	188.0	182.0	177.0	172.0	167.0	161.0	156.0	151.0
	SDB	549	547.0	543.0	538.0	549.0	544.0	532.0	477.0	416.0	351.0	301.0	288.0	249.0	215.0
80	-	162	158.0	156.0	153.0	183.0	179.0	173.0	168.0	164.0	159.0	154.0	148.0	144.0	139.0
	SDB	508	511.0	509.0	504.0	515.0	510.0	502.0	467.0	411.0	345.0	294.0	286.0	248.0	213.0
85	-	148	145.0	142.0	140.0	169.0	166.0	160.0	155.0	151.0	147.0	143.0	137.0	133.0	129.0
	SDB	469	481.0	477.0	474.0	483.0	481.0	474.0	455.0	398.0	338.0	286.0	281.0	247.0	211.0
90	-	136	133.0	130.0	128.0	155.0	154.0	149.0	144.0	141.0	136.0	132.0	127.0	123.0	119.0
	SDB	433	453.0	449.0	446.0	454.0	453.0	448.0	439.0	395.0	328.0	279.0	278.0	244.0	209.0
95	-	126	123.0	120.0	118.0	143.0	142.0	139.0	134.0	131.0	127.0	123.0	118.0	115.0	110.0
	SDB	400	426.0	425.0	421.0	430.0	428.0	424.0	418.0	391.0	324.0	273.0	275.0	242.0	207.0
100	-	117	114.0	111.0	108.0	132.0	131.0	129.0	125.0	122.0	118.0	115.0	110.0	107.0	102.0
	SDB	368	398.0	402.0	398.0	407.0	404.0	402.0	397.0	380.0	321.0	268.0	270.0	241.0	205.0
105	-	109	106.0	103.0	100.0	123.0	122.0	119.0	117.0	114.0	110.0	107.0	102.0	99.1	95.3
	SDB	337	370.0	381.0	378.0	385.0	383.0	381.0	377.0	367.0	313.0	263.0	266.0	238.0	204.0
110	-		98.4	95.3	92.8	114.0	113.0	111.0	109.0	107.0	103.0	99.7	95.3	92.3	88.6
	SDB		346.0	362.0	360.0	365.0	364.0	362.0	359.0	354.0	311.0	259.0	263.0	234.0	202.0
115	-		91.9	88.8	86.2	106.0	105.0	103.0	101.0	99.5	96.4	93.2	88.8	86.0	82.4
	SDB		323.0	343.0	343.0	346.0	345.0	343.0	341.0	339.0	307.0	256.0	257.0	231.0	201.0
120	-		86.1	83.0	80.3	99.3	98.3	95.9	93.8	92.6	90.1	87.3	82.9	80.2	76.7
	SDB		302.0	324.0	327.0	329.0	328.0	326.0	325.0	323.0	303.0	254.0	249.0	228.0	200.0
125	-			77.6	74.8	92.8	91.8	89.6	87.4	86.3	84.2	81.7	77.5	74.8	71.4
	SDB			305.0	313.0	314.0	313.0	311.0	309.0	308.0	296.0	250.0	245.0	224.0	200.0
130	-			72.7	69.9	87.0	85.9	83.8	81.4	80.3	78.3	76.4	72.6	69.9	66.5
	SDB			287.0	299.0	299.0	299.0	297.0	295.0	294.0	289.0	246.0	239.0	223.0	197.0
135	-			68.4	65.4	81.7	80.6	78.3	76.2	75.1	73.1	71.3	67.6	65.4	62.0
	SDB			270.0	285.0	286.0	286.0	283.0	281.0	281.0	278.0	241.0	233.0	219.0	195.0
140	-			64.4	61.3	76.9	75.7	73.4	71.2	70.0	68.1	66.5	63.3	61.0	57.7
	SDB			254.0	270.0	274.0	274.0	272.0	269.0	268.0	266.0	235.0	226.0	215.0	192.0
145	-				57.5	72.4	71.2	68.9	66.5	65.5	63.6	61.9	59.0	56.9	53.8
	SDB				255.0	262.0	262.0	261.0	258.0	256.0	255.0	228.0	220.0	210.0	189.0
150	-				54.1	68.2	66.9	64.6	62.4	61.3	59.3	57.7	55.0	53.1	49.9
	SDB				241.0	252.0	251.0	250.0	247.0	246.0	244.0	222.0	217.0	207.0	187.0
155	-				50.9	64.4	63.0	60.7	58.5	57.2	55.3	53.8	51.0	49.4	46.5
	SDB				228.0	241.0	242.0	240.0	238.0	236.0	234.0	215.0	213.0	205.0	185.0
160	-					60.8	59.4	57.0	54.7	53.6	51.7	50.1	47.4	45.9	43.1
	SDB					230.0	232.0	230.0	229.0	227.0	225.0	209.0	209.0	201.0	183.0
165	-					57.6	56.1	53.7	51.3	50.2	48.2	46.6	43.9	42.3	39.9
	SDB					219.0	224.0	222.0	220.0	219.0	216.0	203.0	205.0	197.0	180.0

t\_252\_002\_0001\_00\_000 – 00014\_00\_000

# Lifting capacities Forces de levage

SDB

118-374 ft S  
98 ft D  
88,200 lbs  
286,600 lbs - 374,800 lbs  
B  
529,100 lbs - 617,300 lbs  
330,700 lbs - 463,000 lbs  
66,100 lbs - 264,600 lbs

		S 118 - 374														
ft		118 ft	138 ft	157 ft	177 ft	197 ft	217 ft	236 ft	256 ft	276 ft	295 ft	315 ft	335 ft	354 ft	374 ft	
170	- SDB					54.6	52.9	50.5	48.2	47.0	45.0	43.5	40.7	39.3	36.9	
	-					207.0	215.0	214.0	211.0	211.0	208.0	197.0	200.0	192.0	177.0	
175	- SDB						50.1	47.6	45.2	44.0	42.0	40.4	37.7	36.2	33.9	
	-						207.0	206.0	204.0	203.0	201.0	191.0	196.0	188.0	174.0	
180	- SDB						47.4	44.8	42.3	41.2	39.2	37.6	34.9	33.4	31.2	
	-						197.0	199.0	197.0	196.0	194.0	185.0	190.0	184.0	170.0	
185	- SDB						44.8	42.2	39.8	38.5	36.5	34.9	32.2	30.7	28.4	
	-						187.0	192.0	189.0	189.0	187.0	179.0	184.0	179.0	167.0	
190	- SDB						42.5	39.8	37.3	36.0	34.0	32.4	29.8	28.2	26.0	
	-						179.0	185.0	183.0	182.0	180.0	174.0	177.0	174.0	163.0	
195	- SDB							37.5	35.0	33.7	31.6	30.0	27.4	25.9	23.6	
	-							178.0	177.0	176.0	174.0	169.0	171.0	169.0	159.0	
200	- SDB							35.4	32.8	31.4	29.4	27.8	25.1	23.7	21.6	
	-							171.0	171.0	170.0	168.0	165.0	166.0	164.0	155.0	
205	- SDB							33.4	30.7	29.4	27.3	25.7	23.0	21.7	19.8	
	-							163.0	165.0	165.0	163.0	160.0	160.0	159.0	151.0	
210	- SDB								28.8	27.4	25.3	23.7	21.2	19.9	17.9	
	-								159.0	160.0	158.0	155.0	155.0	154.0	146.0	
215	- SDB								27.0	25.5	23.4	21.9	19.6	18.3	16.1	
	-								152.0	154.0	152.0	150.0	149.0	149.0	142.0	
220	- SDB								25.3	23.8	21.7	20.3	18.1	16.7	14.3	
	-								146.0	149.0	148.0	145.0	145.0	144.0	138.0	
225	- SDB									22.2	20.2	18.8	16.6	15.3	12.6	
	-									144.0	143.0	140.0	140.0	139.0	135.0	
230	- SDB									20.8	18.8	17.5	15.2	13.7		
	-									139.0	139.0	135.0	136.0	135.0	131.0	
235	- SDB									19.6	17.4	16.1	13.7	12.1		
	-									134.0	134.0	131.0	132.0	130.0	127.0	
240	- SDB									18.2	16.0	14.6	12.0	10.6		
	-									130.0	130.0	127.0	128.0	126.0	124.0	
245	- SDB										14.6	13.1	10.6	9.2		
	-										126.0	123.0	124.0	122.0	120.0	
250	- SDB										13.2	11.6	9.2	7.8		
	-										122.0	119.0	119.0	118.0	116.0	
255	- SDB										11.9	10.3	7.9	6.4		
	-										117.0	114.0	115.0	114.0	113.0	
260	- SDB											9.1	6.6			
	-											110.0	112.0	111.0	109.0	
265	- SDB											7.8				
	-											105.0	108.0	107.0	105.0	
270	- SDB											6.6				
	-											101.0	104.0	104.0	102.0	
275	- SDB															
	-												101.0	101.0	99.0	
280	- SDB															
	-													97.8	97.9	96.1
285	- SDB															
	-													94.6	95.1	93.2
290	- SDB															
	-													91.7	92.2	90.4
295	- SDB															
	-														89.2	87.6
300	- SDB															
	-														86.4	85.0
305	- SDB															
	-														83.7	82.4
310	- SDB															
	-															79.8
315	- SDB															
	-															76.9
320	- SDB															
	-															73.8
325	- SDB															
	-															70.5

t\_252\_002\_0001\_00\_000 - 00014\_00\_000





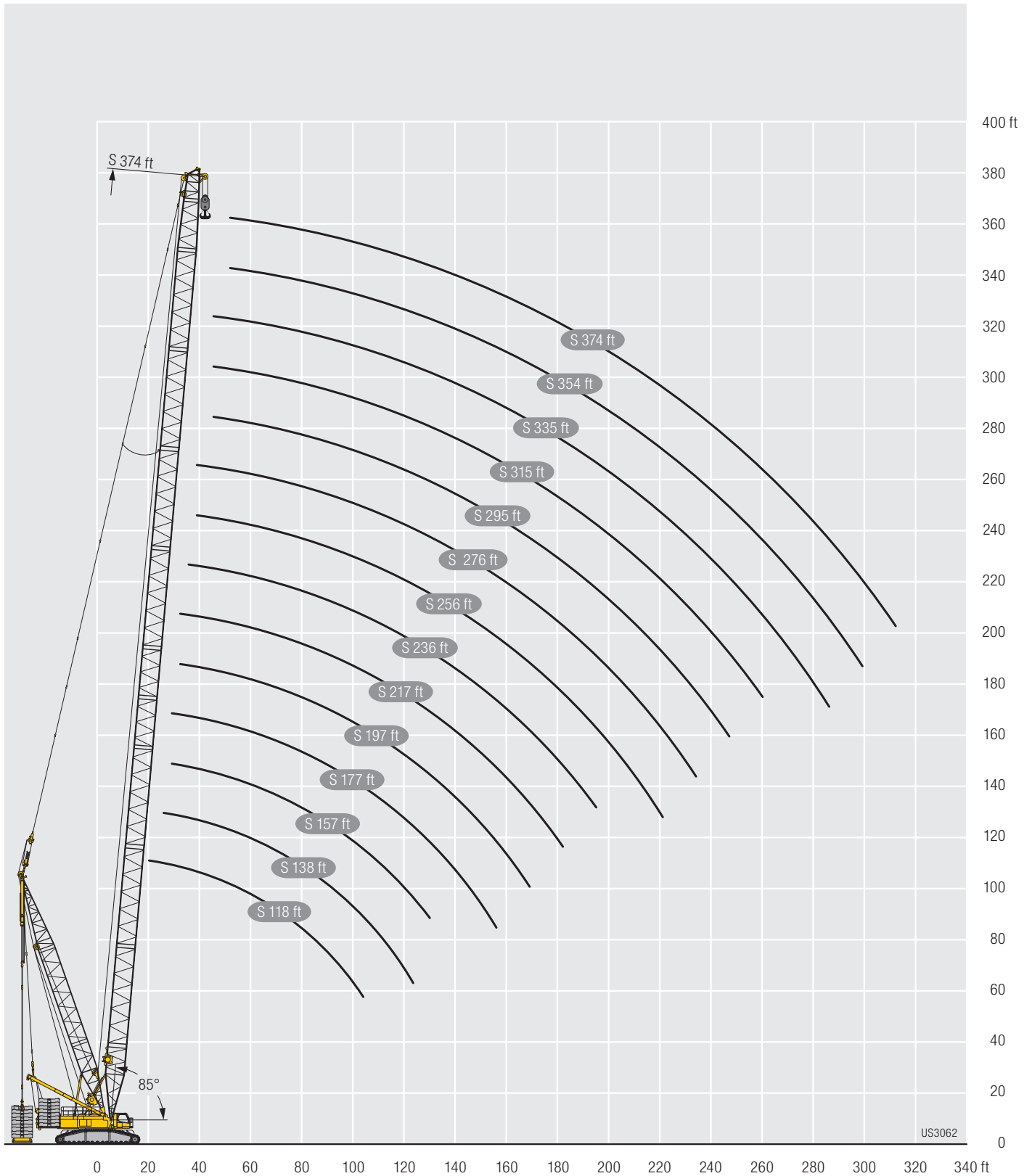

# Lifting heights Hauteurs de levage



SDB



# Lifting capacities Forces de levage

SW

98-217 ft	59-276 ft	88,200 lbs	374,800 lbs
			
			330,700 lbs
			286,600 lbs

	
	60

ft	S 98												ft
	W 59		W 79		W 98		W 118		W 138		W 157		
	87/85*	Wmax	87/85*	Wmax	87/85*	Wmax	87/85*	Wmax	87/85*	Wmax	87/85*	Wmax	
32	537.0	537.0 <sup>(1)</sup>											32
34	503.0	504.0 <sup>(1)</sup>											34
36	474.0	474.0	452.0										36
38	448.0	448.0	427.0	428.0 <sup>(1)</sup>									38
40	424.0	424.0	405.0	405.0 <sup>(1)</sup>	323.0								40
45	375.0	375.0	359.0	359.0 <sup>(2)</sup>	345.0	345.0	332.0						45
50	335.0	335.0 <sup>(3)</sup>	322.0	322.0 <sup>(3)</sup>	310.0	310.0	299.0	299.0	289.0				50
55	303.0	303.0	291.0	291.0	281.0	281.0	271.0	271.0	262.0	262.0 <sup>(1)</sup>	254.0		55
60	277.0	277.0	266.0	266.0	257.0	257.0	248.0	248.0	240.0	240.0	232.0	232.0 <sup>(1)</sup>	60
65	251.0	251.0 <sup>(3)</sup>	245.0	245.0	236.0	236.0	228.0	228.0	221.0	221.0 <sup>(2)</sup>	214.0	214.0	65
70	228.0	228.0	226.0	226.0	218.0	218.0	211.0	211.0	205.0	205.0	198.0	198.0	70
75	205.0*	205.0 <sup>(11)</sup>	206.0	206.0	203.0	203.0	196.0	196.0	190.0	190.0 <sup>(3)</sup>	184.0	184.0	75
80		185.0 <sup>(11)</sup>	190.0	190.0 <sup>(3)</sup>	187.0	187.0 <sup>(3)</sup>	183.0	183.0	178.0	178.0	172.0	172.0	80
85		168.0 <sup>(11)</sup>	175.0	175.0	173.0	173.0	171.0	171.0	166.0	166.0 <sup>(4)</sup>	161.0	161.0 <sup>(3)</sup>	85
90		153.0 <sup>(11)</sup>	163.0	163.0	161.0	161.0	158.0	158.0	156.0	156.0	151.0	151.0	90
95		140.0 <sup>(10)</sup>	149.0*	149.0	150.0	150.0	148.0	148.0	146.0	146.0 <sup>(5)</sup>	143.0	143.0 <sup>(4)</sup>	95
100		129.0 <sup>(11)</sup>		135.0 <sup>(11)</sup>	140.0	140.0 <sup>(10)</sup>	138.0	138.0 <sup>(7)</sup>	136.0	136.0	134.0	134.0	100
105		118.0 <sup>(11)</sup>		125.0 <sup>(11)</sup>	131.0	131.0 <sup>(11)</sup>	129.0	129.0	127.0	127.0 <sup>(6)</sup>	125.0	125.0	105
110		107.0 <sup>(9)</sup>		115.0 <sup>(11)</sup>	124.0	124.0	122.0	122.0	120.0	120.0	117.0	117.0 <sup>(5)</sup>	110
115		99.2 <sup>(9)</sup>		107.0 <sup>(11)</sup>		112.0 <sup>(11)</sup>	115.0	115.0	113.0	113.0	111.0	111.0	115
120		91.3 <sup>(9)</sup>		98.8 <sup>(11)</sup>		104.0 <sup>(11)</sup>	108.0	108.0	106.0	106.0	104.0	104.0 <sup>(6)</sup>	120
125		83.6 <sup>(7)</sup>		91.0 <sup>(11)</sup>		96.6 <sup>(11)</sup>	103.0	103.0	101.0	101.0	98.4	98.4	125
130		77.4 <sup>(7)</sup>		83.3 <sup>(9)</sup>		89.3 <sup>(11)</sup>	97.4	97.4	95.3	95.3	93.2	93.2	130
135		71.2 <sup>(7)</sup>		77.4 <sup>(9)</sup>		83.4 <sup>(11)</sup>		88.1 <sup>(11)</sup>	90.5	90.5	88.4	88.4	135
140				71.6 <sup>(9)</sup>		77.5 <sup>(11)</sup>		81.9 <sup>(11)</sup>	86.1	86.1	84.0	84.0	140
145				65.6 <sup>(7)</sup>		71.7 <sup>(11)</sup>		76.5 <sup>(11)</sup>	82.0	82.0	79.9	79.9	145
150				61.0 <sup>(7)</sup>		65.7 <sup>(9)</sup>		71.1 <sup>(11)</sup>	78.3	78.3	76.1	76.1	150
155				56.3 <sup>(7)</sup>		61.1 <sup>(9)</sup>		66.5 <sup>(11)</sup>		70.3 <sup>(11)</sup>	72.6	72.6	155
160						56.5 <sup>(9)</sup>		61.9 <sup>(11)</sup>		65.6 <sup>(11)</sup>	69.3	69.3	160
165						51.7 <sup>(7)</sup>		57.3 <sup>(11)</sup>		61.3 <sup>(11)</sup>	66.3	66.3	165
170						48.0 <sup>(7)</sup>		52.4 <sup>(9)</sup>		57.1 <sup>(11)</sup>	63.6	63.6	170
175						44.3 <sup>(7)</sup>		48.7 <sup>(9)</sup>		53.3 <sup>(11)</sup>		56.3 <sup>(11)</sup>	175
180								45.0 <sup>(9)</sup>		49.6 <sup>(11)</sup>		52.7 <sup>(11)</sup>	180
185								40.9 <sup>(7)</sup>		45.8 <sup>(11)</sup>		49.2 <sup>(11)</sup>	185
190								37.9 <sup>(7)</sup>		41.7 <sup>(9)</sup>		45.8 <sup>(11)</sup>	190
195								34.8 <sup>(7)</sup>		38.6 <sup>(9)</sup>		42.7 <sup>(11)</sup>	195
200										35.5 <sup>(9)</sup>		39.6 <sup>(11)</sup>	200
205										31.9 <sup>(7)</sup>		36.5 <sup>(11)</sup>	205
210										29.4 <sup>(7)</sup>		32.8 <sup>(9)</sup>	210
215										26.8 <sup>(7)</sup>		30.1 <sup>(9)</sup>	215
220												27.5 <sup>(9)</sup>	220
225												24.5 <sup>(7)</sup>	225
230												22.4 <sup>(7)</sup>	230
235												20.4 <sup>(7)</sup>	235

1) 12°; 2) 17°; 3) 22°; 4) 27°; 5) 32°; 6) 37°; 7) 42°; 8) 47°; 9) 52°; 10) 57°; 11) 62°

# Lifting capacities Forces de levage

SW





ft	S 98												ft
	W 177		W 197		W 217		W 236		W 256		W 276		
	87/85*	Wmax	87/85*	Wmax	87/85*	Wmax	87/85*	Wmax	87/85*	Wmax	87/85*	Wmax	
60	225.0												60
65	208.0	208.0	202.0										65
70	192.0	192.0	187.0	187.0 <sup>(1)</sup>	181.0								70
75	179.0	179.0	174.0	174.0	169.0	169.0	165.0						75
80	167.0	167.0	163.0	163.0	157.0	157.0	154.0	154.0 <sup>(1)</sup>	147.0				80
85	157.0	157.0	153.0	153.0	148.0	148.0	144.0	144.0	140.0	140.0 <sup>(1)</sup>	123.0		85
90	147.0	147.0	143.0	143.0	139.0	139.0	135.0	135.0	132.0	132.0	121.0	121.0	90
95	138.0	138.0 <sup>(3)</sup>	135.0	135.0	131.0	131.0	127.0	127.0	124.0	124.0	119.0	119.0	95
100	131.0	131.0	128.0	128.0 <sup>(3)</sup>	123.0	123.0	120.0	120.0 <sup>(2)</sup>	117.0	117.0	113.0	113.0	100
105	123.0	123.0 <sup>(4)</sup>	121.0	121.0	116.0	116.0	114.0	114.0	110.0	110.0 <sup>(2)</sup>	107.0	107.0	105
110	115.0	115.0	114.0	114.0	110.0	110.0 <sup>(3)</sup>	108.0	108.0	105.0	105.0	101.0	101.0	110
115	108.0	108.0	107.0	107.0 <sup>(4)</sup>	104.0	104.0	102.0	102.0	99.1	99.1	96.0	96.0	115
120	102.0	102.0 <sup>(5)</sup>	101.0	101.0	98.4	98.4	96.9	96.9	94.0	94.0	91.0	91.0	120
125	96.5	96.5	95.2	95.2	92.7	92.7	91.5	91.5	89.3	89.3	86.5	86.5	125
130	91.3	91.3	90.0	90.0	87.5	87.5	86.4	86.4	84.5	84.5	82.1	82.1	130
135	86.5	86.5	85.3	85.3	82.8	82.8	81.6	81.6	79.8	79.8	77.8	77.8	135
140	82.1	82.1	80.8	80.8	78.4	78.4	77.2	77.2	75.5	75.5	73.6	73.6	140
145	78.0	78.0	76.8	76.8	74.4	74.4	73.2	73.2	71.4	71.4	69.5	69.5	145
150	74.2	74.2	73.0	73.0	70.6	70.6	69.5	69.5	67.7	67.7	65.9	65.9	150
155	70.6	70.6	69.5	69.5	67.1	67.1	65.9	65.9	64.3	64.3	62.4	62.4	155
160	67.4	67.4	66.2	66.2	63.8	63.8	62.7	62.7	61.0	61.0	59.2	59.2	160
165	64.3	64.3	63.1	63.1	60.8	60.8	59.7	59.7	58.0	58.0	56.2	56.2	165
170	61.5	61.5	60.2	60.2	57.9	57.9	56.8	56.8	55.1	55.1	53.3	53.3	170
175	58.8	58.8 <sup>(11)</sup>	57.6	57.6	55.3	55.3	54.1	54.1	52.5	52.5	50.7	50.7	175
180	56.3	56.3	55.1	55.1	52.8	52.8	51.6	51.6	49.9	49.9	48.2	48.2	180
185	54.0	54.0	52.7	52.7	50.4	50.4	49.3	49.3	47.6	47.6	45.8	45.8	185
190	52.1	52.1	50.5	50.5	48.2	48.2	47.0	47.0	45.4	45.4	43.7	43.7	190
195		45.3 <sup>(11)</sup>	48.4	48.4	46.1	46.1	44.9	44.9	43.3	43.3	41.6	41.6	195
200		42.3 <sup>(11)</sup>	46.5	46.5	44.1	44.1	43.0	43.0	41.3	41.3	39.6	39.6	200
205		39.3 <sup>(11)</sup>	44.7	44.7	42.3	42.3	41.1	41.1	39.4	39.4	37.7	37.7	205
210		36.6 <sup>(11)</sup>	41.7*	41.7	40.5	40.5	39.3	39.3	37.6	37.6	35.9	35.9	210
215		33.9 <sup>(11)</sup>		36.8 <sup>(11)</sup>	38.8	38.8	37.6	37.6	35.9	35.9	34.2	34.2	215
220		31.3 <sup>(11)</sup>		34.3 <sup>(11)</sup>	37.3	37.3	36.0	36.0	34.3	34.3	32.6	32.6	220
225		28.6 <sup>(11)</sup>		31.8 <sup>(11)</sup>	35.9	35.9	34.5	34.5	32.8	32.8	31.1	31.1	225
230		25.4 <sup>(9)</sup>		29.5 <sup>(11)</sup>	33.4*	33.4	33.1	33.1	31.3	31.3	29.7	29.7	230
235		23.3 <sup>(9)</sup>		27.2 <sup>(11)</sup>		28.7 <sup>(11)</sup>	31.7	31.7	29.9	29.9	28.3	28.3	235
240		21.1 <sup>(9)</sup>		24.9 <sup>(11)</sup>		26.5 <sup>(11)</sup>	30.5	30.5	28.6	28.6	27.0	27.0	240
245		18.5 <sup>(7)</sup>		22.6 <sup>(11)</sup>		24.4 <sup>(11)</sup>	29.3	29.3	27.4	27.4	25.7	25.7	245
250		16.8 <sup>(7)</sup>		19.9 <sup>(9)</sup>		22.6 <sup>(11)</sup>	27.1*	27.1	26.2	26.2	24.5	24.5	250
255		15.1 <sup>(7)</sup>		18.3 <sup>(9)</sup>		20.8 <sup>(11)</sup>		22.8 <sup>(11)</sup>	25.0	25.0	23.4	23.4	255
260				16.6 <sup>(9)</sup>		19.0 <sup>(11)</sup>		21.1 <sup>(11)</sup>	24.0	24.0	22.3	22.3	260
265				14.0 <sup>(7)</sup>		17.3 <sup>(11)</sup>		19.4 <sup>(11)</sup>	23.0	23.0	21.4	21.4	265
270				12.3 <sup>(7)</sup>		14.6 <sup>(9)</sup>		17.9 <sup>(11)</sup>	21.3*	21.3	20.6	20.6	270
275				10.6 <sup>(7)</sup>		13.1 <sup>(9)</sup>		16.4 <sup>(11)</sup>		17.6 <sup>(11)</sup>	19.8	19.8	275
280						11.5 <sup>(9)</sup>		14.9 <sup>(11)</sup>		16.2 <sup>(11)</sup>	19.0	19.0	280
285						9.0 <sup>(7)</sup>		13.4 <sup>(11)</sup>		14.7 <sup>(11)</sup>	18.4	18.4	285
290						7.4 <sup>(7)</sup>		10.6 <sup>(9)</sup>		13.3 <sup>(11)</sup>	16.9*	16.9	290
295								9.1 <sup>(9)</sup>		11.8 <sup>(11)</sup>		13.3 <sup>(11)</sup>	295
300								7.5 <sup>(9)</sup>		10.3 <sup>(11)</sup>		12.1 <sup>(11)</sup>	300
305										8.8 <sup>(11)</sup>		10.7 <sup>(11)</sup>	305
310												9.3 <sup>(11)</sup>	310
315												7.8 <sup>(11)</sup>	315

1) 12°; 2) 17°; 3) 22°; 4) 27°; 5) 32°; 6) 37°; 7) 42°; 8) 47°; 9) 52°; 10) 57°; 11) 62°

# Lifting capacities Forces de levage

SW

98-217 ft	59-276 ft	88,200 lbs	374,800 lbs
			330,700 lbs
			286,600 lbs

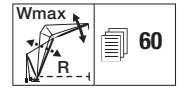

ft	S 118												ft
	W 59		W 79		W 98		W 118		W 138		W 157		
	87/85*	Wmax	87/85*	Wmax	87/85*	Wmax	87/85*	Wmax	87/85*	Wmax	87/85*	Wmax	
32	508.0												32
34	478.0	478.0 <sup>(1)</sup>											34
36	451.0	451.0											36
38	427.0	427.0 <sup>(2)</sup>	408.0	408.0 <sup>(1)</sup>									38
40	405.0	405.0	388.0	388.0 <sup>(1)</sup>									40
45	359.0	359.0	345.0	345.0 <sup>(2)</sup>	331.0	331.0 <sup>(1)</sup>							45
50	322.0	322.0	310.0	310.0	298.0	298.0	288.0	288.0 <sup>(1)</sup>					50
55	292.0	292.0 <sup>(6)</sup>	281.0	281.0	271.0	271.0	262.0	262.0	253.0	253.0 <sup>(1)</sup>			55
60	267.0	267.0	257.0	257.0	248.0	248.0	240.0	240.0	232.0	232.0	224.0	224.0 <sup>(1)</sup>	60
65	246.0	246.0 <sup>(9)</sup>	237.0	237.0	228.0	228.0	221.0	221.0	214.0	214.0 <sup>(2)</sup>	207.0	207.0	65
70	225.0	225.0 <sup>(11)</sup>	219.0	219.0	211.0	211.0	205.0	205.0	198.0	198.0	192.0	192.0	70
75	203.0*	203.0	204.0	204.0	196.0	196.0 <sup>(5)</sup>	191.0	191.0	184.0	184.0	179.0	179.0	75
80		184.0 <sup>(11)</sup>	188.0	188.0	183.0	183.0	178.0	178.0	172.0	172.0	167.0	167.0	80
85		166.0 <sup>(11)</sup>	174.0	174.0	171.0	171.0	167.0	167.0 <sup>(5)</sup>	161.0	161.0	156.0	156.0 <sup>(3)</sup>	85
90		151.0 <sup>(11)</sup>	161.0	161.0	159.0	159.0	157.0	157.0	152.0	152.0	147.0	147.0	90
95		138.0 <sup>(11)</sup>	148.0*	148.0	148.0	148.0	146.0	146.0	143.0	143.0	139.0	139.0	95
100		126.0 <sup>(11)</sup>		135.0 <sup>(11)</sup>	138.0	138.0	137.0	137.0	134.0	134.0	131.0	131.0	100
105		117.0 <sup>(11)</sup>		123.0 <sup>(11)</sup>	130.0	130.0 <sup>(11)</sup>	128.0	128.0	126.0	126.0	123.0	123.0	105
110		107.0 <sup>(11)</sup>		114.0 <sup>(11)</sup>	122.0	122.0	120.0	120.0	118.0	118.0	116.0	116.0	110
115		97.5 <sup>(11)</sup>		105.0 <sup>(11)</sup>	113.0*	113.0	114.0	114.0	111.0	111.0 <sup>(7)</sup>	109.0	109.0	115
120		89.3 <sup>(9)</sup>		97.1 <sup>(11)</sup>		103.0 <sup>(11)</sup>	107.0	107.0 <sup>(10)</sup>	105.0	105.0	103.0	103.0	120
125		82.7 <sup>(9)</sup>		90.2 <sup>(11)</sup>		94.9 <sup>(11)</sup>	101.0	101.0 <sup>(11)</sup>	99.2	99.2	97.1	97.1	125
130		76.0 <sup>(9)</sup>		83.2 <sup>(11)</sup>		88.2 <sup>(11)</sup>	96.3	96.3	94.0	94.0	91.9	91.9	130
135		69.4 <sup>(9)</sup>		76.2 <sup>(11)</sup>		81.4 <sup>(11)</sup>	89.4*	89.4	89.2	89.2	87.2	87.2	135
140		64.2 <sup>(7)</sup>		70.1 <sup>(9)</sup>		75.9 <sup>(11)</sup>		81.1 <sup>(11)</sup>	84.9	84.9	82.7	82.7	140
145		59.2 <sup>(7)</sup>		65.0 <sup>(9)</sup>		70.6 <sup>(11)</sup>		75.4 <sup>(11)</sup>	80.8	80.8	78.7	78.7	145
150		54.3 <sup>(7)</sup>		59.9 <sup>(9)</sup>		65.2 <sup>(11)</sup>		70.2 <sup>(11)</sup>	77.1	77.1	74.9	74.9	150
155				54.8 <sup>(9)</sup>		59.9 <sup>(11)</sup>		65.0 <sup>(11)</sup>	71.8*	71.8	71.5	71.5	155
160				50.6 <sup>(7)</sup>		54.9 <sup>(9)</sup>		60.8 <sup>(11)</sup>		64.3 <sup>(11)</sup>	68.3	68.3	160
165				46.6 <sup>(7)</sup>		50.9 <sup>(9)</sup>		56.5 <sup>(11)</sup>		60.0 <sup>(11)</sup>	65.3	65.3	165
170				42.7 <sup>(7)</sup>		46.8 <sup>(9)</sup>		52.2 <sup>(11)</sup>		55.8 <sup>(11)</sup>	62.5	62.5	170
175						42.4 <sup>(7)</sup>		47.9 <sup>(11)</sup>		51.8 <sup>(11)</sup>	58.2*	58.2	175
180						39.2 <sup>(7)</sup>		43.7 <sup>(9)</sup>		48.3 <sup>(11)</sup>		51.4 <sup>(11)</sup>	180
185						36.0 <sup>(7)</sup>		40.4 <sup>(9)</sup>		44.8 <sup>(11)</sup>		48.0 <sup>(11)</sup>	185
190						32.8 <sup>(7)</sup>		37.0 <sup>(9)</sup>		41.3 <sup>(11)</sup>		44.6 <sup>(11)</sup>	190
195								33.2 <sup>(7)</sup>		37.7 <sup>(11)</sup>		41.3 <sup>(11)</sup>	195
200								30.5 <sup>(7)</sup>		34.0 <sup>(9)</sup>		38.4 <sup>(11)</sup>	200
205								27.8 <sup>(7)</sup>		31.2 <sup>(9)</sup>		35.4 <sup>(11)</sup>	205
210								25.1 <sup>(7)</sup>		28.4 <sup>(9)</sup>		32.4 <sup>(11)</sup>	210
215										25.1 <sup>(7)</sup>		29.5 <sup>(11)</sup>	215
220										23.0 <sup>(7)</sup>		26.3 <sup>(9)</sup>	220
225										20.9 <sup>(7)</sup>		24.0 <sup>(9)</sup>	225
230										18.8 <sup>(7)</sup>		21.7 <sup>(9)</sup>	230
235												18.8 <sup>(7)</sup>	235
240												17.0 <sup>(7)</sup>	240
245												15.1 <sup>(7)</sup>	245

1) 12°; 2) 17°; 3) 22°; 4) 27°; 5) 32°; 6) 37°; 7) 42°; 8) 47°; 9) 52°; 10) 57°; 11) 62°

# Lifting capacities Forces de levage

SW



ft	S 118												ft
	W 177		W 197		W 217		W 236		W 256		W 276		
	87/85*	Wmax	87/85*	Wmax	87/85*	Wmax	87/85*	Wmax	87/85*	Wmax	87/85*	Wmax	
65	201.0	201.0 <sup>(1)</sup>											65
70	186.0	186.0	181.0	181.0 <sup>(1)</sup>	142.0								70
75	173.0	173.0	169.0	169.0	164.0	164.0 <sup>(1)</sup>	159.0						75
80	162.0	162.0	158.0	158.0	153.0	153.0	149.0	149.0 <sup>(1)</sup>	138.0				80
85	152.0	152.0	148.0	148.0 <sup>(2)</sup>	144.0	144.0	140.0	140.0	135.0	135.0	116.0		85
90	143.0	143.0	139.0	139.0	135.0	135.0	131.0	131.0	128.0	128.0	115.0	115.0	90
95	134.0	134.0 <sup>(3)</sup>	131.0	131.0	127.0	127.0 <sup>(2)</sup>	124.0	124.0	120.0	120.0	113.0	113.0	95
100	127.0	127.0	124.0	124.0	120.0	120.0	117.0	117.0	113.0	113.0	110.0	110.0	100
105	120.0	120.0	117.0	117.0	114.0	114.0	110.0	110.0	107.0	107.0 <sup>(2)</sup>	104.0	104.0	105
110	114.0	114.0	111.0	111.0	108.0	108.0 <sup>(3)</sup>	105.0	105.0	101.0	101.0	98.1	98.1	110
115	107.0	107.0	105.0	105.0	102.0	102.0	99.1	99.1	96.1	96.1	93.0	93.0	115
120	101.0	101.0 <sup>(3)</sup>	99.5	99.5	97.1	97.1	94.1	94.1	91.2	91.2	88.2	88.2	120
125	95.2	95.2	93.9	93.9	91.9	91.9	89.5	89.5	86.8	86.8	83.8	83.8	125
130	90.0	90.0	88.7	88.7 <sup>(6)</sup>	86.9	86.9	85.0	85.0	82.4	82.4	79.6	79.6	130
135	85.2	85.2	84.0	84.0	82.2	82.2	80.3	80.3	78.3	78.3	75.8	75.8	135
140	80.8	80.8	79.6	79.6	77.8	77.8	76.0	76.0	74.3	74.3	72.0	72.0	140
145	76.8	76.8	75.6	75.6	73.8	73.8	72.0	72.0	70.2	70.2	68.3	68.3	145
150	73.1	73.1	71.8	71.8	70.0	70.0	68.3	68.3	66.6	66.6	64.7	64.7	150
155	69.6	69.6	68.4	68.4	66.6	66.6	64.8	64.8	63.1	63.1	61.2	61.2 <sup>(4)</sup>	155
160	66.3	66.3	65.1	65.1	63.3	63.3	61.6	61.6	59.9	59.9	58.1	58.1	160
165	63.3	63.3	62.1	62.1	60.3	60.3	58.6	58.6	56.9	56.9	55.1	55.1	165
170	60.5	60.5	59.2	59.2	57.5	57.5	55.8	55.8	54.1	54.1	52.3	52.3	170
175	57.8	57.8	56.6	56.6	54.8	54.8	53.1	53.1	51.4	51.4	49.7	49.7	175
180	55.4	55.4	54.1	54.1	52.3	52.3	50.6	50.6	49.0	49.0	47.2	47.2	180
185	53.1	53.1	51.8	51.8	50.0	50.0	48.3	48.3	46.7	46.7	44.9	44.9	185
190	51.0	51.0	49.6	49.6	47.8	47.8	46.1	46.1	44.5	44.5	42.7	42.7	190
195	47.4*	47.4	47.5	47.5	45.7	45.7	44.0	44.0	42.4	42.4	40.6	40.6	195
200		41.1 <sup>(11)</sup>	45.6	45.6	43.7	43.7	42.1	42.1	40.4	40.4	38.7	38.7	200
205		38.2 <sup>(11)</sup>	43.8	43.8	41.8	41.8	40.2	40.2	38.5	38.5	36.8	36.8	205
210		35.3 <sup>(11)</sup>	42.2	42.2	40.1	40.1	38.4	38.4 <sup>(9)</sup>	36.8	36.8	35.1	35.1	210
215		32.7 <sup>(11)</sup>		35.8 <sup>(11)</sup>	38.4	38.4	36.8	36.8	35.1	35.1	33.4	33.4	215
220		30.1 <sup>(11)</sup>		33.2 <sup>(11)</sup>	36.9	36.9	35.2	35.2	33.5	33.5	31.8	31.8	220
225		27.5 <sup>(11)</sup>		30.7 <sup>(11)</sup>	35.4	35.4	33.7	33.7	32.0	32.0	30.3	30.3	225
230		25.0 <sup>(11)</sup>		28.2 <sup>(11)</sup>	34.2	34.2	32.3	32.3	30.5	30.5	28.9	28.9	230
235		22.5 <sup>(11)</sup>		26.1 <sup>(11)</sup>		28.0 <sup>(11)</sup>	31.0	31.0	29.2	29.2	27.5	27.5	235
240		19.9 <sup>(9)</sup>		24.0 <sup>(11)</sup>		25.9 <sup>(11)</sup>	29.7	29.7	27.9	27.9	26.2	26.2	240
245		18.1 <sup>(9)</sup>		22.0 <sup>(11)</sup>		23.8 <sup>(11)</sup>	28.5	28.5	26.6	26.6	24.9	24.9	245
250		16.3 <sup>(9)</sup>		19.9 <sup>(11)</sup>		21.7 <sup>(11)</sup>	27.6	27.6	25.4	25.4	23.8	23.8	250
255		13.6 <sup>(7)</sup>		17.8 <sup>(11)</sup>		20.0 <sup>(11)</sup>		21.7 <sup>(11)</sup>	24.3	24.3	22.6	22.6 <sup>(10)</sup>	255
260		11.8 <sup>(7)</sup>		15.3 <sup>(9)</sup>		18.3 <sup>(11)</sup>		20.1 <sup>(11)</sup>	23.3	23.3	21.6	21.6	260
265		10.0 <sup>(7)</sup>		13.6 <sup>(9)</sup>		16.6 <sup>(11)</sup>		18.5 <sup>(11)</sup>	22.3	22.3	20.8	20.8	265
270				12.0 <sup>(9)</sup>		14.9 <sup>(11)</sup>		16.9 <sup>(11)</sup>	20.4*	20.4	20.0	20.0	270
275				9.4 <sup>(7)</sup>		12.2 <sup>(9)</sup>		15.4 <sup>(11)</sup>		16.8 <sup>(11)</sup>	19.2	19.2	275
280				7.7 <sup>(7)</sup>		10.6 <sup>(9)</sup>		13.9 <sup>(11)</sup>		15.3 <sup>(11)</sup>	18.4	18.4	280
285						8.9 <sup>(9)</sup>		12.3 <sup>(11)</sup>		13.9 <sup>(11)</sup>	17.8	17.8	285
290						7.3 <sup>(9)</sup>		10.8 <sup>(11)</sup>		12.5 <sup>(11)</sup>	16.1*	16.1	290
295										11.0 <sup>(11)</sup>		12.5 <sup>(11)</sup>	295
300										9.4 <sup>(11)</sup>		11.2 <sup>(11)</sup>	300
305										7.9 <sup>(11)</sup>		10.0 <sup>(11)</sup>	305
310										6.4 <sup>(11)</sup>		5.4 <sup>(8)</sup>	310

1) 12°; 2) 17°; 3) 22°; 4) 27°; 5) 32°; 6) 37°; 7) 42°; 8) 47°; 9) 52°; 10) 57°; 11) 62°

# Lifting capacities Forces de levage

SW

98-217 ft	59-276 ft	88,200 lbs	374,800 lbs
			330,700 lbs
			286,600 lbs

		60
--	--	----

ft	S 138												ft
	W 59		W 79		W 98		W 118		W 138		W 157		
	87/85*	Wmax	87/85*	Wmax	87/85*	Wmax	87/85*	Wmax	87/85*	Wmax	87/85*	Wmax	
34	454.0	454.0 <sup>(1)</sup>											34
36	429.0	430.0 <sup>(1)</sup>											36
38	407.0	407.0	390.0										38
40	387.0	387.0 <sup>(2)</sup>	371.0	371.0 <sup>(1)</sup>									40
45	344.0	344.0 <sup>(3)</sup>	331.0	331.0	318.0	318.0 <sup>(1)</sup>							45
50	310.0	310.0	298.0	298.0	287.0	287.0	278.0	278.0 <sup>(1)</sup>					50
55	281.0	281.0	271.0	271.0	261.0	261.0	253.0	253.0	245.0	245.0			55
60	258.0	258.0	248.0	248.0	239.0	239.0 <sup>(3)</sup>	232.0	232.0 <sup>(2)</sup>	224.0	224.0	217.0	217.0 <sup>(1)</sup>	60
65	238.0	238.0	229.0	229.0	221.0	221.0	214.0	214.0	207.0	207.0	201.0	201.0	65
70	221.0	221.0	212.0	212.0 <sup>(6)</sup>	205.0	205.0	199.0	199.0	192.0	192.0	186.0	186.0	70
75	200.0*	200.0 <sup>(11)</sup>	198.0	198.0	191.0	191.0	185.0	185.0	179.0	179.0	174.0	174.0	75
80		183.0 <sup>(11)</sup>	185.0	185.0	178.0	178.0	173.0	173.0	168.0	168.0	162.0	162.0	80
85		165.0 <sup>(11)</sup>	172.0	172.0 <sup>(10)</sup>	167.0	167.0	162.0	162.0	157.0	157.0	152.0	152.0 <sup>(9)</sup>	85
90		149.0 <sup>(11)</sup>	160.0	160.0	157.0	157.0	153.0	153.0	148.0	148.0	143.0	143.0	90
95		137.0 <sup>(11)</sup>	146.0*	146.0	146.0	146.0 <sup>(8)</sup>	144.0	144.0 <sup>(6)</sup>	139.0	139.0	135.0	135.0	95
100		124.0 <sup>(11)</sup>		134.0 <sup>(11)</sup>	137.0	137.0	135.0	135.0	132.0	132.0	128.0	128.0	100
105		114.0 <sup>(11)</sup>		123.0 <sup>(11)</sup>	128.0	128.0	127.0	127.0	125.0	125.0	121.0	121.0	105
110		106.0 <sup>(11)</sup>		112.0 <sup>(11)</sup>	121.0	121.0	119.0	119.0 <sup>(8)</sup>	117.0	117.0	115.0	115.0	110
115		97.3 <sup>(11)</sup>		104.0 <sup>(11)</sup>	111.0*	111.0	112.0	112.0 <sup>(9)</sup>	110.0	110.0 <sup>(7)</sup>	108.0	108.0	115
120		88.8 <sup>(11)</sup>		95.2 <sup>(11)</sup>		102.0 <sup>(11)</sup>	106.0	106.0 <sup>(10)</sup>	104.0	104.0	102.0	102.0 <sup>(6)</sup>	120
125		80.3 <sup>(11)</sup>		88.3 <sup>(11)</sup>		93.9 <sup>(11)</sup>	101.0	101.0	98.3	98.3	96.3	96.3	125
130		74.2 <sup>(9)</sup>		82.0 <sup>(11)</sup>		86.9 <sup>(11)</sup>	95.3	95.3	93.2	93.2 <sup>(9)</sup>	91.1	91.1	130
135		68.6 <sup>(9)</sup>		75.7 <sup>(11)</sup>		80.5 <sup>(11)</sup>	88.0*	88.0	88.4	88.4	86.4	86.4	135
140		62.9 <sup>(9)</sup>		69.4 <sup>(11)</sup>		74.2 <sup>(11)</sup>		80.4 <sup>(11)</sup>	84.0	84.0	82.0	82.0	140
145		57.3 <sup>(6)</sup>		63.2 <sup>(11)</sup>		69.1 <sup>(11)</sup>		74.3 <sup>(11)</sup>	80.0	80.0	78.0	78.0	145
150		52.6 <sup>(7)</sup>		58.3 <sup>(9)</sup>		64.2 <sup>(11)</sup>		69.2 <sup>(11)</sup>	76.3	76.3	74.2	74.2	150
155		48.4 <sup>(7)</sup>		53.9 <sup>(9)</sup>		59.3 <sup>(11)</sup>		64.2 <sup>(11)</sup>	70.6*	70.6	70.8	70.8	155
160		44.3 <sup>(7)</sup>		49.5 <sup>(9)</sup>		54.4 <sup>(11)</sup>		59.3 <sup>(11)</sup>		63.7 <sup>(11)</sup>	67.5	67.5	160
165		40.1 <sup>(6)</sup>		45.0 <sup>(9)</sup>		49.5 <sup>(11)</sup>		55.3 <sup>(11)</sup>		59.0 <sup>(11)</sup>	64.6	64.6	165
170				41.1 <sup>(7)</sup>		45.4 <sup>(9)</sup>		51.3 <sup>(11)</sup>		55.0 <sup>(11)</sup>	61.8	61.8	170
175				37.7 <sup>(7)</sup>		41.8 <sup>(9)</sup>		47.3 <sup>(11)</sup>		50.9 <sup>(11)</sup>	57.1*	57.1	175
180				34.4 <sup>(7)</sup>		38.2 <sup>(9)</sup>		43.3 <sup>(11)</sup>		47.0 <sup>(11)</sup>		50.8 <sup>(11)</sup>	180
185				31.0 <sup>(7)</sup>		34.6 <sup>(9)</sup>		38.8 <sup>(9)</sup>		43.7 <sup>(11)</sup>		47.1 <sup>(11)</sup>	185
190						31.2 <sup>(7)</sup>		35.7 <sup>(9)</sup>		40.4 <sup>(11)</sup>		43.8 <sup>(11)</sup>	190
195						28.4 <sup>(7)</sup>		32.7 <sup>(9)</sup>		37.0 <sup>(11)</sup>		40.4 <sup>(11)</sup>	195
200						25.6 <sup>(7)</sup>		29.7 <sup>(9)</sup>		33.7 <sup>(11)</sup>		37.3 <sup>(11)</sup>	200
205								26.7 <sup>(9)</sup>		29.8 <sup>(9)</sup>		34.4 <sup>(11)</sup>	205
210								23.9 <sup>(7)</sup>		27.3 <sup>(9)</sup>		31.6 <sup>(11)</sup>	210
215								21.7 <sup>(7)</sup>		24.9 <sup>(9)</sup>		28.8 <sup>(11)</sup>	215
220								19.5 <sup>(7)</sup>		22.4 <sup>(9)</sup>		25.9 <sup>(11)</sup>	220
225										19.9 <sup>(9)</sup>		22.6 <sup>(9)</sup>	225
230										17.3 <sup>(7)</sup>		20.6 <sup>(9)</sup>	230
235										15.3 <sup>(7)</sup>		18.7 <sup>(9)</sup>	235
240										13.4 <sup>(7)</sup>		16.7 <sup>(9)</sup>	240
245												14.8 <sup>(9)</sup>	245
250												12.1 <sup>(7)</sup>	250
255												10.2 <sup>(7)</sup>	255
260												8.3 <sup>(7)</sup>	260

1) 12°; 2) 17°; 3) 22°; 4) 27°; 5) 32°; 6) 37°; 7) 42°; 8) 47°; 9) 52°; 10) 57°; 11) 62°

# Lifting capacities Forces de levage

SW

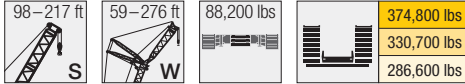
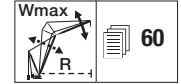







ft	S 138												ft
	W 177		W 197		W 217		W 236		W 256		W 276		
	87/85*	Wmax	87/85*	Wmax	87/85*	Wmax	87/85*	Wmax	87/85*	Wmax	87/85*	Wmax	
65	195.0	195.0 <sup>(1)</sup>											65
70	181.0	181.0	176.0	176.0 <sup>(1)</sup>									70
75	169.0	169.0	164.0	164.0	159.0	159.0 <sup>(1)</sup>							75
80	158.0	158.0	154.0	154.0	149.0	149.0	143.0	143.0 <sup>(1)</sup>					80
85	148.0	148.0	144.0	144.0	139.0	139.0	135.0	135.0	125.0	125.0			85
90	139.0	139.0	136.0	136.0	131.0	131.0	127.0	127.0	122.0	122.0	107.0	107.0 <sup>(1)</sup>	90
95	131.0	131.0 <sup>(3)</sup>	128.0	128.0	123.0	123.0 <sup>(2)</sup>	120.0	120.0	116.0	116.0	105.0	105.0	95
100	124.0	124.0	121.0	121.0	116.0	116.0	113.0	113.0 <sup>(2)</sup>	110.0	110.0	103.0	103.0	100
105	117.0	117.0	114.0	114.0 <sup>(3)</sup>	110.0	110.0	107.0	107.0	104.0	104.0	100.0	100.0	105
110	111.0	111.0	109.0	109.0	104.0	104.0 <sup>(3)</sup>	101.0	101.0	98.3	98.3	94.9	94.9	110
115	106.0	106.0	103.0	103.0	99.1	99.1	95.9	95.9	93.1	93.1	90.0	90.0	115
120	100.0	100.0	98.1	98.1	94.1	94.1	91.2	91.2	88.4	88.4	85.3	85.3	120
125	94.4	94.4	93.1	93.1	89.6	89.6	86.7	86.7	84.0	84.0	81.1	81.1	125
130	89.3	89.3	88.0	88.0	85.2	85.2	82.5	82.5	79.8	79.8	77.0	77.0	130
135	84.5	84.5	83.3	83.3	80.9	80.9	78.6	78.6	76.1	76.1	73.3	73.3 <sup>(3)</sup>	135
140	80.2	80.2	79.0	79.0	76.5	76.5	74.7	74.7	72.4	72.4	69.7	69.7	140
145	76.1	76.1	75.0	75.0	72.5	72.5	70.8	70.8	68.9	68.9	66.5	66.5	145
150	72.4	72.4	71.3	71.3	68.9	68.9	67.0	67.0	65.4	65.4	63.3	63.3	150
155	69.0	69.0	67.8	67.8	65.5	65.5	63.7	63.7	61.9	61.9	60.0	60.0	155
160	65.7	65.7	64.6	64.6	62.2	62.2	60.5	60.5	58.8	58.8	56.9	56.9	160
165	62.7	62.7	61.6	61.6	59.3	59.3	57.5	57.5	55.8	55.8 <sup>(9)</sup>	53.9	53.9	165
170	59.9	59.9	58.8	58.8	56.4	56.4	54.7	54.7	53.0	53.0	51.2	51.2	170
175	57.2	57.2	56.1	56.1	53.8	53.8	52.1	52.1	50.4	50.4	48.6	48.6	175
180	54.8	54.8	53.6	53.6	51.3	51.3	49.6	49.6	48.0	48.0	46.2	46.2	180
185	52.5	52.5	51.3	51.3	49.0	49.0	47.3	47.3 <sup>(7)</sup>	45.7	45.7	43.9	43.9	185
190	50.3	50.3	49.1	49.1	46.8	46.8	45.1	45.1	43.5	43.5	41.7	41.7	190
195	46.4*	46.4	47.0	47.0 <sup>(11)</sup>	44.8	44.8	43.1	43.1	41.4	41.4	39.7	39.7 <sup>(6)</sup>	195
200		40.5 <sup>(11)</sup>	45.1	45.1	42.8	42.8	41.1	41.1	39.5	39.5	37.7	37.7	200
205		37.5 <sup>(11)</sup>	43.3	43.3	41.0	41.0	39.3	39.3	37.7	37.7	35.9	35.9	205
210		34.6 <sup>(11)</sup>	41.6	41.6	39.2	39.2	37.5	37.5	35.9	35.9	34.2	34.2	210
215		31.8 <sup>(11)</sup>	38.2*	38.2	37.6	37.6	35.9	35.9	34.2	34.2	32.5	32.5	215
220		29.2 <sup>(11)</sup>		32.5 <sup>(11)</sup>	36.0	36.0	34.3	34.3	32.6	32.6	30.9	30.9	220
225		26.9 <sup>(11)</sup>		30.0 <sup>(11)</sup>	34.6	34.6	32.8	32.8	31.2	31.2	29.4	29.4	225
230		24.6 <sup>(11)</sup>		27.6 <sup>(11)</sup>	33.3	33.3	31.4	31.4	29.7	29.7	28.0	28.0	230
235		22.2 <sup>(11)</sup>		25.1 <sup>(11)</sup>	30.3*	30.3	30.1	30.1	28.4	28.4	26.7	26.7	235
240		19.9 <sup>(11)</sup>		23.1 <sup>(11)</sup>		24.8 <sup>(11)</sup>	28.9	28.9	27.1	27.1	25.4	25.4	240
245		16.9 <sup>(9)</sup>		21.2 <sup>(11)</sup>		22.9 <sup>(11)</sup>	27.7	27.7	25.8	25.8	24.1	24.1	245
250		15.1 <sup>(9)</sup>		19.3 <sup>(11)</sup>		20.9 <sup>(11)</sup>	26.7	26.7	24.7	24.7	23.0	23.0	250
255		13.3 <sup>(9)</sup>		17.4 <sup>(11)</sup>		19.0 <sup>(11)</sup>	24.1*	24.1	23.6	23.6	21.9	21.9	255
260		11.5 <sup>(9)</sup>		15.4 <sup>(11)</sup>		17.3 <sup>(11)</sup>		19.2 <sup>(11)</sup>	22.5	22.5	21.0	21.0	260
265				12.7 <sup>(9)</sup>		15.7 <sup>(11)</sup>		17.6 <sup>(11)</sup>	21.7	21.7	20.1	20.1	265
270				11.0 <sup>(9)</sup>		14.0 <sup>(11)</sup>		16.0 <sup>(11)</sup>	21.0	21.0	19.3	19.3	270
275				9.3 <sup>(9)</sup>		12.4 <sup>(11)</sup>		14.4 <sup>(11)</sup>	18.9*	18.9	18.5	18.5	275
280				7.6 <sup>(9)</sup>		10.7 <sup>(11)</sup>		12.9 <sup>(11)</sup>		14.5 <sup>(11)</sup>	17.8	17.8	280
285								11.3 <sup>(11)</sup>		13.1 <sup>(11)</sup>	17.2	17.2	285
290								9.7 <sup>(11)</sup>		11.7 <sup>(11)</sup>	16.6	16.6	290
295								8.2 <sup>(11)</sup>		6.7 <sup>(9)</sup>	14.8*	14.8	295
300								6.6 <sup>(11)</sup>				10.3 <sup>(11)</sup>	300
305												9.0 <sup>(11)</sup>	305
310												7.7 <sup>(11)</sup>	310

1) 12°; 2) 17°; 3) 22°; 4) 27°; 5) 32°; 6) 37°; 7) 42°; 8) 47°; 9) 52°; 10) 57°; 11) 62°

# Lifting capacities Forces de levage

SW

98-217 ft	59-276 ft	88,200 lbs	374,800 lbs
			
			330,700 lbs
			286,600 lbs

		60
---	---	----

ft	S 157												ft
	W 59		W 79		W 98		W 118		W 138		W 157		
	87/85*	Wmax	87/85*	Wmax	87/85*	Wmax	87/85*	Wmax	87/85*	Wmax	87/85*	Wmax	
34	432.0												34
36	409.0	409.0 <sup>(1)</sup>											36
38	388.0	388.0											38
40	370.0	370.0	356.0	356.0 <sup>(1)</sup>									40
45	330.0	330.0 <sup>(3)</sup>	318.0	318.0	306.0								45
50	297.0	297.0 <sup>(4)</sup>	287.0	287.0	276.0	276.0	268.0						50
55	271.0	271.0	262.0	262.0	252.0	252.0 <sup>(2)</sup>	245.0	245.0	193.0				55
60	248.0	248.0	240.0	240.0	232.0	232.0	225.0	225.0 <sup>(2)</sup>	217.0	217.0			60
65	229.0	229.0	222.0	222.0	214.0	214.0	208.0	208.0	201.0	201.0	195.0	195.0	65
70	213.0	213.0	206.0	206.0 <sup>(6)</sup>	198.0	198.0 <sup>(4)</sup>	193.0	193.0 <sup>(3)</sup>	187.0	187.0	181.0	181.0	70
75	201.0	201.0	192.0	192.0 <sup>(7)</sup>	185.0	185.0	180.0	180.0	174.0	174.0	169.0	169.0	75
80	180.0*	180.0	180.0	180.0	173.0	173.0	168.0	168.0 <sup>(4)</sup>	163.0	163.0	158.0	158.0	80
85		163.0 <sup>(11)</sup>	169.0	169.0	163.0	163.0	158.0	158.0	153.0	153.0	148.0	148.0	85
90		148.0 <sup>(11)</sup>	158.0	158.0 <sup>(11)</sup>	153.0	153.0	149.0	149.0	144.0	144.0	140.0	140.0	90
95		134.0 <sup>(11)</sup>	143.0*	144.0 <sup>(11)</sup>	145.0	145.0	141.0	141.0	136.0	136.0	132.0	132.0	95
100		123.0 <sup>(11)</sup>	134.0*	134.0	135.0	135.0 <sup>(9)</sup>	133.0	133.0	128.0	128.0 <sup>(5)</sup>	125.0	125.0	100
105		112.0 <sup>(11)</sup>		122.0 <sup>(11)</sup>	127.0	127.0	126.0	126.0	122.0	122.0	118.0	118.0	105
110		103.0 <sup>(11)</sup>		111.0 <sup>(11)</sup>	119.0	119.0	118.0	118.0 <sup>(8)</sup>	116.0	116.0	112.0	112.0 <sup>(5)</sup>	110
115		95.2 <sup>(11)</sup>		102.0 <sup>(11)</sup>	109.0*	109.0 <sup>(11)</sup>	111.0	111.0 <sup>(9)</sup>	109.0	109.0	106.0	106.0	115
120		87.7 <sup>(11)</sup>		94.4 <sup>(11)</sup>		101.0 <sup>(11)</sup>	105.0	105.0	103.0	103.0	101.0	101.0	120
125		80.3 <sup>(11)</sup>		86.4 <sup>(11)</sup>		93.3 <sup>(11)</sup>	99.4	99.4	97.4	97.4	95.4	95.4	125
130		72.8 <sup>(11)</sup>		80.1 <sup>(11)</sup>		85.4 <sup>(11)</sup>	94.3	94.3	92.2	92.2	90.3	90.3 <sup>(7)</sup>	130
135		65.8 <sup>(9)</sup>		74.4 <sup>(11)</sup>		79.4 <sup>(11)</sup>	86.6*	86.6	87.5	87.5	85.5	85.5	135
140		60.9 <sup>(9)</sup>		68.7 <sup>(11)</sup>		73.4 <sup>(11)</sup>		79.7 <sup>(11)</sup>	83.1	83.1	81.2	81.2	140
145		56.0 <sup>(9)</sup>		63.0 <sup>(11)</sup>		67.3 <sup>(11)</sup>		73.7 <sup>(11)</sup>	79.1	79.1	77.2	77.2	145
150		51.2 <sup>(9)</sup>		57.4 <sup>(11)</sup>		62.6 <sup>(11)</sup>		68.0 <sup>(11)</sup>	75.4	75.4	73.5	73.5	150
155		46.3 <sup>(9)</sup>		51.9 <sup>(9)</sup>		58.1 <sup>(11)</sup>		63.3 <sup>(11)</sup>	69.3*	69.3	70.0	70.0	155
160		42.0 <sup>(7)</sup>		48.0 <sup>(9)</sup>		53.6 <sup>(11)</sup>		58.5 <sup>(11)</sup>		63.1 <sup>(11)</sup>	66.8	66.8	160
165		38.5 <sup>(7)</sup>		44.1 <sup>(9)</sup>		49.1 <sup>(11)</sup>		53.8 <sup>(11)</sup>		58.3 <sup>(11)</sup>	63.8	63.8	165
170		35.0 <sup>(7)</sup>		40.2 <sup>(9)</sup>		44.6 <sup>(11)</sup>		50.0 <sup>(11)</sup>		54.0 <sup>(11)</sup>	61.1	61.1	170
175		31.5 <sup>(7)</sup>		36.3 <sup>(9)</sup>		40.1 <sup>(9)</sup>		46.3 <sup>(11)</sup>		50.1 <sup>(11)</sup>	56.1*	56.1	175
180				32.6 <sup>(7)</sup>		36.8 <sup>(9)</sup>		42.6 <sup>(11)</sup>		46.2 <sup>(11)</sup>		50.3 <sup>(11)</sup>	180
185				29.7 <sup>(7)</sup>		33.6 <sup>(9)</sup>		38.9 <sup>(11)</sup>		42.4 <sup>(11)</sup>		46.4 <sup>(11)</sup>	185
190				26.8 <sup>(7)</sup>		30.4 <sup>(9)</sup>		35.2 <sup>(11)</sup>		39.3 <sup>(11)</sup>		43.0 <sup>(11)</sup>	190
195				23.9 <sup>(7)</sup>		27.1 <sup>(9)</sup>		31.3 <sup>(9)</sup>		36.2 <sup>(11)</sup>		39.7 <sup>(11)</sup>	195
200						24.0 <sup>(7)</sup>		28.7 <sup>(9)</sup>		33.0 <sup>(11)</sup>		36.4 <sup>(11)</sup>	200
205						21.8 <sup>(7)</sup>		26.0 <sup>(9)</sup>		29.9 <sup>(11)</sup>		33.4 <sup>(11)</sup>	205
210						19.5 <sup>(7)</sup>		23.3 <sup>(9)</sup>		26.7 <sup>(11)</sup>		30.8 <sup>(11)</sup>	210
215						17.2 <sup>(7)</sup>		20.7 <sup>(9)</sup>		23.5 <sup>(9)</sup>		28.2 <sup>(11)</sup>	215
220								17.9 <sup>(7)</sup>		21.4 <sup>(9)</sup>		25.6 <sup>(11)</sup>	220
225								15.8 <sup>(7)</sup>		19.3 <sup>(9)</sup>		23.0 <sup>(11)</sup>	225
230								13.8 <sup>(7)</sup>		17.2 <sup>(9)</sup>		20.4 <sup>(11)</sup>	230
235								11.8 <sup>(7)</sup>		15.1 <sup>(9)</sup>		17.4 <sup>(9)</sup>	235
240										12.4 <sup>(7)</sup>		15.6 <sup>(9)</sup>	240
245										10.4 <sup>(7)</sup>		13.7 <sup>(9)</sup>	245
250										8.4 <sup>(7)</sup>		11.8 <sup>(9)</sup>	250
255										6.5 <sup>(7)</sup>		9.9 <sup>(9)</sup>	255

1) 12°; 2) 17°; 3) 22°; 4) 27°; 5) 32°; 6) 37°; 7) 42°; 8) 47°; 9) 52°; 10) 57°; 11) 62°



# Lifting capacities Forces de levage

SW







ft	S 157												ft
	W 177		W 197		W 217		W 236		W 256		W 276		
	87/85*	Wmax	87/85*	Wmax	87/85*	Wmax	87/85*	Wmax	87/85*	Wmax	87/85*	Wmax	
70	175.0	175.0											70
75	163.0	163.0	159.0	159.0									75
80	152.0	152.0	149.0	149.0	144.0	144.0	136.0						80
85	143.0	143.0	140.0	140.0	135.0	135.0	131.0	131.0	118.0				85
90	135.0	135.0	132.0	132.0	127.0	127.0	123.0	123.0	116.0	116.0	102.0		90
95	127.0	127.0 <sup>3)</sup>	124.0	124.0	119.0	119.0 <sup>2)</sup>	116.0	116.0	112.0	112.0	100.0	100.0	95
100	120.0	120.0	117.0	117.0	113.0	113.0	109.0	109.0	106.0	106.0	98.6	98.6	100
105	114.0	114.0	111.0	111.0	107.0	107.0	103.0	103.0	100.0	100.0	96.6	96.6	105
110	108.0	108.0	105.0	105.0	101.0	101.0	97.9	97.9	95.0	95.0	91.7	91.7	110
115	102.0	102.0	100.0	100.0	95.9	95.9	92.8	92.8	90.0	90.0	86.9	86.9	115
120	97.4	97.4	95.1	95.1	91.2	91.2	88.2	88.2	85.5	85.5	82.5	82.5	120
125	92.6	92.6	90.5	90.5	86.8	86.8	83.9	83.9	81.2	81.2	78.3	78.3	125
130	87.8	87.8	86.3	86.3	82.7	82.7	79.8	79.8	77.2	77.2	74.4	74.4	130
135	83.1	83.1	81.9	81.9	78.8	78.8	76.1	76.1	73.5	73.5	70.8	70.8	135
140	78.8	78.8	77.6	77.6	75.1	75.1	72.5	72.5	70.0	70.0	67.3	67.3	140
145	74.8	74.8	73.7	73.7	71.2	71.2	69.2	69.2	66.8	66.8	64.2	64.2	145
150	71.1	71.1	70.0	70.0	67.6	67.6	65.7	65.7	63.7	63.7	61.1	61.1	150
155	67.7	67.7	66.6	66.6	64.2	64.2	62.4	62.4	60.6	60.6	58.3	58.3	155
160	64.5	64.5	63.4	63.4	61.0	61.0	59.2	59.2	57.6	57.6	55.5	55.5	160
165	61.5	61.5	60.4	60.4	58.1	58.1	56.3	56.3	54.6	54.6	52.7	52.7	165
170	58.7	58.7	57.6	57.6	55.3	55.3	53.5	53.5	51.9	51.9	50.0	50.0	170
175	56.1	56.1	55.0	55.0	52.7	52.7	50.9	50.9	49.3	49.3	47.4	47.4	175
180	53.7	53.7	52.6	52.6	50.2	50.2	48.5	48.5	46.9	46.9	45.0	45.0	180
185	51.4	51.4	50.2	50.2	47.9	47.9	46.2	46.2	44.6	44.6	42.8	42.8	185
190	49.3	49.3	48.1	48.1	45.8	45.8	44.1	44.1	42.4	42.4	40.6	40.6	190
195	45.0*	45.0	46.0	46.0	43.7	43.7	42.0	42.0	40.4	40.4	38.6	38.6	195
200		39.5 <sup>1)</sup>	44.1	44.1	41.8	41.8	40.1	40.1	38.5	38.5	36.7	36.7	200
205		36.2 <sup>1)</sup>	42.3	42.3	40.0	40.0	38.3	38.3	36.7	36.7	34.9	34.9	205
210		33.5 <sup>1)</sup>	40.6	40.6	38.2	38.2	36.5	36.5	34.9	34.9	33.2	33.2	210
215		30.7 <sup>1)</sup>	36.9*	36.9	36.6	36.6	34.9	34.9	33.3	33.3	31.5	31.5	215
220		27.9 <sup>1)</sup>		31.6 <sup>1)</sup>	35.1	35.1	33.4	33.4	31.7	31.7	30.0	30.0	220
225		25.5 <sup>1)</sup>		28.9 <sup>1)</sup>	33.6	33.6	31.9	31.9	30.2	30.2	28.5	28.5	225
230		23.4 <sup>1)</sup>		26.6 <sup>1)</sup>	32.3	32.3	30.5	30.5	28.8	28.8	27.1	27.1	230
235		21.3 <sup>1)</sup>		24.2 <sup>1)</sup>	29.1*	29.1	29.2	29.2	27.5	27.5	25.8	25.8	235
240		19.1 <sup>1)</sup>		21.9 <sup>1)</sup>		23.8 <sup>1)</sup>	28.0	28.0	26.2	26.2	24.5	24.5	240
245		17.0 <sup>1)</sup>		19.9 <sup>1)</sup>		21.7 <sup>1)</sup>	26.8	26.8	25.0	25.0	23.3	23.3	245
250		14.9 <sup>1)</sup>		18.1 <sup>1)</sup>		19.9 <sup>1)</sup>	25.8	25.8	23.8	23.8 <sup>1)</sup>	22.2	22.2	250
255		12.1 <sup>9)</sup>		16.4 <sup>1)</sup>		18.1 <sup>1)</sup>	22.9*	22.9	22.7	22.7	21.2	21.2	255
260		10.3 <sup>9)</sup>		14.6 <sup>1)</sup>		16.3 <sup>1)</sup>		18.4 <sup>1)</sup>	21.8	21.8	20.3	20.3	260
265		8.5 <sup>9)</sup>		12.8 <sup>1)</sup>		14.6 <sup>1)</sup>		16.7 <sup>1)</sup>	21.0	21.0	19.4	19.4	265
270				11.0 <sup>1)</sup>		12.9 <sup>1)</sup>		15.1 <sup>1)</sup>	20.2	20.2	18.6	18.6	270
275						11.2 <sup>1)</sup>		13.6 <sup>1)</sup>	18.0*	18.0	17.9	17.9	275
280						9.5 <sup>1)</sup>		8.3 <sup>8)</sup>		13.7 <sup>1)</sup>	17.2	17.2	280
285						7.8 <sup>1)</sup>		6.8 <sup>8)</sup>		12.2 <sup>1)</sup>	16.5	16.5	285
290						6.1 <sup>1)</sup>				10.7 <sup>1)</sup>	15.9	15.9	290
295										9.3 <sup>1)</sup>	13.9*	13.9	295
300												9.5 <sup>1)</sup>	300
305												7.9 <sup>1)</sup>	305
310												6.3 <sup>1)</sup>	310

1) 12°; 2) 17°; 3) 22°; 4) 27°; 5) 32°; 6) 37°; 7) 42°; 8) 47°; 9) 52°; 10) 57°; 11) 62°

# Lifting capacities Forces de levage

SW

98-217 ft	59-276 ft	88,200 lbs	374,800 lbs
			
			330,700 lbs
			286,600 lbs

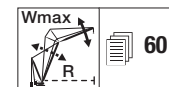

ft	S 177												ft
	W 59		W 79		W 98		W 118		W 138		W 157		
	87/85*	Wmax	87/85*	Wmax	87/85*	Wmax	87/85*	Wmax	87/85*	Wmax	87/85*	Wmax	
36	390.0	391.0 <sup>(1)</sup>											36
38	371.0	371.0 <sup>(1)</sup>											38
40	354.0	354.0	341.0										40
45	317.0	317.0	305.0	305.0	294.0								45
50	286.0	286.0 <sup>(4)</sup>	276.0	276.0	266.0	266.0							50
55	261.0	261.0 <sup>(6)</sup>	252.0	252.0 <sup>(3)</sup>	243.0	243.0 <sup>(2)</sup>	236.0	236.0					55
60	240.0	240.0	232.0	232.0 <sup>(4)</sup>	224.0	224.0	217.0	217.0	209.0	209.0			60
65	222.0	222.0 <sup>(6)</sup>	215.0	215.0	207.0	207.0	201.0	201.0	194.0	194.0	188.0	188.0	65
70	207.0	207.0	199.0	199.0	192.0	192.0 <sup>(4)</sup>	187.0	187.0	180.0	180.0	175.0	175.0	70
75	194.0	194.0	186.0	186.0	179.0	179.0	175.0	175.0	168.0	168.0	163.0	163.0 <sup>(2)</sup>	75
80	174.0*	174.0 <sup>(11)</sup>	174.0	174.0 <sup>(6)</sup>	168.0	168.0	163.0	163.0 <sup>(4)</sup>	157.0	157.0 <sup>(3)</sup>	153.0	153.0	80
85		160.0 <sup>(11)</sup>	164.0	164.0	158.0	158.0	154.0	154.0	148.0	148.0	143.0	143.0	85
90		146.0 <sup>(11)</sup>	155.0	155.0 <sup>(11)</sup>	149.0	149.0	145.0	145.0	139.0	139.0 <sup>(4)</sup>	135.0	135.0	90
95		132.0 <sup>(11)</sup>	146.0	146.0	141.0	141.0 <sup>(6)</sup>	137.0	137.0	131.0	131.0	127.0	127.0	95
100		122.0 <sup>(11)</sup>	132.0*	132.0	133.0	133.0 <sup>(9)</sup>	130.0	130.0	124.0	124.0 <sup>(5)</sup>	121.0	121.0	100
105		111.0 <sup>(11)</sup>		121.0 <sup>(11)</sup>	126.0	126.0	123.0	123.0	118.0	118.0	114.0	114.0	105
110		101.0 <sup>(11)</sup>		111.0 <sup>(11)</sup>	118.0	118.0	117.0	117.0 <sup>(6)</sup>	112.0	112.0	108.0	108.0	110
115		92.7 <sup>(11)</sup>		100.0 <sup>(11)</sup>	111.0	111.0	110.0	110.0	107.0	107.0	103.0	103.0	115
120		86.0 <sup>(11)</sup>		93.1 <sup>(11)</sup>	101.0*	101.0	104.0	104.0	101.0	101.0	98.2	98.2	120
125		79.3 <sup>(11)</sup>		85.6 <sup>(11)</sup>		92.5 <sup>(11)</sup>	98.5	98.5	95.9	95.9	93.7	93.7	125
130		72.6 <sup>(11)</sup>		78.2 <sup>(11)</sup>		85.0 <sup>(11)</sup>	93.3	93.3	90.8	90.8	88.8	88.8	130
135		65.9 <sup>(10)</sup>		72.3 <sup>(11)</sup>		78.0 <sup>(11)</sup>	88.5	88.5	86.1	86.1	84.2	84.2	135
140		59.3 <sup>(10)</sup>		67.1 <sup>(11)</sup>		72.3 <sup>(11)</sup>	81.0*	81.0	81.8	81.8	79.9	79.9	140
145		53.9 <sup>(9)</sup>		61.9 <sup>(11)</sup>		66.6 <sup>(11)</sup>		73.1 <sup>(11)</sup>	77.8	77.8	75.9	75.9	145
150		49.6 <sup>(9)</sup>		56.8 <sup>(11)</sup>		60.9 <sup>(11)</sup>		67.3 <sup>(11)</sup>	74.1	74.1	72.2	72.2	150
155		45.3 <sup>(9)</sup>		51.6 <sup>(11)</sup>		56.5 <sup>(11)</sup>		62.2 <sup>(11)</sup>	67.7*	67.7	68.8	68.8	155
160		41.1 <sup>(9)</sup>		46.4 <sup>(11)</sup>		52.3 <sup>(11)</sup>		57.6 <sup>(11)</sup>	64.6*	64.6	65.6	65.6	160
165		36.8 <sup>(9)</sup>		42.0 <sup>(9)</sup>		48.1 <sup>(11)</sup>		53.0 <sup>(11)</sup>		57.3 <sup>(11)</sup>	62.7	62.7	165
170		32.8 <sup>(7)</sup>		38.5 <sup>(9)</sup>		43.9 <sup>(11)</sup>		48.5 <sup>(11)</sup>		52.7 <sup>(11)</sup>	59.9	59.9	170
175		29.8 <sup>(7)</sup>		35.0 <sup>(9)</sup>		39.7 <sup>(11)</sup>		45.0 <sup>(11)</sup>		48.7 <sup>(11)</sup>	54.6*	54.6	175
180		26.9 <sup>(7)</sup>		31.5 <sup>(9)</sup>		35.5 <sup>(11)</sup>		41.5 <sup>(11)</sup>		44.9 <sup>(11)</sup>	52.3*	52.3	180
185		24.0 <sup>(7)</sup>		28.0 <sup>(9)</sup>		31.9 <sup>(9)</sup>		38.0 <sup>(11)</sup>		41.2 <sup>(11)</sup>		45.4 <sup>(11)</sup>	185
190		21.1 <sup>(6)</sup>		24.6 <sup>(7)</sup>		29.1 <sup>(9)</sup>		34.5 <sup>(11)</sup>		37.6 <sup>(11)</sup>		41.6 <sup>(11)</sup>	190
195				22.2 <sup>(7)</sup>		26.3 <sup>(9)</sup>		31.0 <sup>(11)</sup>		34.7 <sup>(11)</sup>		38.4 <sup>(11)</sup>	195
200				19.8 <sup>(7)</sup>		23.4 <sup>(9)</sup>		27.5 <sup>(11)</sup>		31.8 <sup>(11)</sup>		35.3 <sup>(11)</sup>	200
205				17.4 <sup>(7)</sup>		20.6 <sup>(9)</sup>		24.5 <sup>(9)</sup>		28.9 <sup>(11)</sup>		32.1 <sup>(11)</sup>	205
210				14.9 <sup>(7)</sup>		17.6 <sup>(7)</sup>		22.2 <sup>(9)</sup>		26.0 <sup>(11)</sup>		29.2 <sup>(11)</sup>	210
215						15.4 <sup>(7)</sup>		19.9 <sup>(9)</sup>		23.1 <sup>(11)</sup>		26.8 <sup>(11)</sup>	215
220						13.3 <sup>(7)</sup>		17.7 <sup>(9)</sup>		20.2 <sup>(11)</sup>		24.4 <sup>(11)</sup>	220
225						11.1 <sup>(7)</sup>		15.4 <sup>(9)</sup>		17.4 <sup>(9)</sup>		22.1 <sup>(11)</sup>	225
230						9.0 <sup>(7)</sup>		12.7 <sup>(7)</sup>		15.4 <sup>(9)</sup>		19.7 <sup>(11)</sup>	230
235								10.6 <sup>(7)</sup>		13.4 <sup>(9)</sup>		17.3 <sup>(11)</sup>	235
240										11.4 <sup>(9)</sup>		15.0 <sup>(11)</sup>	240
245										9.4 <sup>(9)</sup>		12.2 <sup>(9)</sup>	245

1) 12°; 2) 17°; 3) 22°; 4) 27°; 5) 32°; 6) 37°; 7) 42°; 8) 47°; 9) 52°; 10) 57°; 11) 62°

# Lifting capacities Forces de levage

SW







ft	S 177												ft
	W 177		W 197		W 217		W 236		W 256		W 276		
	87/85*	Wmax	87/85*	Wmax	87/85*	Wmax	87/85*	Wmax	87/85*	Wmax	87/85*	Wmax	
70	170.0	170.0											70
75	158.0	158.0	153.0	153.0									75
80	148.0	148.0	144.0	144.0	138.0	138.0							80
85	139.0	139.0	135.0	135.0	130.0	130.0	122.0	122.0					85
90	131.0	131.0	127.0	127.0	122.0	122.0	119.0	119.0	106.0	106.0			90
95	124.0	124.0	120.0	120.0	115.0	115.0 <sup>(2)</sup>	112.0	112.0	104.0	104.0	91.8	91.8	95
100	117.0	117.0	113.0	113.0	109.0	109.0	105.0	105.0	102.0	102.0	90.1	90.1	100
105	111.0	111.0	107.0	107.0 <sup>(3)</sup>	103.0	103.0	99.8	99.8	96.7	96.7	88.5	88.5	105
110	105.0	105.0 <sup>(4)</sup>	102.0	102.0	97.7	97.7	94.5	94.5	91.7	91.7	87.0	87.0	110
115	99.9	99.9	96.7	96.7	92.7	92.7	89.6	89.6	86.9	86.9	83.7	83.7 <sup>(2)</sup>	115
120	95.1	95.1	92.0	92.0	88.1	88.1	85.1	85.1	82.5	82.5	79.5	79.5	120
125	90.6	90.6	87.6	87.6	83.9	83.9	80.9	80.9	78.3	78.3	75.4	75.4	125
130	86.5	86.5	83.5	83.5	79.9	79.9	77.0	77.0	74.5	74.5	71.7	71.7	130
135	82.4	82.4	79.7	79.7	76.1	76.1	73.4	73.4	70.9	70.9	68.1	68.1	135
140	78.1	78.1	76.1	76.1	72.7	72.7	69.9	69.9	67.5	67.5	64.8	64.8	140
145	74.2	74.2 <sup>(7)</sup>	72.4	72.4	69.4	69.4	66.7	66.7	64.4	64.4	61.8	61.8	145
150	70.5	70.5	68.7	68.7	66.2	66.2	63.7	63.7	61.4	61.4	58.8	58.8	150
155	67.1	67.1	65.4	65.4	62.9	62.9	60.8	60.8	58.6	58.6	56.1	56.1	155
160	63.9	63.9	62.2	62.2	59.8	59.8	58.0	58.0	56.0	56.0	53.5	53.5	160
165	61.0	61.0	59.3	59.3	56.8	56.8	55.0	55.0	53.4	53.4	51.0	51.0	165
170	58.2	58.2	56.5	56.5	54.1	54.1	52.3	52.3	50.7	50.7	48.6	48.6	170
175	55.6	55.6	53.9	53.9	51.5	51.5	49.8	49.8	48.1	48.1	46.3	46.3	175
180	53.1	53.1	51.5	51.5	49.1	49.1	47.4	47.4	45.7	45.7	43.9	43.9	180
185	50.8	50.8	49.2	49.2	46.8	46.8	45.1	45.1	43.5	43.5	41.7	41.7	185
190	48.7	48.7	47.0	47.0	44.7	44.7	43.0	43.0	41.3	41.3	39.5	39.5	190
195	44.1*	44.1	45.0	45.0	42.7	42.7	40.9	40.9	39.4	39.4	37.5	37.5	195
200	42.3*	42.3	43.1	43.1	40.8	40.8	39.0	39.0	37.5	37.5	35.7	35.7	200
205		35.8 <sup>(11)</sup>	41.3	41.3	39.0	39.0	37.3	37.3	35.7	35.7	33.9	33.9	205
210		32.7 <sup>(11)</sup>	39.6	39.6	37.3	37.3	35.5	35.5	33.9	33.9	32.2	32.2	210
215		30.0 <sup>(11)</sup>	35.7*	35.7	35.7	35.7	33.9	33.9	32.3	32.3	30.6	30.6	215
220		27.2 <sup>(11)</sup>	34.3*	34.3	34.1	34.1	32.4	32.4	30.8	30.8	29.0	29.0	220
225		24.5 <sup>(11)</sup>		27.9 <sup>(11)</sup>	32.7	32.7	31.0	31.0	29.3	29.3	27.6	27.6	225
230		22.1 <sup>(11)</sup>		25.4 <sup>(11)</sup>	31.4	31.4	29.6	29.6	27.9	27.9	26.2	26.2	230
235		20.2 <sup>(11)</sup>		23.3 <sup>(11)</sup>	27.9*	27.9	28.3	28.3	26.6	26.6	24.9	24.9	235
240		18.2 <sup>(11)</sup>		21.1 <sup>(11)</sup>		23.1 <sup>(11)</sup>	27.1	27.1	25.3	25.3	23.6	23.6	240
245		16.3 <sup>(11)</sup>		18.9 <sup>(11)</sup>		20.8 <sup>(11)</sup>	25.9	25.9	24.1	24.1	22.4	22.4 <sup>(9)</sup>	245
250		14.4 <sup>(11)</sup>		16.9 <sup>(11)</sup>		18.9 <sup>(11)</sup>	24.9	24.9	23.0	23.0	21.4	21.4	250
255		12.4 <sup>(11)</sup>		15.0 <sup>(11)</sup>		17.1 <sup>(11)</sup>	21.8*	21.8	22.0	22.0	20.5	20.5	255
260		10.4 <sup>(11)</sup>		13.2 <sup>(11)</sup>		15.4 <sup>(11)</sup>		17.6 <sup>(11)</sup>	21.1	21.1	19.6	19.6	260
265				11.3 <sup>(11)</sup>		13.6 <sup>(11)</sup>		15.8 <sup>(11)</sup>	20.3	20.3	18.7	18.7	265
270				9.5 <sup>(11)</sup>		6.6 <sup>(7)</sup>		14.1 <sup>(11)</sup>	19.5	19.5	17.9	17.9	270
275				7.6 <sup>(11)</sup>				12.5 <sup>(11)</sup>	17.1*	17.1	17.2	17.2	275
280				5.8 <sup>(11)</sup>				10.9 <sup>(11)</sup>		12.9 <sup>(11)</sup>	16.5	16.5	280
285								9.3 <sup>(11)</sup>		11.3 <sup>(11)</sup>	15.8	15.8	285
290										9.5 <sup>(11)</sup>	15.2	15.2	290
295										7.8 <sup>(11)</sup>	12.9*	12.9	295
300												8.3 <sup>(11)</sup>	300
305												5.0 <sup>(10)</sup>	305
310												3.4 <sup>(10)</sup>	310

1) 12°; 2) 17°; 3) 22°; 4) 27°; 5) 32°; 6) 37°; 7) 42°; 8) 47°; 9) 52°; 10) 57°; 11) 62°

# Lifting capacities Forces de levage

SW

98-217 ft	59-276 ft	88,200 lbs	374,800 lbs
			
			330,700 lbs
			286,600 lbs

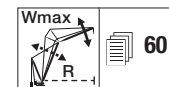

ft	S 197												ft
	W 59		W 79		W 98		W 118		W 138		W 157		
	87/85*	Wmax	87/85*	Wmax	87/85*	Wmax	87/85*	Wmax	87/85*	Wmax	87/85*	Wmax	
36	373.0												36
38	355.0	355.0 <sup>(1)</sup>											38
40	339.0	339.0											40
45	304.0	304.0	293.0	293.0									45
50	275.0	275.0	266.0	266.0 <sup>(2)</sup>	257.0	257.0							50
55	252.0	252.0 <sup>(3)</sup>	244.0	244.0	235.0	235.0	227.0	227.0					55
60	232.0	232.0	224.0	224.0	216.0	216.0	209.0	209.0	202.0	202.0 <sup>(1)</sup>			60
65	214.0	214.0	207.0	207.0	200.0	200.0	194.0	194.0	188.0	188.0	181.0	181.0	65
70	200.0	200.0	193.0	193.0	186.0	186.0	180.0	180.0	175.0	175.0	168.0	168.0	70
75	187.0	187.0	180.0	180.0	174.0	174.0	169.0	169.0	163.0	163.0	157.0	157.0	75
80	168.0*	169.0 <sup>(11)</sup>	169.0	169.0	163.0	163.0	158.0	158.0	153.0	153.0 <sup>(3)</sup>	147.0	147.0	80
85		156.0 <sup>(11)</sup>	159.0	159.0 <sup>(9)</sup>	153.0	153.0 <sup>(6)</sup>	149.0	149.0	144.0	144.0	138.0	138.0	85
90		143.0 <sup>(11)</sup>	151.0	151.0	145.0	145.0	140.0	140.0 <sup>(5)</sup>	135.0	135.0	130.0	130.0 <sup>(9)</sup>	90
95		131.0 <sup>(11)</sup>	143.0	143.0	137.0	137.0	132.0	132.0	128.0	128.0	123.0	123.0	95
100		119.0 <sup>(11)</sup>	129.0*	129.0 <sup>(11)</sup>	130.0	130.0	125.0	125.0	121.0	121.0	116.0	116.0 <sup>(4)</sup>	100
105		109.0 <sup>(11)</sup>		119.0 <sup>(11)</sup>	123.0	123.0	119.0	119.0 <sup>(7)</sup>	115.0	115.0	110.0	110.0	105
110		100.0 <sup>(11)</sup>		109.0 <sup>(11)</sup>	117.0	117.0	113.0	113.0	109.0	109.0 <sup>(6)</sup>	105.0	105.0	110
115		90.7 <sup>(11)</sup>		99.9 <sup>(11)</sup>	110.0	110.0	108.0	108.0	104.0	104.0	99.7	99.7	115
120		83.1 <sup>(11)</sup>		91.3 <sup>(11)</sup>	99.8*	99.8	102.0	102.0	99.2	99.2	95.0	95.0	120
125		77.1 <sup>(11)</sup>		84.3 <sup>(11)</sup>		91.6 <sup>(11)</sup>	96.9	96.9	94.7	94.7	90.6	90.6	125
130		71.1 <sup>(11)</sup>		77.4 <sup>(11)</sup>		84.3 <sup>(11)</sup>	91.8	91.8	89.8	89.8	86.5	86.5	130
135		65.1 <sup>(11)</sup>		70.4 <sup>(11)</sup>		77.0 <sup>(11)</sup>	87.0	87.0	85.2	85.2	82.6	82.6	135
140		59.1 <sup>(10)</sup>		65.0 <sup>(11)</sup>		70.9 <sup>(11)</sup>	79.1*	79.1	80.9	80.9	78.4	78.4	140
145		53.1 <sup>(10)</sup>		60.2 <sup>(11)</sup>		65.5 <sup>(11)</sup>		71.9 <sup>(11)</sup>	76.9	76.9	74.5	74.5	145
150		47.1 <sup>(10)</sup>		55.5 <sup>(11)</sup>		60.1 <sup>(11)</sup>		66.2 <sup>(11)</sup>	73.3	73.3	70.8	70.8	150
155		43.0 <sup>(9)</sup>		50.7 <sup>(11)</sup>		54.7 <sup>(11)</sup>		60.5 <sup>(11)</sup>	69.8	69.8	67.5	67.5	155
160		39.3 <sup>(9)</sup>		46.0 <sup>(11)</sup>		50.5 <sup>(11)</sup>		56.0 <sup>(11)</sup>	63.3*	63.3	64.3	64.3	160
165		35.5 <sup>(9)</sup>		41.3 <sup>(11)</sup>		46.7 <sup>(11)</sup>		51.6 <sup>(11)</sup>		56.8 <sup>(11)</sup>	61.4	61.4	165
170		31.8 <sup>(9)</sup>		36.5 <sup>(11)</sup>		42.8 <sup>(11)</sup>		47.3 <sup>(11)</sup>		52.2 <sup>(11)</sup>	58.7	58.7	170
175		28.0 <sup>(9)</sup>		33.2 <sup>(9)</sup>		38.9 <sup>(11)</sup>		42.9 <sup>(11)</sup>		47.7 <sup>(11)</sup>	56.1	56.1	175
180		24.3 <sup>(9)</sup>		30.2 <sup>(9)</sup>		35.0 <sup>(11)</sup>		39.7 <sup>(11)</sup>		44.0 <sup>(11)</sup>	50.7*	50.7	180
185		21.6 <sup>(7)</sup>		27.2 <sup>(9)</sup>		31.1 <sup>(11)</sup>		36.5 <sup>(11)</sup>		40.4 <sup>(11)</sup>		44.4 <sup>(11)</sup>	185
190		19.1 <sup>(7)</sup>		24.2 <sup>(9)</sup>		27.2 <sup>(11)</sup>		33.2 <sup>(11)</sup>		36.8 <sup>(11)</sup>		40.5 <sup>(11)</sup>	190
195		16.6 <sup>(7)</sup>		21.2 <sup>(9)</sup>		24.5 <sup>(9)</sup>		30.0 <sup>(11)</sup>		33.3 <sup>(11)</sup>		37.0 <sup>(11)</sup>	195
200		14.0 <sup>(7)</sup>		18.2 <sup>(9)</sup>		22.1 <sup>(9)</sup>		26.8 <sup>(11)</sup>		30.6 <sup>(11)</sup>		33.9 <sup>(11)</sup>	200
205		11.5 <sup>(6)</sup>		15.7 <sup>(7)</sup>		19.7 <sup>(9)</sup>		23.5 <sup>(11)</sup>		28.0 <sup>(11)</sup>		30.8 <sup>(11)</sup>	205
210				13.4 <sup>(7)</sup>		17.2 <sup>(9)</sup>		19.9 <sup>(9)</sup>		25.4 <sup>(11)</sup>		27.8 <sup>(11)</sup>	210
215				11.2 <sup>(7)</sup>		14.8 <sup>(9)</sup>		17.8 <sup>(9)</sup>		22.7 <sup>(11)</sup>		25.0 <sup>(11)</sup>	215
220				8.9 <sup>(7)</sup>		12.4 <sup>(9)</sup>		15.6 <sup>(9)</sup>		20.1 <sup>(11)</sup>		22.7 <sup>(11)</sup>	220
225				6.7 <sup>(7)</sup>				13.5 <sup>(9)</sup>		17.4 <sup>(11)</sup>		20.5 <sup>(11)</sup>	225
230								11.4 <sup>(9)</sup>				18.3 <sup>(11)</sup>	230
235								9.2 <sup>(9)</sup>				16.1 <sup>(11)</sup>	235
240												13.9 <sup>(11)</sup>	240
245												11.6 <sup>(11)</sup>	245

1) 12°; 2) 17°; 3) 22°; 4) 27°; 5) 32°; 6) 37°; 7) 42°; 8) 47°; 9) 52°; 10) 57°; 11) 62°

# Lifting capacities Forces de levage

SW









ft	S 197												ft
	W 177		W 197		W 217		W 236		W 256		W 276		
	87/85*	Wmax	87/85*	Wmax	87/85*	Wmax	87/85*	Wmax	87/85*	Wmax	87/85*	Wmax	
70	163.0	163.0 <sup>(1)</sup>											70
75	153.0	153.0	147.0	147.0									75
80	143.0	143.0	139.0	139.0	130.0	130.0							80
85	134.0	134.0	130.0	130.0	125.0	125.0	114.0	114.0					85
90	127.0	127.0	123.0	123.0	118.0	118.0	111.0	111.0	99.2	99.2			90
95	119.0	119.0	116.0	116.0	111.0	111.0	108.0	108.0	97.2	97.2	85.9	85.9	95
100	113.0	113.0	109.0	109.0	105.0	105.0	102.0	102.0	95.2	95.2	84.3	84.3	100
105	107.0	107.0	104.0	104.0 <sup>(3)</sup>	99.5	99.5	96.2	96.2	93.1	93.1	82.8	82.8	105
110	102.0	102.0	98.3	98.3	94.2	94.2	91.0	91.0	88.2	88.2	81.4	81.4	110
115	96.5	96.5	93.3	93.3	89.4	89.4	86.4	86.4	83.7	83.7	79.9	79.9	115
120	91.9	91.9	88.8	88.8	85.0	85.0	82.0	82.0	79.4	79.4	76.4	76.4	120
125	87.6	87.6	84.5	84.5	80.8	80.8	77.9	77.9	75.3	75.3	72.4	72.4	125
130	83.6	83.6	80.6	80.6	76.9	76.9	74.1	74.1	71.7	71.7	68.9	68.9	130
135	79.8	79.8 <sup>(6)</sup>	77.0	77.0	73.4	73.4	70.6	70.6	68.2	68.2	65.4	65.4	135
140	76.3	76.3	73.6	73.6	70.0	70.0	67.3	67.3	64.9	64.9	62.2	62.2	140
145	72.7	72.7	70.4	70.4	66.9	66.9	64.2	64.2	61.9	61.9	59.3	59.3	145
150	69.1	69.1	67.2	67.2	63.9	63.9	61.3	61.3	59.0	59.0	56.4	56.4	150
155	65.8	65.8	64.0	64.0	61.1	61.1	58.6	58.6	56.3	56.3	53.8	53.8	155
160	62.6	62.6	60.9	60.9	58.4	58.4	55.9	55.9	53.8	53.8	51.2	51.2	160
165	59.7	59.7	58.0	58.0	55.5	55.5	53.5	53.5	51.3	51.3	48.9	48.9	165
170	56.9	56.9	55.2	55.2	52.8	52.8	51.0	51.0	49.1	49.1	46.6	46.6	170
175	54.4	54.4	52.7	52.7	50.3	50.3	48.5	48.5	46.8	46.8	44.5	44.5	175
180	52.0	52.0	50.3	50.3	47.9	47.9	46.1	46.1	44.5	44.5	42.5	42.5	180
185	49.7	49.7	48.0	48.0	45.6	45.6	43.9	43.9	42.3	42.3	40.4	40.4	185
190	47.6	47.6	45.9	45.9	43.5	43.5	41.8	41.8	40.2	40.2	38.3	38.3	190
195	45.6	45.6	43.9	43.9	41.5	41.5	39.8	39.8	38.2	38.2	36.4	36.4	195
200	40.9*	40.9	42.0	42.0	39.6	39.6	37.9	37.9	36.3	36.3	34.5	34.5	200
205		34.8 <sup>(11)</sup>	40.2	40.2	37.9	37.9	36.1	36.1	34.5	34.5	32.7	32.7	205
210		31.5 <sup>(11)</sup>	38.6	38.6	36.2	36.2	34.5	34.5	32.8	32.8	31.1	31.1	210
215		28.8 <sup>(11)</sup>	34.3*	34.3	34.6	34.6	32.9	32.9	31.3	31.3	29.5	29.5	215
220		26.2 <sup>(11)</sup>	32.9*	32.9	33.1	33.1	31.3	31.3	29.7	29.7	28.0	28.0	220
225		23.6 <sup>(11)</sup>		26.9 <sup>(11)</sup>	31.7	31.7	29.9	29.9	28.3	28.3	26.5	26.5	225
230		21.1 <sup>(11)</sup>		24.1 <sup>(11)</sup>	30.4	30.4	28.6	28.6	26.9	26.9 <sup>(9)</sup>	25.2	25.2	230
235		18.8 <sup>(11)</sup>		22.0 <sup>(11)</sup>	26.5*	26.5	27.3	27.3	25.6	25.6	23.9	23.9	235
240		16.7 <sup>(11)</sup>		20.0 <sup>(11)</sup>	25.4*	25.4	26.1	26.1	24.4	24.4	22.6	22.6	240
245		14.6 <sup>(11)</sup>		17.9 <sup>(11)</sup>		20.1 <sup>(11)</sup>	24.9	24.9	23.2	23.2	21.6	21.6	245
250		12.6 <sup>(11)</sup>		15.9 <sup>(11)</sup>		17.9 <sup>(11)</sup>	23.9	23.9	22.1	22.1	20.6	20.6	250
255		10.5 <sup>(11)</sup>		10.3 <sup>(8)</sup>		16.0 <sup>(11)</sup>	20.7*	20.7	21.2	21.2	19.7	19.7	255
260		8.4 <sup>(11)</sup>				14.2 <sup>(11)</sup>	20.0*	20.0	20.3	20.3	18.8	18.8	260
265						12.4 <sup>(11)</sup>		14.9 <sup>(11)</sup>	19.5	19.5	18.0	18.0	265
270						10.6 <sup>(11)</sup>		13.1 <sup>(11)</sup>	18.8	18.8	17.2	17.2	270
275								11.3 <sup>(11)</sup>	16.1*	16.1	16.4	16.4	275
280								9.4 <sup>(11)</sup>	15.5*	15.5	15.7	15.7	280
285								7.6 <sup>(11)</sup>		10.1 <sup>(11)</sup>	15.1	15.1	285
290								5.7 <sup>(11)</sup>		8.3 <sup>(11)</sup>	14.5	14.5	290
295										6.5 <sup>(11)</sup>	12.0*	12.0	295
300											11.6*	11.6	300

1) 12°; 2) 17°; 3) 22°; 4) 27°; 5) 32°; 6) 37°; 7) 42°; 8) 47°; 9) 52°; 10) 57°; 11) 62°

# Lifting capacities Forces de levage

SW

98-217 ft	59-276 ft	88,200 lbs	374,800 lbs
			
			330,700 lbs
			286,600 lbs

		60
---	---	----

ft	S 217														ft		
	W 59		W 79		W 98		W 118		W 138		W 157		W 177			W 197	
	87/85*	Wmax	87/85*	Wmax	87/85*	Wmax	87/85*	Wmax	87/85*	Wmax	87/85*	Wmax	87/85*	Wmax		87/85*	Wmax
38	331.0	331.0 <sup>(1)</sup>															38
40	324.0	324.0															40
45	293.0	293.0	279.0	279.0													45
50	266.0	266.0	257.0	257.0	243.0	243.0											50
55	243.0	243.0	235.0	235.0	227.0	227.0	213.0	213.0									55
60	224.0	224.0 <sup>(9)</sup>	217.0	217.0	209.0	209.0	203.0	203.0	187.0	187.0							60
65	208.0	208.0	201.0	201.0	194.0	194.0	188.0	188.0	181.0	181.0	166.0	166.0					65
70	194.0	194.0	187.0	187.0	181.0	181.0	175.0	175.0	168.0	168.0 <sup>(2)</sup>	161.0	161.0	147.0	147.0			70
75	182.0	182.0	175.0	175.0	169.0	169.0	164.0	164.0	158.0	158.0	152.0	152.0	143.0	143.0	130.0	130.0	75
80	162.0*	165.0 <sup>(11)</sup>	164.0	164.0	158.0	158.0 <sup>(9)</sup>	154.0	154.0	148.0	148.0	142.0	142.0	138.0	138.0	127.0	127.0	80
85	153.0*	153.0	155.0	155.0	149.0	149.0	144.0	144.0	139.0	139.0	134.0	134.0	130.0	130.0	123.0	123.0	85
90		140.0 <sup>(11)</sup>	146.0	146.0 <sup>(10)</sup>	141.0	141.0	136.0	136.0 <sup>(9)</sup>	131.0	131.0	126.0	126.0 <sup>(9)</sup>	122.0	122.0	118.0	118.0 <sup>(2)</sup>	90
95		129.0 <sup>(11)</sup>	139.0	139.0	133.0	133.0	129.0	129.0	124.0	124.0	119.0	119.0	115.0	115.0	112.0	112.0	95
100		117.0 <sup>(11)</sup>	125.0*	126.0 <sup>(11)</sup>	126.0	126.0	122.0	122.0	117.0	117.0	113.0	113.0	109.0	109.0	106.0	106.0	100
105		107.0 <sup>(11)</sup>	119.0*	119.0	120.0	120.0	116.0	116.0	111.0	111.0	107.0	107.0	103.0	103.0	100.0	100.0	105
110		98.6 <sup>(11)</sup>		108.0 <sup>(11)</sup>	115.0	115.0	110.0	110.0	106.0	106.0	101.0	101.0	98.1	98.1	94.8	94.8	110
115		90.3 <sup>(11)</sup>		98.9 <sup>(11)</sup>	109.0	109.0	105.0	105.0	101.0	101.0	96.3	96.3	93.3	93.3	90.1	90.1	115
120		82.0 <sup>(11)</sup>		90.2 <sup>(11)</sup>	98.1*	98.1	101.0	101.0	96.0	96.0	91.8	91.8	88.8	88.8	85.7	85.7	120
125		75.1 <sup>(11)</sup>		82.9 <sup>(11)</sup>	92.6*	92.6	95.8	95.8	91.7	91.7	87.6	87.6	84.6	84.6	81.6	81.6	125
130		69.6 <sup>(11)</sup>		76.5 <sup>(11)</sup>		83.7 <sup>(11)</sup>	90.7	90.7	87.7	87.7	83.6	83.6	80.7	80.7	77.8	77.8	130
135		64.2 <sup>(11)</sup>		70.0 <sup>(11)</sup>		76.7 <sup>(11)</sup>	86.1	86.1	83.6	83.6	79.9	79.9	77.1	77.1	74.3	74.3	135
140		58.8 <sup>(10)</sup>		63.5 <sup>(11)</sup>		69.7 <sup>(11)</sup>	77.7*	77.7	79.4	79.4	76.6	76.6	73.7	73.7	71.0	71.0	140
145		53.4 <sup>(10)</sup>		58.4 <sup>(11)</sup>		64.4 <sup>(11)</sup>		71.3 <sup>(11)</sup>	75.5	75.5	73.0	73.0	70.6	70.6	67.8	67.8	145
150		48.0 <sup>(10)</sup>		54.0 <sup>(11)</sup>		59.3 <sup>(11)</sup>		65.8 <sup>(11)</sup>	71.9	71.9	69.4	69.4	67.6	67.6	64.9	64.9	150
155		42.6 <sup>(10)</sup>		49.7 <sup>(11)</sup>		54.2 <sup>(11)</sup>		60.3 <sup>(11)</sup>	68.5	68.5	66.1	66.1	64.4	64.4	62.2	62.2	155
160		37.6 <sup>(9)</sup>		45.3 <sup>(11)</sup>		49.1 <sup>(11)</sup>		55.0 <sup>(11)</sup>	61.6*	61.6	63.0	63.0	61.3	61.3	59.5	59.5	160
165		34.4 <sup>(9)</sup>		41.0 <sup>(11)</sup>		45.2 <sup>(11)</sup>		50.8 <sup>(11)</sup>		55.7 <sup>(11)</sup>	60.1	60.1	58.4	58.4	56.6	56.6	165
170		31.2 <sup>(9)</sup>		36.7 <sup>(11)</sup>		41.7 <sup>(11)</sup>		46.7 <sup>(11)</sup>		51.2 <sup>(11)</sup>	57.4	57.4	55.7	55.7	54.0	54.0	170
175		28.0 <sup>(9)</sup>		32.3 <sup>(11)</sup>		38.1 <sup>(11)</sup>		42.5 <sup>(11)</sup>		46.7 <sup>(11)</sup>	54.9	54.9	53.1	53.1	51.4	51.4	175
180		24.9 <sup>(9)</sup>		28.3 <sup>(9)</sup>		34.5 <sup>(11)</sup>		38.3 <sup>(11)</sup>		42.7 <sup>(11)</sup>	49.1*	49.1	50.8	50.8	49.0	49.0	180
185		21.7 <sup>(9)</sup>		25.7 <sup>(9)</sup>		30.9 <sup>(11)</sup>		35.4 <sup>(11)</sup>		39.2 <sup>(11)</sup>		43.3 <sup>(11)</sup>	48.5	48.5	46.8	46.8	185
190		18.5 <sup>(9)</sup>		23.1 <sup>(9)</sup>		27.3 <sup>(11)</sup>		32.4 <sup>(11)</sup>		35.7 <sup>(11)</sup>		39.6 <sup>(11)</sup>	46.4	46.4	44.7	44.7	190
195				20.5 <sup>(9)</sup>		23.8 <sup>(11)</sup>		29.5 <sup>(11)</sup>		32.2 <sup>(11)</sup>		35.9 <sup>(11)</sup>	44.5	44.5	42.8	42.8	195
200				17.8 <sup>(9)</sup>		20.2 <sup>(9)</sup>		26.6 <sup>(11)</sup>		28.8 <sup>(11)</sup>		32.7 <sup>(11)</sup>	39.4*	39.4	40.9	40.9	200
205				15.2 <sup>(9)</sup>		17.9 <sup>(9)</sup>		23.7 <sup>(11)</sup>		26.3 <sup>(11)</sup>		29.7 <sup>(11)</sup>		33.9 <sup>(11)</sup>	39.1	39.1	205
210				12.6 <sup>(9)</sup>		15.6 <sup>(9)</sup>		20.8 <sup>(11)</sup>		23.8 <sup>(11)</sup>		26.8 <sup>(11)</sup>		30.7 <sup>(11)</sup>	37.5	37.5	210
215						13.3 <sup>(9)</sup>		17.8 <sup>(11)</sup>		21.3 <sup>(11)</sup>		23.8 <sup>(11)</sup>		27.5 <sup>(11)</sup>	36.0	36.0	215
220						11.0 <sup>(9)</sup>				18.8 <sup>(11)</sup>		21.1 <sup>(11)</sup>		25.1 <sup>(11)</sup>	31.5*	31.5	220
225						8.7 <sup>(9)</sup>				16.4 <sup>(11)</sup>		18.8 <sup>(11)</sup>		22.7 <sup>(11)</sup>		26.1 <sup>(11)</sup>	225
230						6.4 <sup>(9)</sup>				13.9 <sup>(11)</sup>		16.6 <sup>(11)</sup>		20.3 <sup>(11)</sup>		23.4 <sup>(11)</sup>	230
235										11.4 <sup>(11)</sup>		14.4 <sup>(11)</sup>		17.9 <sup>(11)</sup>		20.8 <sup>(11)</sup>	235
240												12.1 <sup>(11)</sup>		8.9 <sup>(9)</sup>		18.8 <sup>(11)</sup>	240
245												9.9 <sup>(11)</sup>				16.9 <sup>(11)</sup>	245
250																14.9 <sup>(11)</sup>	250
255																12.9 <sup>(11)</sup>	255

1) 12°; 2) 17°; 3) 22°; 4) 27°; 5) 32°; 6) 37°; 7) 42°; 8) 47°; 9) 52°; 10) 57°; 11) 62°

# Lifting heights Hauteurs de levage

SW

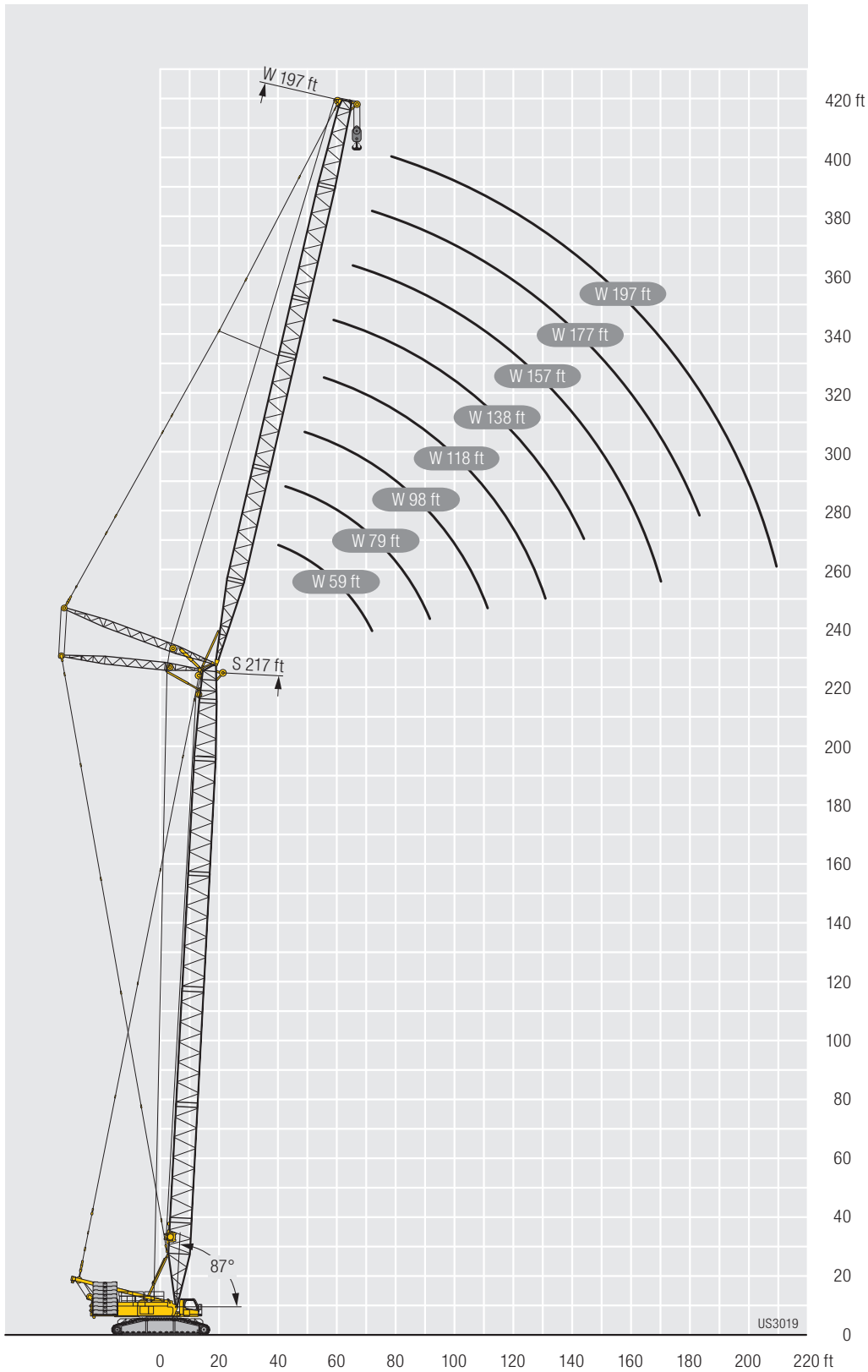

# Lifting heights Hauteurs de levage

SW

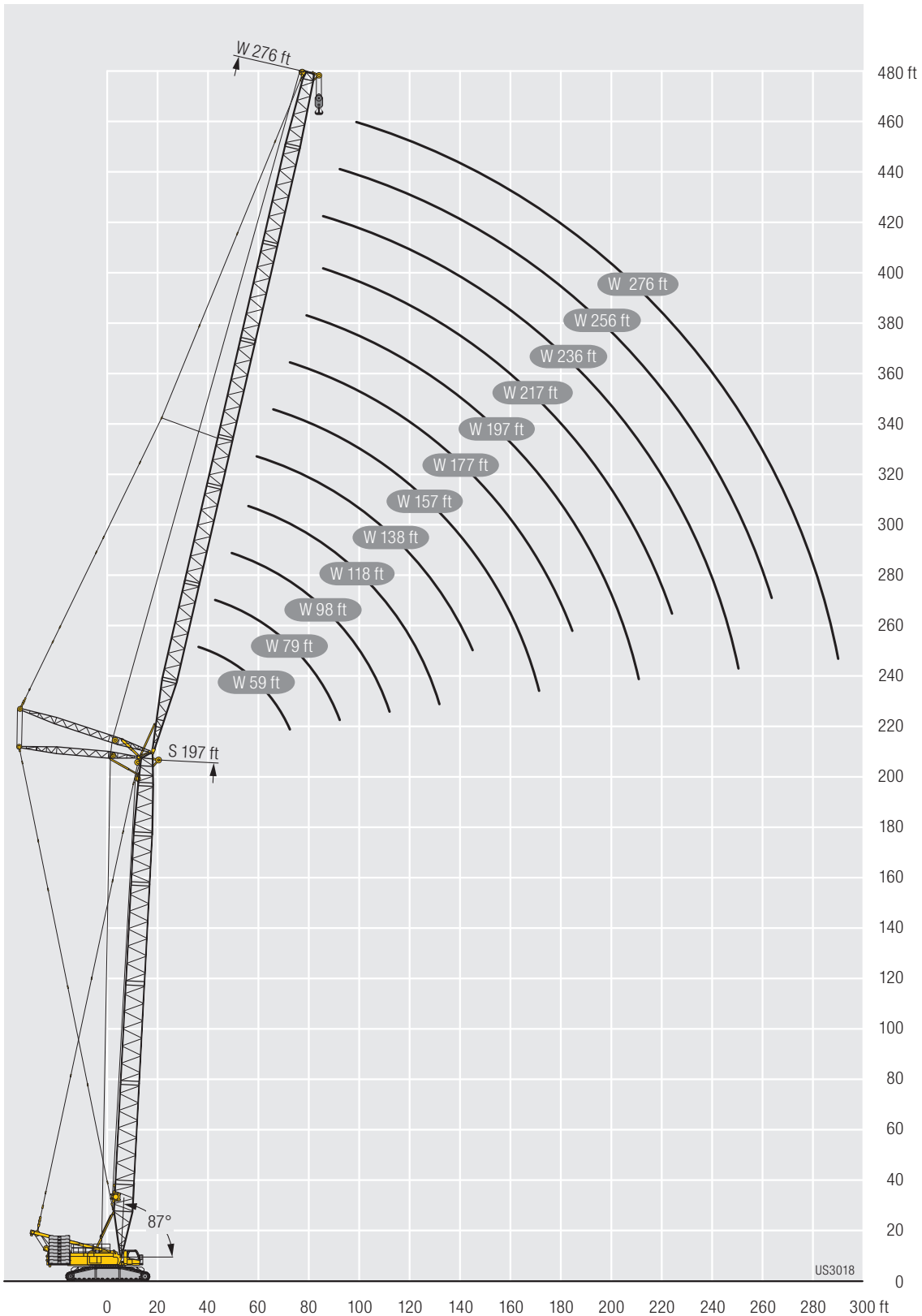



# Lifting capacities Forces de levage

SDWB

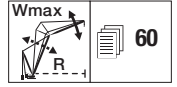
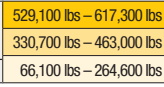

ft	S	S 118																							
		W 59		W 79		W 98		W 118		W 138		W 157		W 177		W 197		W 217		W 236		W 256		W 276	
		85	Wmax	87*/85	Wmax	87*/85	Wmax	87*/85	Wmax	87*/85	Wmax	87*/85	Wmax	87*/85	Wmax	87*/85	Wmax	87*/85	Wmax	87*/85	Wmax	87*/85	Wmax	87*/85	Wmax
38	-	399.0	399.0	382.0*	382.0 <sup>(1)</sup>																				
38	B	551.0	551.0	488.0*	488.0 <sup>(1)</sup>																				
40	-	379.0	380.0 <sup>(1)</sup>	370.0*	370.0 <sup>(1)</sup>																				
40	B	551.0	551.0	487.0*	489.0 <sup>(1)</sup>																				
45	-	336.0	341.0 <sup>(3)</sup>	329.0*	329.0 <sup>(3)</sup>	315.0*	315.0 <sup>(1)</sup>																		
45	B	551.0	551.0	490.0	490.0 <sup>(1)</sup>	490.0*	490.0 <sup>(1)</sup>																		
50	-	301.0	305.0 <sup>(3)</sup>	296.0*	296.0*	284.0*	284.0*	274.0*	274.0 <sup>(1)</sup>																
50	B	533.0	551.0 <sup>(1)</sup>	489.0	490.0 <sup>(1)</sup>	490.0	490.0 <sup>(1)</sup>	396.0*	398.0 <sup>(1)</sup>																
55	-	272.0	278.0 <sup>(3)</sup>	268.0*	268.0*	257.0*	257.0*	249.0*	249.0*	240.0*	240.0 <sup>(1)</sup>														
55	B	505.0	547.0 <sup>(1)</sup>	488.0	490.0 <sup>(1)</sup>	485.0	490.0 <sup>(1)</sup>	401.0	401.0 <sup>(1)</sup>	369.0*	372.0 <sup>(1)</sup>														
60	-	249.0	253.0 <sup>(3)</sup>	245.0*	245.0*	235.0*	235.0 <sup>(3)</sup>	228.0*	228.0*	220.0*	220.0*	214.0*	214.0*												
60	B	481.0	539.0 <sup>(1)</sup>	485.0	490.0 <sup>(1)</sup>	466.0	490.0 <sup>(1)</sup>	401.0	402.0 <sup>(1)</sup>	375.0	375.0	309.0*	309.0 <sup>(1)</sup>												
65	-	229.0	234.0 <sup>(3)</sup>	226.0*	226.0*	217.0*	217.0*	210.0*	210.0*	203.0*	203.0 <sup>(3)</sup>	197.0*	197.0*	191.0*	191.0 <sup>(1)</sup>										
65	B	443.0	518.0 <sup>(1)</sup>	470.0	490.0 <sup>(2)</sup>	444.0	490.0 <sup>(1)</sup>	399.0	404.0 <sup>(1)</sup>	370.0	372.0 <sup>(1)</sup>	309.0*	309.0 <sup>(1)</sup>	271.0*	272.0 <sup>(1)</sup>										
70	-	212.0	215.0 <sup>(1)</sup>	209.0*	209.0*	201.0*	201.0*	194.0*	194.0 <sup>(3)</sup>	188.0*	188.0*	182.0*	182.0*	177.0*	177.0*	172.0*	172.0 <sup>(1)</sup>	167.0*	167.0*						
70	B	405.0	496.0 <sup>(3)</sup>	437.0	490.0 <sup>(3)</sup>	421.0	488.0 <sup>(3)</sup>	393.0	405.0 <sup>(1)</sup>	363.0	370.0 <sup>(3)</sup>	309.0	309.0 <sup>(1)</sup>	270.0*	272.0 <sup>(1)</sup>	228.0*	229.0 <sup>(1)</sup>	192.0*	192.0*						
75	-	194.0	194.0	195.0*	195.0*	186.0*	186.0 <sup>(3)</sup>	181.0*	181.0*	175.0*	175.0*	170.0*	170.0*	165.0*	165.0*	160.0*	160.0*	152.0*	152.0*	151.0*	151.0*				
75	B	337.0	481.0 <sup>(3)</sup>	396.0	486.0 <sup>(3)</sup>	392.0	479.0 <sup>(1)</sup>	379.0	406.0 <sup>(1)</sup>	353.0	369.0 <sup>(1)</sup>	309.0	309.0 <sup>(1)</sup>	272.0	272.0	227.0*	229.0 <sup>(1)</sup>	191.0*	191.0 <sup>(1)</sup>	168.0*	168.0*				
80	-	176.0 <sup>(1)</sup>	180.0*	180.0*	174.0*	174.0*	169.0*	169.0*	163.0*	163.0*	159.0*	159.0*	154.0*	154.0*	150.0*	150.0*	145.0*	145.0*	141.0*	141.0 <sup>(1)</sup>	137.0*	137.0*			
80	B	464.0 <sup>(3)</sup>	362.0	470.0 <sup>(3)</sup>	359.0	469.0 <sup>(1)</sup>	358.0	403.0 <sup>(1)</sup>	339.0	367.0 <sup>(1)</sup>	307.0	309.0 <sup>(1)</sup>	270.0	270.0	229.0*	229.0 <sup>(1)</sup>	189.0*	191.0 <sup>(1)</sup>	166.0*	166.0 <sup>(1)</sup>	140.0*	140.0*			
85	-	158.0 <sup>(1)</sup>	166.0*	166.0 <sup>(1)</sup>	163.0*	163.0*	158.0*	158.0 <sup>(3)</sup>	153.0*	153.0*	149.0*	149.0*	144.0*	144.0*	140.0*	140.0 <sup>(3)</sup>	136.0*	136.0*	132.0*	132.0*	128.0*	128.0 <sup>(1)</sup>	117.0*	117.0*	
85	B	447.0 <sup>(3)</sup>	339.0	456.0 <sup>(2)</sup>	330.0	460.0 <sup>(1)</sup>	330.0	398.0 <sup>(1)</sup>	322.0	364.0 <sup>(1)</sup>	301.0	309.0 <sup>(1)</sup>	265.0	267.0 <sup>(1)</sup>	228.0	228.0 <sup>(1)</sup>	190.0	190.0 <sup>(1)</sup>	164.0*	165.0 <sup>(1)</sup>	139.0*	139.0 <sup>(1)</sup>	117.0*	117.0*	
90	-	144.0 <sup>(1)</sup>	154.0*	154.0*	151.0*	151.0*	149.0*	149.0*	143.0*	143.0*	139.0*	139.0*	135.0*	135.0*	132.0*	132.0*	128.0*	128.0*	124.0*	124.0*	121.0*	121.0*	115.0*	115.0*	
90	B	430.0 <sup>(3)</sup>	311.0	439.0 <sup>(3)</sup>	305.0	443.0 <sup>(1)</sup>	305.0	393.0 <sup>(1)</sup>	303.0	355.0 <sup>(1)</sup>	292.0	309.0 <sup>(1)</sup>	259.0	264.0 <sup>(1)</sup>	227.0	227.0 <sup>(1)</sup>	189.0	189.0 <sup>(1)</sup>	164.0	164.0	137.0*	138.0 <sup>(1)</sup>	115.0*	115.0 <sup>(1)</sup>	
95	-	130.0 <sup>(1)</sup>	141.0	141.0	141.0*	141.0*	139.0*	139.0*	135.0*	135.0*	131.0*	131.0*	127.0*	127.0 <sup>(3)</sup>	124.0*	124.0*	121.0*	121.0*	117.0*	117.0*	113.0*	113.0*	110.0*	110.0*	
95	B	412.0 <sup>(3)</sup>	274.0	420.0 <sup>(3)</sup>	289.0	423.0 <sup>(1)</sup>	284.0	388.0 <sup>(1)</sup>	282.0	347.0 <sup>(1)</sup>	277.0	305.0 <sup>(1)</sup>	250.0	262.0 <sup>(1)</sup>	225.0	225.0 <sup>(1)</sup>	187.0	187.0 <sup>(1)</sup>	161.0	161.0 <sup>(1)</sup>	137.0	137.0 <sup>(1)</sup>	114.0*	115.0 <sup>(1)</sup>	
100	-	120.0 <sup>(1)</sup>	128.0 <sup>(1)</sup>	128.0 <sup>(1)</sup>	132.0*	132.0*	130.0*	130.0*	127.0*	127.0*	124.0*	124.0*	120.0*	120.0*	117.0*	117.0*	114.0*	114.0*	110.0*	110.0 <sup>(1)</sup>	107.0*	107.0*	103.0*	103.0*	
100	B	395.0 <sup>(3)</sup>	401.0 <sup>(3)</sup>	269.0	403.0 <sup>(1)</sup>	265.0	376.0 <sup>(1)</sup>	263.0	338.0 <sup>(1)</sup>	262.0	300.0 <sup>(1)</sup>	242.0	259.0 <sup>(1)</sup>	224.0	224.0 <sup>(1)</sup>	185.0	186.0 <sup>(1)</sup>	158.0	159.0 <sup>(1)</sup>	136.0	136.0 <sup>(1)</sup>	114.0	114.0 <sup>(1)</sup>		
105	-	110.0 <sup>(1)</sup>	117.0 <sup>(1)</sup>	123.0*	123.0 <sup>(1)</sup>	122.0*	122.0*	119.0*	119.0*	117.0*	117.0*	114.0*	114.0*	111.0*	111.0*	107.0*	107.0*	104.0*	104.0*	101.0*	101.0 <sup>(1)</sup>	97.7*	97.7*		
105	B	377.0 <sup>(3)</sup>	382.0 <sup>(3)</sup>	251.0	383.0 <sup>(1)</sup>	248.0	362.0 <sup>(1)</sup>	246.0	329.0 <sup>(1)</sup>	246.0	295.0 <sup>(1)</sup>	233.0	254.0 <sup>(1)</sup>	221.0	223.0 <sup>(1)</sup>	183.0	185.0 <sup>(1)</sup>	156.0	157.0 <sup>(1)</sup>	135.0	135.0 <sup>(1)</sup>	113.0	113.0 <sup>(1)</sup>		
110	-	101.0 <sup>(1)</sup>	108.0 <sup>(1)</sup>	116.0*	116.0*	114.0*	114.0*	112.0*	112.0*	110.0*	110.0 <sup>(3)</sup>	108.0*	108.0*	105.0*	105.0*	102.0*	102.0 <sup>(3)</sup>	98.6*	98.6*	95.6*	95.6*	92.3*	92.3*		
110	B	360.0 <sup>(3)</sup>	363.0 <sup>(3)</sup>	235.0	363.0 <sup>(1)</sup>	233.0	349.0 <sup>(1)</sup>	231.0	319.0 <sup>(1)</sup>	231.0	290.0 <sup>(1)</sup>	224.0	249.0 <sup>(1)</sup>	217.0	221.0 <sup>(1)</sup>	182.0	183.0 <sup>(1)</sup>	153.0	155.0 <sup>(1)</sup>	134.0	134.0 <sup>(1)</sup>	111.0	112.0 <sup>(1)</sup>		
115	-	91.5 <sup>(1)</sup>	98.9 <sup>(1)</sup>	107.0	107.0	108.0*	108.0*	105.0*	105.0 <sup>(1)</sup>	104.0*	104.0*	102.0*	102.0*	99.5*	99.5*	96.5*	96.5*	93.4*	93.4*	90.5*	90.5*	87.5*	87.5*		
115	B	344.0 <sup>(3)</sup>	344.0 <sup>(3)</sup>	199.0	343.0 <sup>(1)</sup>	223.0	335.0 <sup>(1)</sup>	218.0	309.0 <sup>(1)</sup>	218.0	284.0 <sup>(1)</sup>	214.0	244.0 <sup>(1)</sup>	211.0	219.0 <sup>(1)</sup>	181.0	183.0 <sup>(1)</sup>	151.0	153.0 <sup>(1)</sup>	133.0	133.0 <sup>(1)</sup>	111.0	111.0 <sup>(1)</sup>		
120	-	83.6 <sup>(3)</sup>	91.6 <sup>(1)</sup>	97.1 <sup>(1)</sup>	97.1 <sup>(1)</sup>	102.0*	102.0*	99.3*	99.3*	97.6*	97.6*	95.7*	95.7*	94.2*	94.2*	91.6*	91.6*	88.6*	88.6*	85.8*	85.8*	82.8*	82.8*		
120	B	327.0 <sup>(3)</sup>	327.0 <sup>(3)</sup>	325.0 <sup>(3)</sup>	325.0 <sup>(3)</sup>	211.0	322.0 <sup>(1)</sup>	206.0	298.0 <sup>(1)</sup>	206.0	276.0 <sup>(1)</sup>	204.0	239.0 <sup>(1)</sup>	203.0	218.0 <sup>(1)</sup>	180.0	182.0 <sup>(1)</sup>	148.0	151.0 <sup>(1)</sup>	132.0	132.0 <sup>(1)</sup>	110.0	110.0 <sup>(1)</sup>		
125	-	77.1 <sup>(1)</sup>	84.8 <sup>(1)</sup>	89.4 <sup>(1)</sup>	89.4 <sup>(1)</sup>	96.1*	96.1*	93.8*	93.8*	92.2*	92.2*	90.2*	90.2*	89.0*	89.0*	87.0*	87.0*	84.2*	84.2*	81.5*	81.5*	78.6*	78.6*		
125	B	309.0 <sup>(3)</sup>	313.0 <sup>(3)</sup>	310.0 <sup>(3)</sup>	310.0 <sup>(3)</sup>	199.0	309.0 <sup>(1)</sup>	195.0	288.0 <sup>(1)</sup>	195.0	267.0 <sup>(1)</sup>	193.0	234.0 <sup>(1)</sup>	193.0	215.0 <sup>(1)</sup>	178.0	181.0 <sup>(1)</sup>	146.0	149.0 <sup>(1)</sup>	131.0	132.0 <sup>(1)</sup>	109.0	109.0 <sup>(1)</sup>		
130	-	70.7 <sup>(1)</sup>	78.0 <sup>(1)</sup>	82.8 <sup>(1)</sup>	82.8 <sup>(1)</sup>	91.2*	91.2*	88.8*	88.8*	87.2*	87.2*	85.2*	85.2*	84.0*	84.0 <sup>(3)</sup>	82.2*	82.2*	80.0*	80.0*	77.4*	77.4*	74.6*	74.6*		
130	B	292.0 <sup>(3)</sup>	301.0 <sup>(3)</sup>	296.0 <sup>(3)</sup>	296.0 <sup>(3)</sup>	186.0	295.0 <sup>(1)</sup>	188.0	277.0 <sup>(1)</sup>	185.0	259.0 <sup>(1)</sup>	183.0	229.0 <sup>(1)</sup>	183.0	213.0 <sup>(1)</sup>	175.0	181.0 <sup>(1)</sup>	143.0	147.0 <sup>(1)</sup>	130.0	131.0 <sup>(1)</sup>	108.0	108.0 <sup>(1)</sup>		
135	-	64.3 <sup>(3)</sup>	71.2 <sup>(1)</sup>	76.3 <sup>(1)</sup>	76.3 <sup>(1)</sup>	84.5	84.5	84.2*	84.2*	82.6*	82.6*	80.7*	80.7*	79.5*	79.5*	77.6*	77.6*	75.7*	75.7*	73.7*	73.7*	71.0*	71.0*		
135	B	274.0 <sup>(3)</sup>	289.0 <sup>(3)</sup>	285.0 <sup>(3)</sup>	285.0 <sup>(3)</sup>	160.0	282.0 <sup>(1)</sup>	180.0	267.0 <sup>(1)</sup>	176.0	250.0 <sup>(1)</sup>	174.0	223.0 <sup>(1)</sup>	174.0	209.0 <sup>(1)</sup>	169.0	179.0 <sup>(1)</sup>	141.0	146.0 <sup>(1)</sup>	130.0	130.0 <sup>(1)</sup>	107.0	108.0 <sup>(1)</sup>		
140	-	59.2 <sup>(3)</sup>	65.2 <sup>(3)</sup>	70.9 <sup>(1)</sup>	70.9 <sup>(1)</sup>	76.2 <sup>(1)</sup>	76.2 <sup>(1)</sup>	80.1*	80.1*	78.3*	78.3*	76.4*	76.4*	75.3*	75.3*	73.5*	73.5*	71.7*	71.7*	69.9*	69.9*	67.4*	67.4*		
140	B	257.0 <sup>(3)</sup>	275.0 <sup>(3)</sup>	272.0 <sup>(3)</sup>	272.0 <sup>(3)</sup>	170.0	270.0 <sup>(1)</sup>	170.0	257.0 <sup>(1)</sup>	170.0	242.0 <sup>(1)</sup>	166.0	218.0 <sup>(1)</sup>	165.0	204.0 <sup>(1)</sup>	164.0	177.0 <sup>(1)</sup>	138.0	144.0 <sup>(1)</sup>	129.0	130.0 <sup>(1)</sup>	106.0	107.0 <sup>(1)</sup>		
145	-	54.4 <sup>(3)</sup>	60.3 <sup>(3)</sup>	65.7 <sup>(1)</sup>	65.7 <sup>(1)</sup>	70.7 <sup>(1)</sup>	70.7 <sup>(1)</sup>	76.2*	76.2*	74.5*	74.5*	72.6*	72.6*	71.4*	71.4*	69.6*	69.6*	67.8*	67.8*	66.0*	66.0*	64.0*	64.0*		
145	B	242.0 <sup>(3)</sup>	260.0 <sup>(3)</sup>	259.0 <sup>(3)</sup>	259.0 <sup>(3)</sup>	161.0	246.0																		



# Lifting capacities Forces de levage

SDWB



60

		S 138																									
		W 59		W 79		W 98		W 118		W 138		W 157		W 177		W 197		W 217		W 236		W 256		W 276			
		85	Wmax	87*/85	Wmax	87*/85	Wmax	87*/85	Wmax	87*/85	Wmax	87*/85	Wmax	87*/85	Wmax	87*/85	Wmax	87*/85	Wmax	87*/85	Wmax	87*/85	Wmax	87*/85	Wmax		
38	-			372.0*	372.0*																						
40	-			354.0*	354.0*																						
45	-			315.0*	315.0*																						
50	-			284.0*	284.0*																						
55	-			248.0*	248.0*																						
60	-			227.0*	227.0*																						
65	-			203.0*	203.0*																						
70	-			188.0*	188.0*																						
75	-			169.0*	169.0*																						
80	-			148.0*	148.0*																						
85	-			127.0*	127.0*																						
90	-			107.0*	107.0*																						
95	-			88.2*	88.2*																						
100	-			70.9*	70.9*																						
105	-			55.8*	55.8*																						
110	-			43.4*	43.4*																						
115	-			33.9*	33.9*																						
120	-			26.7*	26.7*																						
125	-			21.0*	21.0*																						
130	-			16.4*	16.4*																						
135	-			12.8*	12.8*																						
140	-			9.8*	9.8*																						
145	-			7.5*	7.5*																						
150	-			5.9*	5.9*																						
155	-			4.7*	4.7*																						
160	-			3.9*	3.9*																						
165	-			3.2*	3.2*																						
170	-			2.7*	2.7*																						
175	-			2.3*	2.3*																						
180	-			2.0*	2.0*																						
185	-			1.8*	1.8*																						
190	-			1.6*	1.6*																						
195	-			1.5*	1.5*																						
200	-			1.4*	1.4*																						
205	-			1.3*	1.3*																						

1) 12°; 2) 17°; 3) 22°; 4) 27°; 5) 32°; 6) 37°; 7) 42°; 8) 47°; 9) 52°; 10) 57°; 11) 62°

# Lifting capacities Forces de levage

**SDWB**



286,600 lbs –  
374,800 lbs



529,100 lbs – 617,300 lbs  
330,700 lbs – 463,000 lbs  
66,100 lbs – 264,600 lbs



**60**

		S 138																									
		W 59		W 79		W 98		W 118		W 138		W 157		W 177		W 197		W 217		W 236		W 256		W 276			
		85	Wmax	87*/85	Wmax	87*/85	Wmax	87*/85	Wmax	87*/85	Wmax	87*/85	Wmax	87*/85	Wmax	87*/85	Wmax	87*/85	Wmax	87*/85	Wmax	87*/85	Wmax	87*/85	Wmax	87*/85	Wmax
210	- B						20.4 <sup>1)</sup>		23.9 <sup>2)</sup>		28.2 <sup>1)</sup>		31.1 <sup>1)</sup>	38.3*	38.3*	36.3*	36.3*	34.6*	34.6*	33.0*	33.0*	31.2*	31.2*				
	- B						160.0 <sup>2)</sup>		162.0 <sup>2)</sup>		158.0 <sup>1)</sup>		156.0 <sup>1)</sup>	93.9	151.0 <sup>1)</sup>	95.6	140.0 <sup>1)</sup>	94.2	115.0 <sup>2)</sup>	91.8	110.0 <sup>2)</sup>	90.3	95.1 <sup>1)</sup>				
215	- B						18.4 <sup>1)</sup>		21.6 <sup>2)</sup>		25.5 <sup>1)</sup>		28.4 <sup>1)</sup>	34.9	34.9	34.7*	34.7*	33.0*	33.0*	31.4*	31.4*	29.7*	29.7*				
	- B						16.4 <sup>1)</sup>		19.3 <sup>2)</sup>		22.8 <sup>1)</sup>		25.9 <sup>1)</sup>	29.2 <sup>1)</sup>	29.2 <sup>1)</sup>	33.2*	33.2*	31.5*	31.5*	29.9*	29.9*	28.2*	28.2*				
220	- B						145.0 <sup>2)</sup>		151.0 <sup>2)</sup>		149.0 <sup>2)</sup>		147.0 <sup>1)</sup>	84.4	147.0 <sup>1)</sup>	88.4	134.0 <sup>1)</sup>	88.3	112.0 <sup>2)</sup>	85.4	106.0 <sup>2)</sup>	83.7	93.8 <sup>2)</sup>				
	- B						17.0 <sup>2)</sup>		19.5 <sup>2)</sup>		23.7 <sup>1)</sup>		26.8 <sup>1)</sup>	31.9	31.9	30.1*	30.1*	28.4*	28.4*	26.7*	26.7*	25.4*	25.4*				
225	- B						148.0 <sup>2)</sup>		144.0 <sup>2)</sup>		143.0 <sup>2)</sup>		140.0 <sup>1)</sup>	84.7	131.0 <sup>1)</sup>	85.0	110.0 <sup>2)</sup>	83.4	104.0 <sup>2)</sup>	80.8	93.1 <sup>1)</sup>	80.8	93.1 <sup>1)</sup>				
	- B						14.5 <sup>1)</sup>		17.7 <sup>2)</sup>		21.6 <sup>1)</sup>		24.5 <sup>1)</sup>	30.6*	30.6*	28.8*	28.8*	27.1*	27.1*	25.4*	25.4*	24.1*	24.1*				
230	- B						140.0 <sup>1)</sup>		140.0 <sup>2)</sup>		139.0 <sup>2)</sup>		136.0 <sup>1)</sup>	80.6	128.0 <sup>1)</sup>	81.3	108.0 <sup>2)</sup>	81.3	103.0 <sup>2)</sup>	77.9	92.4 <sup>2)</sup>	77.9	92.4 <sup>2)</sup>				
	- B						12.7 <sup>1)</sup>		15.8 <sup>2)</sup>		19.4 <sup>1)</sup>		22.1 <sup>1)</sup>	27.7	27.7	27.5*	27.5*	25.8*	25.8*	24.1*	24.1*	22.8*	22.8*				
235	- B						134.0 <sup>2)</sup>		135.0 <sup>2)</sup>		134.0 <sup>2)</sup>		133.0 <sup>1)</sup>	72.2	125.0 <sup>1)</sup>	78.7	107.0 <sup>2)</sup>	78.5	102.0 <sup>2)</sup>	75.3	90.8 <sup>2)</sup>	75.3	90.8 <sup>2)</sup>				
	- B						10.9 <sup>1)</sup>		14.0 <sup>2)</sup>		17.2 <sup>1)</sup>		20.1 <sup>1)</sup>	20.1 <sup>1)</sup>	22.2 <sup>1)</sup>	26.3*	26.3*	24.5*	24.5*	22.8*	22.8*	21.5*	21.5*				
240	- B						127.0 <sup>2)</sup>		130.0 <sup>2)</sup>		129.0 <sup>2)</sup>		128.0 <sup>1)</sup>		122.0 <sup>1)</sup>	75.7	105.0 <sup>2)</sup>	75.7	101.0 <sup>2)</sup>	73.7	89.1 <sup>1)</sup>	73.7	89.1 <sup>1)</sup>				
	- B						12.1 <sup>1)</sup>		14.3 <sup>2)</sup>		18.4 <sup>1)</sup>		20.4 <sup>1)</sup>		25.2*	25.2*	23.4*	23.4*	21.8*	21.8*	20.5*	20.5*					
245	- B						126.0 <sup>2)</sup>		124.0 <sup>2)</sup>		124.0 <sup>1)</sup>		119.0 <sup>1)</sup>		119.0 <sup>1)</sup>	72.5	104.0 <sup>2)</sup>	73.0	98.9 <sup>2)</sup>	72.1	87.3 <sup>2)</sup>	72.1	87.3 <sup>2)</sup>				
	- B						9.5 <sup>1)</sup>		12.6 <sup>2)</sup>		16.6 <sup>1)</sup>		18.6 <sup>1)</sup>		24.3*	24.3*	22.2*	22.2*	20.8*	20.8*	19.5*	19.5*					
250	- B						120.0 <sup>2)</sup>		120.0 <sup>2)</sup>		120.0 <sup>1)</sup>		116.0 <sup>1)</sup>		116.0 <sup>1)</sup>	69.1	102.0 <sup>2)</sup>	70.3	97.1 <sup>2)</sup>	69.6	86.0 <sup>2)</sup>	69.6	86.0 <sup>2)</sup>				
	- B						7.7 <sup>1)</sup>		11.0 <sup>2)</sup>		14.8 <sup>1)</sup>		16.8 <sup>1)</sup>		21.7*	21.7*	21.3*	21.3*	19.9*	19.9*	18.6*	18.6*					
255	- B						116.0 <sup>2)</sup>		116.0 <sup>2)</sup>		116.0 <sup>1)</sup>		113.0 <sup>1)</sup>		113.0 <sup>1)</sup>	61.7	100.0 <sup>2)</sup>	67.8	95.4 <sup>2)</sup>	67.2	84.9 <sup>2)</sup>	67.2	84.9 <sup>2)</sup>				
	- B						9.3 <sup>2)</sup>		9.3 <sup>2)</sup>		13.0 <sup>1)</sup>		15.2 <sup>1)</sup>		17.2 <sup>1)</sup>		17.2 <sup>1)</sup>	20.5*	20.5*	19.0*	19.0*	17.7*	17.7*				
260	- B						111.0 <sup>2)</sup>		112.0 <sup>2)</sup>		112.0 <sup>1)</sup>		110.0 <sup>1)</sup>		110.0 <sup>1)</sup>	65.2	98.8 <sup>2)</sup>	65.2	93.6 <sup>2)</sup>	64.7	83.7 <sup>2)</sup>	64.7	83.7 <sup>2)</sup>				
	- B						11.9 <sup>1)</sup>		13.5 <sup>1)</sup>		18.4 <sup>1)</sup>		20.4 <sup>1)</sup>		25.2*	25.2*	23.4*	23.4*	21.8*	21.8*	20.5*	20.5*					
265	- B						108.0 <sup>2)</sup>		108.0 <sup>2)</sup>		108.0 <sup>1)</sup>		107.0 <sup>1)</sup>		107.0 <sup>1)</sup>		97.2 <sup>2)</sup>	62.2	91.9 <sup>2)</sup>	62.4	82.6 <sup>2)</sup>	62.4	82.6 <sup>2)</sup>				
	- B						10.8 <sup>1)</sup>		12.4 <sup>2)</sup>		16.6 <sup>1)</sup>		18.6 <sup>1)</sup>		24.3*	24.3*	22.2*	22.2*	20.8*	20.8*	19.5*	19.5*					
270	- B						105.0 <sup>2)</sup>		105.0 <sup>2)</sup>		105.0 <sup>1)</sup>		103.0 <sup>1)</sup>		103.0 <sup>1)</sup>		95.7 <sup>2)</sup>	59.0	90.2 <sup>2)</sup>	60.1	81.5 <sup>2)</sup>	60.1	81.5 <sup>2)</sup>				
	- B						9.9 <sup>1)</sup>		11.9 <sup>2)</sup>		15.8 <sup>1)</sup>		17.8 <sup>1)</sup>		21.7*	21.7*	21.3*	21.3*	19.9*	19.9*	18.6*	18.6*					
275	- B						102.0 <sup>2)</sup>		102.0 <sup>2)</sup>		102.0 <sup>1)</sup>		101.0 <sup>1)</sup>		101.0 <sup>1)</sup>		94.1 <sup>2)</sup>	51.9	88.5 <sup>2)</sup>	58.0	80.0 <sup>2)</sup>	58.0	80.0 <sup>2)</sup>				
	- B						9.9 <sup>2)</sup>		9.9 <sup>2)</sup>		13.0 <sup>1)</sup>		15.2 <sup>1)</sup>		17.2 <sup>1)</sup>		17.2 <sup>1)</sup>	20.5*	20.5*	19.0*	19.0*	17.7*	17.7*				
280	- B						99.2 <sup>2)</sup>		98.8 <sup>2)</sup>		98.8 <sup>1)</sup>		98.0 <sup>1)</sup>		98.0 <sup>1)</sup>		92.2 <sup>2)</sup>		86.8 <sup>2)</sup>	55.7	78.9 <sup>2)</sup>	55.7	78.9 <sup>2)</sup>				
	- B						9.6 <sup>1)</sup>		11.6 <sup>2)</sup>		15.5 <sup>1)</sup>		17.5 <sup>1)</sup>		21.5*	21.5*	21.1*	21.1*	19.7*	19.7*	18.4*	18.4*					
285	- B						96.1 <sup>2)</sup>		95.0 <sup>2)</sup>		95.0 <sup>1)</sup>		93.0 <sup>1)</sup>		93.0 <sup>1)</sup>		87.2 <sup>2)</sup>		81.2 <sup>2)</sup>	53.2	77.8 <sup>2)</sup>	53.2	77.8 <sup>2)</sup>				
	- B						9.3 <sup>2)</sup>		11.3 <sup>2)</sup>		15.2 <sup>1)</sup>		17.2 <sup>1)</sup>		21.2*	21.2*	20.8*	20.8*	19.4*	19.4*	18.1*	18.1*					
290	- B						93.6 <sup>2)</sup>		92.5 <sup>2)</sup>		92.5 <sup>1)</sup>		90.5 <sup>1)</sup>		90.5 <sup>1)</sup>		84.7 <sup>2)</sup>		78.7 <sup>2)</sup>	49.8	76.6 <sup>2)</sup>	49.8	76.6 <sup>2)</sup>				
	- B						9.1 <sup>1)</sup>		11.1 <sup>2)</sup>		15.0 <sup>1)</sup>		17.0 <sup>1)</sup>		21.0*	21.0*	20.6*	20.6*	19.2*	19.2*	17.9*	17.9*					
295	- B						91.2 <sup>2)</sup>		91.2 <sup>2)</sup>		91.2 <sup>1)</sup>		89.2 <sup>1)</sup>		89.2 <sup>1)</sup>		83.4 <sup>2)</sup>		77.4 <sup>2)</sup>	43.3	75.5 <sup>2)</sup>	43.3	75.5 <sup>2)</sup>				
	- B						8.8 <sup>1)</sup>		10.8 <sup>2)</sup>		14.7 <sup>1)</sup>		16.7 <sup>1)</sup>		20.7*	20.7*	20.3*	20.3*	18.9*	18.9*	17.6*	17.6*					
300	- B						89.2 <sup>2)</sup>		87.6 <sup>2)</sup>		87.6 <sup>1)</sup>		85.6 <sup>1)</sup>		85.6 <sup>1)</sup>		79.8 <sup>2)</sup>		73.8 <sup>2)</sup>	43.3	75.5 <sup>2)</sup>	43.3	75.5 <sup>2)</sup>				
	- B						8.4 <sup>1)</sup>		10.4 <sup>2)</sup>		14.3 <sup>1)</sup>		16.3 <sup>1)</sup>		20.3*	20.3*	20.0*	20.0*	18.6*	18.6*	17.3*	17.3*					
305	- B						85.6 <sup>2)</sup>		85.6 <sup>2)</sup>		85.6 <sup>1)</sup>		83.6 <sup>1)</sup>		83.6 <sup>1)</sup>		77.8 <sup>2)</sup>		71.8 <sup>2)</sup>	43.3	75.5 <sup>2)</sup>	43.3	75.5 <sup>2)</sup>				
	- B						8.1 <sup>1)</sup>		10.1 <sup>2)</sup>		14.0 <sup>1)</sup>		16.0 <sup>1)</sup>		20.0*	20.0*	19.7*	19.7*	18.4*	18.4*	17.1*	17.1*					
310	- B						83.3 <sup>2)</sup>		83.3 <sup>2)</sup>		83.3 <sup>1)</sup>		81.3 <sup>1)</sup>		81.3 <sup>1)</sup>		75.5 <sup>2)</sup>		69.5 <sup>2)</sup>	43.3	75.5 <sup>2)</sup>	43.3	75.5 <sup>2)</sup>				
	- B						7.7 <sup>1)</sup>		9.7 <sup>2)</sup>		13.6 <sup>1)</sup>		15.6 <sup>1)</sup>		19.6*	19.6*	19.3*	19.3*	18.0*	18.0*	16.7*	16.7*					
315	- B						81.5 <sup>2)</sup>		81.5 <sup>2)</sup>		81.5 <sup>1)</sup>		79.5 <sup>1)</sup>		79.5 <sup>1)</sup>		73.7 <sup>2)</sup>		67.7 <sup>2)</sup>	43.3	75.5 <sup>2)</sup>	43.3	75.5 <sup>2)</sup>				
	- B						7.4 <sup>1)</sup>		9.4 <sup>2)</sup>		13.3 <sup>1)</sup>		15.3 <sup>1)</sup>		19.3*	19.3*	19.0*	19.0*	17.7*	17.7*	16.4*	16.4*					
320	- B						77.9 <sup>2)</sup>		77.9 <sup>2)</sup>		77.9 <sup>1)</sup>		75.9 <sup>1)</sup>		75.9 <sup>1)</sup>		70.1 <sup>2)</sup>		64.1 <sup>2)</sup>	43.3	75.5 <sup>2)</sup>	43.3	75.5 <sup>2)</sup>				
	- B						7.1 <sup>1)</sup>		9.1 <sup>2)</sup>		13.0 <sup>1)</sup>		15.0 <sup>1)</sup>		19.0*	19.0*	18.7*	18.7*	17.4*	17.4*	16.1*	16.1*					
325	- B						74.9 <sup>2)</sup>		74.9 <sup>2)</sup>		74.9 <sup>1)</sup>		72.9 <sup>1)</sup>		72.9 <sup>1)</sup>		67.1 <sup>2)</sup>		61.1 <sup>2)</sup>	43.3	75.5 <sup>2)</sup>	43.3	75.5 <sup>2)</sup>				
	- B						6.8 <sup>1)</sup>		8.8 <sup>2)</sup>		12.7 <sup>1)</sup>		14.7 <sup>1)</sup>		18.7*	18.7*	18.4*	18.4*	17.1*	17.1*	15.8*	15.8*					
330	- B						72.6 <sup>2)</sup>		72.6 <sup>2)</sup>		72.6 <sup>1)</sup>		70.6 <sup>1)</sup>		70.6 <sup>1)</sup>		64.8 <sup>2)</sup>		58.8 <sup>2)</sup>	43.3	75.5 <sup>2)</sup>	43.3	75.5 <sup>2)</sup>				
	- B						6.5 <sup>1)</sup>		8.5 <sup>2)</sup>		12.4 <sup>1)</sup>		14.4 <sup>1)</sup>		18.4*	18.4*	18.1*	18.1*	16.8*	16.8*	15.5*	15.5*					
335	- B						70.5 <sup>2)</sup>		70.5 <sup>2)</sup>	</																	

# Lifting capacities Forces de levage

SDWB



286,600 lbs -  
374,800 lbs



529,100 lbs - 617,300 lbs  
330,700 lbs - 463,000 lbs  
66,100 lbs - 264,600 lbs



60

		S 157																							
		W 59		W 79		W 98		W 118		W 138		W 157		W 177		W 197		W 217		W 236		W 256		W 276	
		85	Wmax	87*/85	Wmax	87*/85	Wmax	87*/85	Wmax	87*/85	Wmax	87*/85	Wmax	87*/85	Wmax	87*/85	Wmax	87*/85	Wmax	87*/85	Wmax	87*/85	Wmax	87*/85	Wmax
40	-			339.0*	339.0 <sup>(1)</sup>																				
40	B			442.0*	442.0 <sup>(1)</sup>																				
45	-	305.0	314.0 <sup>(2)</sup>	303.0*	303.0*	291.0*	291.0*																		
45	B	551.0	551.0	437.0*	445.0 <sup>(1)</sup>	419.0*	419.0*																		
50	-	275.0	282.0 <sup>(2)</sup>	274.0*	274.0*	263.0*	263.0*	255.0*	255.0*																
50	B	537.0	551.0 <sup>(1)</sup>	446.0	447.0 <sup>(1)</sup>	411.0*	419.0 <sup>(1)</sup>	346.0*	346.0*																
55	-	250.0	256.0 <sup>(2)</sup>	249.0*	249.0*	240.0*	240.0*	232.0*	232.0*	224.0*	224.0*														
55	B	509.0	551.0 <sup>(1)</sup>	442.0	449.0 <sup>(1)</sup>	419.0	419.0 <sup>(1)</sup>	346.0*	346.0 <sup>(1)</sup>	309.0*	309.0*														
60	-	229.0	234.0 <sup>(2)</sup>	228.0*	228.0*	220.0*	220.0*	213.0*	213.0*	206.0*	206.0*	199.0*	199.0*												
60	B	485.0	551.0 <sup>(1)</sup>	439.0	450.0 <sup>(1)</sup>	411.0	419.0 <sup>(1)</sup>	346.0	346.0 <sup>(1)</sup>	308.0*	309.0 <sup>(1)</sup>	272.0*	272.0*												
65	-	211.0	217.0 <sup>(2)</sup>	211.0*	211.0*	203.0*	203.0*	197.0*	197.0*	190.0*	190.0*	184.0*	184.0*	179.0*	179.0*										
65	B	458.0	539.0 <sup>(1)</sup>	429.0	451.0 <sup>(1)</sup>	397.0	419.0 <sup>(1)</sup>	346.0	346.0 <sup>(1)</sup>	309.0	309.0 <sup>(1)</sup>	270.0*	272.0 <sup>(1)</sup>	234.0*	234.0*										
70	-	196.0	202.0 <sup>(2)</sup>	196.0*	196.0*	188.0*	188.0*	183.0*	183.0*	177.0*	177.0*	171.0*	171.0*	166.0*	166.0*	162.0*	162.0*								
70	B	424.0	521.0 <sup>(1)</sup>	410.0	451.0 <sup>(1)</sup>	382.0	419.0 <sup>(1)</sup>	344.0	346.0 <sup>(1)</sup>	309.0	309.0 <sup>(1)</sup>	272.0	272.0 <sup>(1)</sup>	234.0*	234.0 <sup>(1)</sup>	196.0*	196.0 <sup>(1)</sup>								
75	-	182.0	185.0 <sup>(2)</sup>	182.0*	182.0*	175.0*	175.0*	170.0*	170.0*	165.0*	165.0*	160.0*	160.0*	155.0*	155.0*	151.0*	151.0*	145.0*	145.0*						
75	B	381.0	502.0 <sup>(1)</sup>	395.0	453.0 <sup>(1)</sup>	368.0	419.0 <sup>(1)</sup>	339.0	346.0 <sup>(1)</sup>	308.0	309.0 <sup>(1)</sup>	272.0	272.0	234.0	234.0 <sup>(1)</sup>	196.0*	196.0 <sup>(1)</sup>	171.0*	171.0*						
80	-	172.0	172.0 <sup>(2)</sup>	171.0*	171.0*	164.0*	164.0*	159.0*	159.0*	154.0*	154.0*	149.0*	149.0*	145.0*	145.0*	141.0*	141.0*	136.0*	136.0*	132.0*	132.0*				
80	B	295.0	483.0 <sup>(1)</sup>	378.0	454.0 <sup>(1)</sup>	354.0	414.0 <sup>(1)</sup>	329.0	346.0 <sup>(1)</sup>	309.0	309.0 <sup>(1)</sup>	274.0	308.0 <sup>(1)</sup>	254.0	268.0 <sup>(1)</sup>	226.0	230.0 <sup>(1)</sup>	196.0	196.0 <sup>(1)</sup>	170.0*	171.0 <sup>(1)</sup>	132.0*	132.0*		
85	-		155.0 <sup>(1)</sup>	161.0*	161.0*	154.0*	154.0*	149.0*	149.0*	144.0*	144.0*	140.0*	140.0*	136.0*	136.0*	132.0*	132.0*	128.0*	128.0*	124.0*	124.0*	120.0*	120.0*		
85	B		463.0*	361.0	445.0 <sup>(1)</sup>	340.0	411.0 <sup>(1)</sup>	316.0	346.0 <sup>(1)</sup>	294.0	309.0 <sup>(1)</sup>	266.0	270.0 <sup>(1)</sup>	233.0	233.0 <sup>(1)</sup>	196.0	196.0 <sup>(1)</sup>	171.0	171.0 <sup>(1)</sup>	146.0*	147.0 <sup>(1)</sup>	126.0*	126.0*		
90	-		140.0 <sup>(1)</sup>	151.0*	151.0*	145.0*	145.0*	141.0*	141.0*	136.0*	136.0*	132.0*	132.0*	128.0*	128.0*	125.0*	125.0*	120.0*	120.0*	116.0*	116.0*	113.0*	113.0*	105.0*	105.0*
90	B		441.0*	337.0	436.0 <sup>(1)</sup>	326.0	404.0 <sup>(1)</sup>	304.0	346.0 <sup>(1)</sup>	284.0	309.0 <sup>(1)</sup>	261.0	269.0 <sup>(1)</sup>	230.0	231.0 <sup>(1)</sup>	196.0	196.0 <sup>(1)</sup>	170.0	170.0 <sup>(1)</sup>	144.0*	146.0 <sup>(1)</sup>	124.0*	125.0 <sup>(1)</sup>	105.0*	105.0*
95	-		127.0 <sup>(1)</sup>	136.0	137.0 <sup>(1)</sup>	137.0*	137.0*	133.0*	133.0*	128.0*	128.0*	124.0*	124.0*	120.0*	120.0*	117.0*	117.0*	113.0*	113.0*	109.0*	109.0*	106.0*	106.0*	102.0*	102.0*
95	B		420.0*	305.0	417.0 <sup>(1)</sup>	312.0	398.0 <sup>(1)</sup>	293.0	346.0 <sup>(1)</sup>	293.0	308.0 <sup>(1)</sup>	254.0	268.0 <sup>(1)</sup>	226.0	230.0 <sup>(1)</sup>	196.0	196.0 <sup>(1)</sup>	168.0	169.0 <sup>(1)</sup>	145.0	145.0 <sup>(1)</sup>	123.0*	124.0 <sup>(1)</sup>	104.0*	104.0 <sup>(1)</sup>
100	-		116.0 <sup>(1)</sup>	127.0	127.0	129.0*	129.0*	126.0*	126.0*	121.0*	121.0*	117.0*	117.0*	114.0*	114.0*	111.0*	111.0*	106.0*	106.0*	103.0*	103.0*	100.0*	100.0*	96.5*	96.5*
100	B		400.0*	238.0	398.0 <sup>(1)</sup>	296.0	386.0 <sup>(1)</sup>	283.0	346.0 <sup>(1)</sup>	264.0	307.0 <sup>(1)</sup>	246.0	267.0 <sup>(1)</sup>	221.0	229.0 <sup>(1)</sup>	196.0	196.0 <sup>(1)</sup>	167.0	168.0 <sup>(1)</sup>	143.0	144.0 <sup>(1)</sup>	123.0	123.0 <sup>(1)</sup>	103.0*	104.0 <sup>(1)</sup>
105	-		105.0 <sup>(1)</sup>		115.0 <sup>(1)</sup>	121.0*	121.0*	119.0*	119.0*	115.0*	115.0*	111.0*	111.0*	107.0*	107.0*	105.0*	105.0*	101.0*	101.0*	97.5*	97.5*	94.4*	94.4*	91.1*	91.1*
105	B		380.0*		379.0 <sup>(1)</sup>	282.0	371.0 <sup>(1)</sup>	273.0	346.0 <sup>(1)</sup>	256.0	306.0 <sup>(1)</sup>	239.0	265.0 <sup>(1)</sup>	216.0	228.0 <sup>(1)</sup>	195.0	196.0 <sup>(1)</sup>	166.0	167.0 <sup>(1)</sup>	141.0	142.0 <sup>(1)</sup>	123.0	123.0 <sup>(1)</sup>	103.0	103.0 <sup>(1)</sup>
110	-		96.3 <sup>(1)</sup>		105.0 <sup>(1)</sup>	113.0*	113.0*	112.0*	112.0*	109.0*	109.0*	105.0*	105.0*	102.0*	102.0*	99.4*	99.4*	95.4*	95.4*	92.2*	92.2*	89.4*	89.4*	86.1*	86.1*
110	B		361.0*		361.0 <sup>(1)</sup>	262.0	355.0 <sup>(1)</sup>	262.0	340.0 <sup>(1)</sup>	249.0	304.0 <sup>(1)</sup>	233.0	265.0 <sup>(1)</sup>	210.0	226.0 <sup>(1)</sup>	194.0	196.0 <sup>(1)</sup>	165.0	166.0 <sup>(1)</sup>	139.0	141.0 <sup>(1)</sup>	122.0	122.0 <sup>(1)</sup>	102.0	102.0 <sup>(1)</sup>
115	-		89.1 <sup>(1)</sup>		96.4 <sup>(1)</sup>	103.0	103.0 <sup>(1)</sup>	105.0*	105.0*	103.0*	103.0*	99.9*	99.9*	96.7*	96.7*	94.3*	94.3*	90.4*	90.4*	87.3*	87.3*	84.5*	84.5*	81.5*	81.5*
115	B		343.0*		344.0 <sup>(1)</sup>	232.0	340.0 <sup>(1)</sup>	247.0	333.0 <sup>(1)</sup>	241.0	302.0 <sup>(1)</sup>	226.0	263.0 <sup>(1)</sup>	204.0	223.0 <sup>(1)</sup>	192.0	196.0 <sup>(1)</sup>	163.0	165.0 <sup>(1)</sup>	137.0	140.0 <sup>(1)</sup>	121.0	121.0 <sup>(1)</sup>	101.0	102.0 <sup>(1)</sup>
120	-		81.8 <sup>(1)</sup>		88.7 <sup>(1)</sup>		95.5 <sup>(1)</sup>	99.5*	99.5*	97.4*	97.4*	95.1*	95.1*	91.9*	91.9*	89.7*	89.7*	85.8*	85.8*	82.9*	82.9*	80.2*	80.2*	77.3*	77.3*
120	B		326.0*		328.0 <sup>(1)</sup>		326.0 <sup>(1)</sup>	237.0	321.0 <sup>(1)</sup>	230.0	299.0 <sup>(1)</sup>	220.0	262.0 <sup>(1)</sup>	197.0	220.0 <sup>(1)</sup>	189.0	196.0 <sup>(1)</sup>	163.0	165.0 <sup>(1)</sup>	136.0	139.0 <sup>(1)</sup>	120.0	121.0 <sup>(1)</sup>	101.0	101.0 <sup>(1)</sup>
125	-		74.6 <sup>(1)</sup>		80.9 <sup>(1)</sup>		87.9 <sup>(1)</sup>	94.1*	94.1*	92.0*	92.0*	89.9*	89.9*	87.5*	87.5*	85.3*	85.3*	81.6*	81.6*	78.7*	78.7*	76.1*	76.1*	73.3*	73.3*
125	B		310.0*		314.0 <sup>(1)</sup>		312.0 <sup>(1)</sup>	223.0	309.0 <sup>(1)</sup>	219.0	297.0 <sup>(1)</sup>	214.0	260.0 <sup>(1)</sup>	191.0	218.0 <sup>(1)</sup>	186.0	196.0 <sup>(1)</sup>	161.0	164.0 <sup>(1)</sup>	134.0	137.0 <sup>(1)</sup>	120.0	120.0 <sup>(1)</sup>	100.0	100.0 <sup>(1)</sup>
130	-		67.3 <sup>(1)</sup>		74.8 <sup>(1)</sup>		80.3 <sup>(1)</sup>	89.2*	89.2*	87.0*	87.0*	85.0*	85.0*	83.2*	83.2*	81.3*	81.3*	77.7*	77.7*	74.8*	74.8*	72.3*	72.3*	69.5*	69.5*
130	B		295.0*		300.0 <sup>(1)</sup>		299.0 <sup>(1)</sup>	207.0	297.0 <sup>(1)</sup>	208.0	288.0 <sup>(1)</sup>	206.0	258.0 <sup>(1)</sup>	186.0	215.0 <sup>(1)</sup>	182.0	195.0 <sup>(1)</sup>	160.0	164.0 <sup>(1)</sup>	132.0	136.0 <sup>(1)</sup>	119.0	119.0 <sup>(1)</sup>	99.4	99.6 <sup>(1)</sup>
135	-		60.5 <sup>(1)</sup>		69.2 <sup>(1)</sup>		74.3 <sup>(1)</sup>	81.7	81.7	82.5*	82.5*	80.5*	80.5*	78.7*	78.7*	77.5*	77.5*	74.0*	74.0*	71.3*	71.3*	68.8*	68.8*	66.1*	66.1*
135	B		281.0*		288.0 <sup>(1)</sup>		286.0 <sup>(1)</sup>	185.0	285.0 <sup>(1)</sup>	201.0	278.0 <sup>(1)</sup>	196.0	256.0 <sup>(1)</sup>	180.0	212.0 <sup>(1)</sup>	178.0	194.0 <sup>(1)</sup>	159.0	164.0 <sup>(1)</sup>	130.0	134.0 <sup>(1)</sup>	118.0	119.0 <sup>(1)</sup>	98.7	99.0 <sup>(1)</sup>
140	-		55.7 <sup>(1)</sup>		63.7 <sup>(1)</sup>		68.5 <sup>(1)</sup>		74.9 <sup>(1)</sup>	78.4*	78.4*	76.4*	76.4*	74.6*	74.6*	73.4*	73.4*	70.6*	70.6*	67.9*	67.9*	65.4*	65.4*	62.8*	62.8*
140	B		269.0*		275.0 <sup>(1)</sup>		273.0 <sup>(1)</sup>		273.0 <sup>(1)</sup>	191.0	268.0 <sup>(1)</sup>	188.0	250.0 <sup>(1)</sup>	174.0	209.0 <sup>(1)</sup>	174.0	192.0 <sup>(1)</sup>	158.0	163.0 <sup>(1)</sup>	128.0	133.0 <sup>(1)</sup>	117.0	118.0 <sup>(1)</sup>	98.0	98.6 <sup>(1)</sup>
145	-		51.0 <sup>(1)</sup>		58.2 <sup>(1)</sup>		62.6 <sup>(1)</sup>		69.0 <sup>(1)</sup>	74.5*	74.5*	72.5*	72.5*	70.7*	70.7*	69.6*	69.6*	67.1*	67.1*	64.7*	64.7*	62.4*	62.4*	59.8*	59.8*
145	B		258.0*		263.0 <sup>(1)</sup>		264.0 <sup>(1)</sup>		263.0 <sup>(1)</sup>	181.0	259.0 <sup>(1)</sup>	181.0	243.0 <sup>(1)</sup>	169.0	206.0 <sup>(1)</sup>	170.0	191.0 <sup>(1)</sup>	156.0	163.0 <sup>(1)</sup>	126.0	133.0 <sup>(1)</sup>	116.0	118.0 <sup>(1)</sup>	97.3	98.2 <sup>(1)</sup>
150	-		46.3 <sup>(1)</sup>		52.6 <sup>(1)</sup>		58.0 <sup>(1)</sup>		63.5 <sup>(1)</sup>	71.0*	71.0*	69.0*	69.0*	67.2*	67.2*	66.0*	66.0*	63.6*	63.6*	61.7*	61.7*	59.5*	59.5*	56.9*	56.9*
150	B		247.0*		251.0 <sup>(1)</sup>		252.0 <sup>(1)</sup>		252.0 <sup>(1)</sup>	167.0	249.0 <sup>(1)</sup>	173.0	236.0 <sup>(1)</sup>	163.0	203.0 <sup>(1)</sup>	165.0	189.0 <sup>(1)</sup>								

# Lifting capacities Forces de levage

**SDWB**

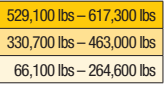

**60**

		S 157																									
		W 59		W 79		W 98		W 118		W 138		W 157		W 177		W 197		W 217		W 236		W 256		W 276			
		85	Wmax	87*/85	Wmax	87*/85	Wmax	87*/85	Wmax	87*/85	Wmax	87*/85	Wmax	87*/85	Wmax	87*/85	Wmax	87*/85	Wmax	87*/85	Wmax	87*/85	Wmax	87*/85	Wmax	87*/85	Wmax
220	- B						15.1 <sup>(1)</sup>	18.3 <sup>(2)</sup>	22.6 <sup>(1)</sup>	25.1 <sup>(1)</sup>	28.9 <sup>(1)</sup>	32.4*	32.4*	30.7*	30.7*	29.1*	29.1*	27.4*	27.4*								
	- B						151.0 <sup>(1)</sup>	154.0 <sup>(2)</sup>	153.0 <sup>(1)</sup>	151.0 <sup>(2)</sup>	149.0 <sup>(2)</sup>	92.1	140.0 <sup>(1)</sup>	89.9	112.0 <sup>(2)</sup>	92.7	108.0 <sup>(2)</sup>	87.2	92.3 <sup>(2)</sup>								
225	- B						13.2 <sup>(1)</sup>	16.3 <sup>(2)</sup>	20.1 <sup>(1)</sup>	22.8 <sup>(1)</sup>	26.3 <sup>(1)</sup>	31.1*	31.1*	29.3*	29.3*	27.7*	27.7*	25.9*	25.9*								
	- B						145.0 <sup>(1)</sup>	149.0 <sup>(2)</sup>	148.0 <sup>(1)</sup>	146.0 <sup>(2)</sup>	145.0 <sup>(2)</sup>	86.2	138.0 <sup>(1)</sup>	87.5	110.0 <sup>(2)</sup>	90.5	107.0 <sup>(2)</sup>	85.7	91.9 <sup>(2)</sup>								
230	- B						11.3 <sup>(1)</sup>	14.3 <sup>(2)</sup>	17.7 <sup>(1)</sup>	20.8 <sup>(1)</sup>	24.1 <sup>(1)</sup>	29.8*	29.8*	28.0*	28.0*	26.3*	26.3*	24.6*	24.6*								
	- B						139.0 <sup>(1)</sup>	144.0 <sup>(2)</sup>	143.0 <sup>(1)</sup>	142.0 <sup>(2)</sup>	141.0 <sup>(2)</sup>	79.8	134.0 <sup>(1)</sup>	85.0	109.0 <sup>(2)</sup>	88.6	105.0 <sup>(2)</sup>	83.7	91.5 <sup>(2)</sup>								
235	- B						9.4 <sup>(1)</sup>	12.4 <sup>(2)</sup>	14.7 <sup>(1)</sup>	18.8 <sup>(1)</sup>	21.9 <sup>(1)</sup>	26.6	26.6	26.7*	26.7*	25.0*	25.0*	23.3*	23.3*								
	- B						133.0 <sup>(1)</sup>	140.0 <sup>(2)</sup>	139.0 <sup>(1)</sup>	137.0 <sup>(2)</sup>	137.0 <sup>(2)</sup>	71.6	131.0 <sup>(1)</sup>	81.6	107.0 <sup>(2)</sup>	85.4	103.0 <sup>(2)</sup>	81.7	91.0 <sup>(2)</sup>								
240	- B						12.9 <sup>(1)</sup>	16.8 <sup>(2)</sup>	19.7 <sup>(1)</sup>	21.6 <sup>(1)</sup>	25.5*	25.5*	23.8*	23.8*	22.1*	22.1*	20.2*	20.2*									
	- B							133.0 <sup>(1)</sup>	134.0 <sup>(2)</sup>	133.0 <sup>(2)</sup>	133.0 <sup>(2)</sup>		128.0 <sup>(1)</sup>	77.7	106.0 <sup>(2)</sup>	82.0	102.0 <sup>(2)</sup>	79.8	90.1 <sup>(2)</sup>								
245	- B						11.0 <sup>(1)</sup>	14.7 <sup>(2)</sup>	17.8 <sup>(1)</sup>	20.8 <sup>(1)</sup>	24.1 <sup>(1)</sup>	29.8*	29.8*	28.0*	28.0*	26.3*	26.3*	24.6*	24.6*								
	- B							127.0 <sup>(1)</sup>	129.0 <sup>(2)</sup>	128.0 <sup>(2)</sup>	125.0 <sup>(2)</sup>		125.0 <sup>(1)</sup>	73.4	104.0 <sup>(2)</sup>	78.5	101.0 <sup>(2)</sup>	78.0	89.1 <sup>(2)</sup>								
250	- B						9.1 <sup>(1)</sup>	12.7 <sup>(2)</sup>	15.0 <sup>(1)</sup>	19.7 <sup>(1)</sup>	22.7 <sup>(1)</sup>	26.6	26.6	26.7*	26.7*	25.0*	25.0*	23.3*	23.3*								
	- B							122.0 <sup>(1)</sup>	127.0 <sup>(2)</sup>	125.0 <sup>(2)</sup>	124.0 <sup>(2)</sup>		122.0 <sup>(1)</sup>	67.8	103.0 <sup>(2)</sup>	74.9	99.9 <sup>(2)</sup>	75.5	88.1 <sup>(2)</sup>								
255	- B						7.3 <sup>(1)</sup>	10.4 <sup>(2)</sup>	12.7 <sup>(1)</sup>	16.8 <sup>(1)</sup>	19.7 <sup>(1)</sup>	23.8*	23.8*	22.1*	22.1*	20.2*	20.2*	18.4*	18.4*								
	- B							116.0 <sup>(1)</sup>	124.0 <sup>(2)</sup>	121.0 <sup>(2)</sup>	121.0 <sup>(2)</sup>		118.0 <sup>(1)</sup>	60.9	102.0 <sup>(2)</sup>	70.8	98.8 <sup>(2)</sup>	72.6	87.0 <sup>(2)</sup>								
260	- B								11.0 <sup>(1)</sup>	14.7 <sup>(2)</sup>	17.8 <sup>(1)</sup>	20.8 <sup>(1)</sup>	24.1 <sup>(1)</sup>	29.8*	29.8*	28.0*	28.0*	26.3*	26.3*								
	- B								119.0 <sup>(1)</sup>	118.0 <sup>(2)</sup>	118.0 <sup>(2)</sup>		118.0 <sup>(1)</sup>		115.0 <sup>(2)</sup>	66.8	97.8 <sup>(2)</sup>	69.8	86.0 <sup>(2)</sup>								
265	- B								9.1 <sup>(1)</sup>	12.7 <sup>(2)</sup>	15.0 <sup>(1)</sup>	19.7 <sup>(1)</sup>	22.7 <sup>(1)</sup>	26.6	26.6	26.7*	26.7*	25.0*	25.0*								
	- B								114.0 <sup>(1)</sup>	115.0 <sup>(2)</sup>	114.0 <sup>(2)</sup>		114.0 <sup>(1)</sup>		112.0 <sup>(2)</sup>	64.2	96.6 <sup>(2)</sup>	66.8	85.0 <sup>(2)</sup>								
270	- B								8.8 <sup>(1)</sup>	11.8 <sup>(2)</sup>	14.1 <sup>(1)</sup>	18.2 <sup>(1)</sup>	21.1 <sup>(1)</sup>	25.2*	25.2*	23.5*	23.5*	21.6*	21.6*								
	- B								109.0 <sup>(1)</sup>	113.0 <sup>(2)</sup>	112.0 <sup>(2)</sup>		112.0 <sup>(1)</sup>		110.0 <sup>(2)</sup>	60.9	97.5 <sup>(2)</sup>	63.5	83.9 <sup>(2)</sup>								
275	- B								10.5 <sup>(1)</sup>	14.1 <sup>(2)</sup>	17.1 <sup>(1)</sup>	21.2 <sup>(1)</sup>	24.2 <sup>(1)</sup>	28.3*	28.3*	26.6*	26.6*	24.9*	24.9*								
	- B								105.0 <sup>(1)</sup>	111.0 <sup>(2)</sup>	109.0 <sup>(2)</sup>		109.0 <sup>(1)</sup>		106.0 <sup>(2)</sup>	51.3	96.2 <sup>(2)</sup>	60.0	83.0 <sup>(2)</sup>								
280	- B								9.1 <sup>(1)</sup>	12.7 <sup>(2)</sup>	15.0 <sup>(1)</sup>	19.7 <sup>(1)</sup>	22.7 <sup>(1)</sup>	26.6	26.6	26.7*	26.7*	25.0*	25.0*								
	- B								114.0 <sup>(1)</sup>	115.0 <sup>(2)</sup>	114.0 <sup>(2)</sup>		114.0 <sup>(1)</sup>		112.0 <sup>(2)</sup>	51.3	96.2 <sup>(2)</sup>	60.0	83.0 <sup>(2)</sup>								
285	- B								8.8 <sup>(1)</sup>	11.8 <sup>(2)</sup>	14.1 <sup>(1)</sup>	18.2 <sup>(1)</sup>	21.1 <sup>(1)</sup>	25.2*	25.2*	23.5*	23.5*	21.6*	21.6*								
	- B								106.0 <sup>(1)</sup>	110.0 <sup>(2)</sup>	106.0 <sup>(2)</sup>		106.0 <sup>(1)</sup>		104.0 <sup>(2)</sup>	49.9	94.9 <sup>(2)</sup>	56.5	82.2 <sup>(2)</sup>								
290	- B								10.2 <sup>(1)</sup>	13.2 <sup>(2)</sup>	15.2 <sup>(1)</sup>	19.3 <sup>(1)</sup>	22.3 <sup>(1)</sup>	26.4*	26.4*	24.7*	24.7*	23.0*	23.0*								
	- B								102.0 <sup>(1)</sup>	104.0 <sup>(2)</sup>	104.0 <sup>(2)</sup>		104.0 <sup>(1)</sup>		101.0 <sup>(2)</sup>	48.8	93.6 <sup>(2)</sup>	52.6	81.2 <sup>(2)</sup>								
295	- B								9.7 <sup>(1)</sup>	12.7 <sup>(2)</sup>	14.7 <sup>(1)</sup>	18.8 <sup>(1)</sup>	21.8 <sup>(1)</sup>	25.9*	25.9*	24.2*	24.2*	22.5*	22.5*								
	- B								97.8 <sup>(1)</sup>	97.8 <sup>(2)</sup>	97.8 <sup>(2)</sup>		97.8 <sup>(1)</sup>		95.8 <sup>(2)</sup>	48.8	92.2 <sup>(2)</sup>	48.8	80.1 <sup>(2)</sup>								
300	- B								9.3 <sup>(1)</sup>	12.3 <sup>(2)</sup>	14.3 <sup>(1)</sup>	18.4 <sup>(1)</sup>	21.4 <sup>(1)</sup>	25.5*	25.5*	23.8*	23.8*	22.1*	22.1*								
	- B								93.8 <sup>(1)</sup>	99.9 <sup>(2)</sup>	99.9 <sup>(2)</sup>		99.9 <sup>(1)</sup>		96.2 <sup>(2)</sup>	43.1	87.7 <sup>(2)</sup>	43.1	79.0 <sup>(2)</sup>								
305	- B								9.4 <sup>(1)</sup>	12.4 <sup>(2)</sup>	14.4 <sup>(1)</sup>	18.5 <sup>(1)</sup>	21.5 <sup>(1)</sup>	25.6*	25.6*	23.9*	23.9*	22.2*	22.2*								
	- B								94.9 <sup>(1)</sup>	93.5 <sup>(2)</sup>	93.5 <sup>(2)</sup>		94.9 <sup>(1)</sup>		93.5 <sup>(2)</sup>	43.1	86.2 <sup>(2)</sup>	43.1	78.0 <sup>(2)</sup>								
310	- B								8.8 <sup>(1)</sup>	11.8 <sup>(2)</sup>	14.1 <sup>(1)</sup>	18.2 <sup>(1)</sup>	21.1 <sup>(1)</sup>	25.2*	25.2*	23.5*	23.5*	21.6*	21.6*								
	- B								91.5 <sup>(1)</sup>	91.5 <sup>(2)</sup>	91.5 <sup>(2)</sup>		91.5 <sup>(1)</sup>		88.1 <sup>(2)</sup>	41.9	84.8 <sup>(2)</sup>	41.9	74.4 <sup>(2)</sup>								
315	- B								8.8 <sup>(1)</sup>	11.8 <sup>(2)</sup>	14.1 <sup>(1)</sup>	18.2 <sup>(1)</sup>	21.1 <sup>(1)</sup>	25.2*	25.2*	23.5*	23.5*	21.6*	21.6*								
	- B								88.1 <sup>(1)</sup>	88.1 <sup>(2)</sup>	88.1 <sup>(2)</sup>		88.1 <sup>(1)</sup>		84.6 <sup>(2)</sup>	41.9	82.5 <sup>(2)</sup>	41.9	75.8 <sup>(2)</sup>								
320	- B								8.8 <sup>(1)</sup>	11.8 <sup>(2)</sup>	14.1 <sup>(1)</sup>	18.2 <sup>(1)</sup>	21.1 <sup>(1)</sup>	25.2*	25.2*	23.5*	23.5*	21.6*	21.6*								
	- B								81.9 <sup>(1)</sup>	81.9 <sup>(2)</sup>	81.9 <sup>(2)</sup>		81.9 <sup>(1)</sup>		79.2 <sup>(2)</sup>	41.9	81.5 <sup>(2)</sup>	41.9	73.7 <sup>(2)</sup>								
325	- B								7.9 <sup>(1)</sup>	10.9 <sup>(2)</sup>	12.9 <sup>(1)</sup>	17.0 <sup>(1)</sup>	20.0 <sup>(1)</sup>	24.1 <sup>(1)</sup>	27.1 <sup>(1)</sup>	27.1 <sup>(1)</sup>	25.4*	25.4*									
	- B								79.2 <sup>(1)</sup>	79.2 <sup>(2)</sup>	79.2 <sup>(2)</sup>		79.2 <sup>(1)</sup>		76.4 <sup>(2)</sup>	41.9	79.2 <sup>(2)</sup>	41.9	72.7 <sup>(2)</sup>								
330	- B								7.6 <sup>(1)</sup>	10.6 <sup>(2)</sup>	12.6 <sup>(1)</sup>	16.7 <sup>(1)</sup>	19.7 <sup>(1)</sup>	23.8*	23.8*	22.1*	22.1*	20.4*	20.4*								
	- B								76.4 <sup>(1)</sup>	76.4 <sup>(2)</sup>	76.4 <sup>(2)</sup>		76.4 <sup>(1)</sup>		73.7 <sup>(2)</sup>	41.9	76.4 <sup>(2)</sup>	41.9	71.6 <sup>(2)</sup>								
335	- B								7.3 <sup>(1)</sup>	10.3 <sup>(2)</sup>	12.3 <sup>(1)</sup>	16.4 <sup>(1)</sup>	19.4 <sup>(1)</sup>	23.5*	23.5*	21.8*	21.8*	20.1*	20.1*								
	- B								73.7 <sup>(1)</sup>	73.7 <sup>(2)</sup>	73.7 <sup>(2)</sup>		73.7 <sup>(1)</sup>		70.5 <sup>(2)</sup>	41.9	73.7 <sup>(2)</sup>	41.9	70.2 <sup>(2)</sup>								
340	- B								7.2 <sup>(1)</sup>	10.2 <sup>(2)</sup>	12.2 <sup>(1)</sup>	16.3 <sup>(1)</sup>	19.3 <sup>(1)</sup>	23.4*	23.4*	21.7*	21.7*	20.0*	20.0*								
	- B								72.4 <sup>(1)</sup>	72.4 <sup>(2)</sup>	72.4 <sup>(2)</sup>		72.4 <sup>(1)</sup>		69.4 <sup>(2)</sup>	41.9	72.4 <sup>(2)</sup>	41.9	68.5 <sup>(2)</sup>								
345	- B								7.0 <sup>(1)</sup>	10.0 <sup>(2)</sup>	12.0 <sup>(1)</sup>	16.1 <sup>(1)</sup>	19.1 <sup>(1)</sup>	23.2*	23.2*	21.5*	21.5*	19.8*	19.8*								
	- B								70.5 <sup>(1)</sup>	70.5 <sup>(2)</sup>	70.5 <sup>(2)</sup>		70.5 <sup>(1)</sup>		67.4 <sup>(2)</sup>	41.9	70.5 <sup>(2)</sup>	41.9	66.8 <sup>(2)</sup>								
350	- B								6.8 <sup>(1)</sup>	9.8 <sup>(2)</sup>	11.8 <sup>(1)</sup>	15.9 <sup>(1)</sup>	18.9 <sup>(1)</sup>	23.0*	23.0*	21.3*	21.3*										

# Lifting capacities Forces de levage

SDWB

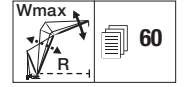
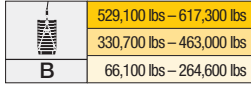

		S 177																								
		W 59		W 98		W 118		W 138		W 157		W 177		W 197		W 217		W 236		W 256		W 276				
		85	Wmax	87*/85	Wmax	87*/85	Wmax	87*/85	Wmax	87*/85	Wmax	87*/85	Wmax	87*/85	Wmax	87*/85	Wmax	87*/85	Wmax	87*/85	Wmax	87*/85	Wmax	87*/85	Wmax	
40	B			325.0*	325.0*																					
45	B	292.0	299.0 <sup>2)</sup>	291.0*	291.0*	280.0*	280.0*																			
50	B	264.0	273.0 <sup>2)</sup>	264.0*	264.0*	254.0*	254.0*																			
55	B	240.0	248.0 <sup>2)</sup>	240.0*	240.0*	232.0*	232.0*	225.0*	225.0*	217.0*	217.0*															
60	B	220.0	227.0 <sup>2)</sup>	221.0*	221.0*	213.0*	213.0*	207.0*	207.0*	193.0*	193.0*															
65	B	203.0	211.0 <sup>2)</sup>	204.0*	204.0*	197.0*	197.0*	191.0*	191.0*	185.0*	185.0*	179.0*	179.0*	173.0*	173.0*											
70	B	189.0	196.0 <sup>2)</sup>	190.0*	190.0*	183.0*	183.0*	178.0*	178.0*	172.0*	172.0*	166.0*	166.0*	160.0*	160.0*	156.0*	156.0*									
75	B	176.0	181.0 <sup>2)</sup>	177.0*	177.0*	170.0*	170.0*	166.0*	166.0*	160.0*	160.0*	155.0*	155.0*	149.0*	149.0*	146.0*	146.0*	141.0*	141.0*							
80	B	165.0	165.0	166.0 <sup>2)</sup>	166.0 <sup>2)</sup>	159.0*	159.0*	155.0*	155.0*	150.0*	150.0*	145.0*	145.0*	140.0*	140.0*	136.0*	136.0*	131.0*	131.0*	127.0*	127.0*					
85	B	152.0 <sup>1)</sup>	156.0 <sup>1)</sup>	156.0 <sup>1)</sup>	156.0 <sup>1)</sup>	150.0*	150.0*	146.0*	146.0*	141.0*	141.0*	136.0*	136.0*	131.0*	131.0*	128.0*	128.0*	123.0*	123.0*	119.0*	119.0*	115.0*	115.0*			
90	B	139.0 <sup>1)</sup>	147.0 <sup>1)</sup>	147.0 <sup>1)</sup>	147.0 <sup>1)</sup>	141.0*	141.0*	137.0*	137.0*	132.0*	132.0*	128.0*	128.0*	123.0*	123.0*	121.0*	121.0*	116.0*	116.0*	112.0*	112.0*	109.0*	109.0*	98.1*	98.1*	
95	B	126.0 <sup>1)</sup>	139.0 <sup>1)</sup>	139.0 <sup>1)</sup>	139.0 <sup>1)</sup>	133.0*	133.0*	129.0*	129.0*	125.0*	125.0*	121.0*	121.0*	116.0*	116.0*	114.0*	114.0*	109.0*	109.0*	106.0*	106.0*	102.0*	102.0*	96.8*	96.8*	
100	B	115.0 <sup>1)</sup>	125.0 <sup>1)</sup>	125.0 <sup>1)</sup>	126.0 <sup>1)</sup>	123.0*	123.0*	118.0*	118.0*	114.0*	114.0*	110.0*	110.0*	107.0*	107.0*	107.0*	107.0*	103.0*	103.0*	99.6*	99.6*	96.5*	96.5*	93.1*	93.1*	
105	B	105.0 <sup>1)</sup>	115.0 <sup>1)</sup>	115.0 <sup>1)</sup>	120.0*	116.0*	116.0*	112.0*	112.0*	108.0*	108.0*	104.0*	104.0*	102.0*	102.0*	102.0*	102.0*	97.4*	97.4*	94.2*	94.2*	91.2*	91.2*	87.9*	87.9*	
110	B	95.0 <sup>1)</sup>	105.0 <sup>1)</sup>	105.0 <sup>1)</sup>	112.0*	110.0*	110.0*	106.0*	106.0*	103.0*	103.0*	98.6*	98.6*	96.2*	96.2*	96.2*	96.2*	92.2*	92.2*	89.1*	89.1*	86.3*	86.3*	83.1*	83.1*	
115	B	86.9 <sup>1)</sup>	94.8 <sup>1)</sup>	94.8 <sup>1)</sup>	106.0*	105.0*	105.0*	101.0*	101.0*	97.7*	97.7*	93.6*	93.6*	91.3*	91.3*	91.3*	91.3*	87.4*	87.4*	84.4*	84.4*	81.7*	81.7*	78.6*	78.6*	
120	B	80.4 <sup>1)</sup>	87.6 <sup>1)</sup>	87.6 <sup>1)</sup>	96.1	96.1	98.7*	96.3*	96.3*	92.9*	92.9*	89.0*	89.0*	86.8*	86.8*	86.8*	86.8*	83.0*	83.0*	80.1*	80.1*	77.5*	77.5*	74.6*	74.6*	
125	B	73.9 <sup>1)</sup>	80.3 <sup>1)</sup>	80.3 <sup>1)</sup>	87.3 <sup>1)</sup>	87.3 <sup>1)</sup>	93.3*	93.3*	91.2*	88.6*	88.6*	84.7*	84.7*	82.6*	82.6*	82.6*	82.6*	78.9*	78.9*	76.0*	76.0*	73.5*	73.5*	70.6*	70.6*	
130	B	67.4 <sup>1)</sup>	73.1 <sup>1)</sup>	73.1 <sup>1)</sup>	79.9 <sup>1)</sup>	79.9 <sup>1)</sup>	88.4*	88.4*	86.3*	84.4*	84.4*	80.8*	80.8*	78.7*	78.7*	78.7*	78.7*	75.1*	75.1*	72.3*	72.3*	69.8*	69.8*	67.1*	67.1*	
135	B	60.9 <sup>1)</sup>	67.4 <sup>1)</sup>	67.4 <sup>1)</sup>	73.1 <sup>1)</sup>	73.1 <sup>1)</sup>	83.8*	83.8*	81.8*	79.9*	79.9*	77.1*	77.1*	75.1*	75.1*	75.1*	75.1*	71.5*	71.5*	68.8*	68.8*	66.4*	66.4*	63.7*	63.7*	
140	B	54.4 <sup>1)</sup>	62.3 <sup>1)</sup>	62.3 <sup>1)</sup>	67.6 <sup>1)</sup>	67.6 <sup>1)</sup>	76.4	76.4	77.7*	77.7*	75.8*	73.4*	73.4*	71.7*	71.7*	71.7*	71.7*	68.2*	68.2*	65.5*	65.5*	63.1*	63.1*	60.5*	60.5*	
145	B	49.1 <sup>1)</sup>	57.3 <sup>1)</sup>	57.3 <sup>1)</sup>	62.0 <sup>1)</sup>	62.0 <sup>1)</sup>	68.6 <sup>1)</sup>	68.6 <sup>1)</sup>	73.9*	73.9*	72.0*	72.0*	69.6*	69.6*	68.4*	68.4*	68.4*	68.4*	65.1*	65.1*	62.4*	62.4*	60.2*	60.2*	57.6*	57.6*
150	B	44.9 <sup>1)</sup>	52.2 <sup>1)</sup>	52.2 <sup>1)</sup>	56.4 <sup>1)</sup>	56.4 <sup>1)</sup>	62.9 <sup>1)</sup>	62.9 <sup>1)</sup>	70.3*	70.3*	68.4*	66.1*	66.1*	65.0*	65.0*	65.0*	65.0*	62.2*	62.2*	59.6*	59.6*	57.3*	57.3*	54.7*	54.7*	
155	B	40.8 <sup>1)</sup>	47.1 <sup>1)</sup>	47.1 <sup>1)</sup>	52.1 <sup>1)</sup>	52.1 <sup>1)</sup>	57.9 <sup>1)</sup>	57.9 <sup>1)</sup>	64.0	64.0	65.1*	62.8*	61.7*	61.7*	61.7*	61.7*	59.3*	59.3*	56.9*	56.9*	54.6*	54.6*	52.1*	52.1*		
160	B	36.6 <sup>1)</sup>	42.1 <sup>1)</sup>	42.1 <sup>1)</sup>	48.0 <sup>1)</sup>	48.0 <sup>1)</sup>	53.5 <sup>1)</sup>	53.5 <sup>1)</sup>	61.0	61.0	62.1*	59.8*	58.7*	58.7*	58.7*	58.7*	56.2*	56.2*	54.3*	54.3*	52.1*	52.1*	49.6*	49.6*		
165	B	32.5 <sup>1)</sup>	37.8 <sup>1)</sup>	37.8 <sup>1)</sup>	44.0 <sup>1)</sup>	44.0 <sup>1)</sup>	49.0 <sup>1)</sup>	49.0 <sup>1)</sup>	58.0*	58.0*	59.2*	56.9*	55.8*	55.8*	55.8*	55.8*	53.4*	53.4*	51.6*	51.6*	49.7*	49.7*	47.3*	47.3*		
170	B	28.5 <sup>1)</sup>	34.4 <sup>1)</sup>	34.4 <sup>1)</sup>	39.9 <sup>1)</sup>	39.9 <sup>1)</sup>	44.5 <sup>1)</sup>	44.5 <sup>1)</sup>	56.6*	56.6*	54.3*	53.2*	53.2*	53.2*	53.2*	53.2*	50.8*	50.8*	49.0*	49.0*	47.3*	47.3*	45.1*	45.1*		
175	B	25.8 <sup>1)</sup>	31.0 <sup>1)</sup>	31.0 <sup>1)</sup>	35.8 <sup>1)</sup>	35.8 <sup>1)</sup>	41.1 <sup>1)</sup>	41.1 <sup>1)</sup>	51.3	51.3	51.8*	51.8*	50.7*	50.7*	50.7*	50.7*	48.3*	48.3*	46.6*	46.6*	44.9*	44.9*	42.9*	42.9*		
180	B	23.1 <sup>1)</sup>	27.6 <sup>1)</sup>	27.6 <sup>1)</sup>	31.7 <sup>1)</sup>	31.7 <sup>1)</sup>	37.7 <sup>1)</sup>	37.7 <sup>1)</sup>	49.1	49.1	49.4*	49.4*	48.4*	48.4*	48.4*	48.4*	46.0*	46.0*	44.3*	44.3*	42.6*	42.6*	40.8*	40.8*		
185	B	20.4 <sup>1)</sup>	24.3 <sup>1)</sup>	24.3 <sup>1)</sup>	28.2 <sup>1)</sup>	28.2 <sup>1)</sup>	34.3 <sup>1)</sup>	34.3 <sup>1)</sup>	45.2*	45.2*	44.1*	44.1*	44.1*	44.1*	44.1*	44.1*	42.1*	42.1*	40.5*	40.5*	38.7*	38.7*	37.0*	37.0*		
190	B	18.8 <sup>1)</sup>	22.9 <sup>1)</sup>	22.9 <sup>1)</sup>	27.4 <sup>1)</sup>	27.4 <sup>1)</sup>	31.7 <sup>1)</sup>	31.7 <sup>1)</sup>	42.1*	42.1*	41.1*	41.1*	41.1*	41.1*	41.1*	41.1*	39.8*	39.8*	38.1*	38.1*	36.5*	36.5*	34.7*	34.7*		
195	B	17.8 <sup>1)</sup>	20.9 <sup>1)</sup>	20.9 <sup>1)</sup>	25.5 <sup>1)</sup>	25.5 <sup>1)</sup>	30.9 <sup>1)</sup>	30.9 <sup>1)</sup>	40.7	40.7	42.1*	42.1*	42.1*	42.1*	42.1*	42.1*	40.2*	40.2*	38.4*	38.4*	36.8*	36.8*	35.1*	35.1*		
200	B	16.6 <sup>1)</sup>	20.2 <sup>1)</sup>	20.2 <sup>1)</sup>	24.0 <sup>1)</sup>	24.0 <sup>1)</sup>	28.9 <sup>1)</sup>	28.9 <sup>1)</sup>	39.1	39.1	40.3*	40.3*	40.3*	40.3*	40.3*	40.3*	38.0*	38.0*	36.3*	36.3*	34.7*	34.7*	32.9*	32.9*		
205	B	14.4 <sup>1)</sup>	17.6 <sup>1)</sup>	17.6 <sup>1)</sup>	21.1 <sup>1)</sup>	21.1 <sup>1)</sup>	26.1 <sup>1)</sup>	26.1 <sup>1)</sup>	32.3 <sup>1)</sup>	32.3 <sup>1)</sup>	33.6*	33.6*	33.6*	33.6*	33.6*	33.6*	31.6*	31.6*	30.0*	30.0*	28.4*	28.4*	26.8*	26.8*		
210	B	12.2 <sup>1)</sup>	14.6 <sup>1)</sup>	14.6 <sup>1)</sup>	19.0 <sup>1)</sup>	19.0 <sup>1)</sup>	23.4 <sup>1)</sup>	23.4 <sup>1)</sup>	30.9 <sup>1)</sup>	30.9 <sup>1)</sup>	32.3 <sup>1)</sup>	32.3 <sup>1)</sup>	32.3 <sup>1)</sup>	32.3 <sup>1)</sup>	32.3 <sup>1)</sup>	32.3 <sup>1)</sup>	30.3*	30.3*	28.7*	28.7*	27.1*	27.1*	25.5*	25.5*		
215	B	10.5 <sup>1)</sup>	12.6 <sup>1)</sup>	12.6 <sup>1)</sup>	16.8 <sup>1)</sup>	16.8 <sup>1)</sup>	20.6 <sup>1)</sup>	20.6 <sup>1)</sup>	28.9 <sup>1)</sup>	28.9 <sup>1)</sup>	30.3*	30.3*	30.3*	30.3*	30.3*	30.3*	28.3*	28.3*	26.7*	26.7*	25.1*	25.1*	23.5*	23.5*		
220	B	8.8 <sup>1)</sup>	10.5 <sup>1)</sup>	10.5 <sup>1)</sup>	14.7 <sup>1)</sup>	14.7 <sup>1)</sup>	18.9 <sup>1)</sup>	18.9 <sup>1)</sup>	27.1 <sup>1)</sup>	27.1 <sup>1)</sup>	28.5*	28.5*	28.5*	28.5*	28.5*	28.5*	26.9*	26.9*	25.3*	25.3*	23.7*	23.7*	22.1*	22.1*		

1) 12°; 2) 17°; 3) 22°; 4) 27°; 5) 32°; 6) 37°; 7) 42°; 8) 47°; 9) 52°; 10) 57°; 11) 62°

# Lifting capacities Forces de levage

**SDWB**



286,600 lbs –  
374,800 lbs



529,100 lbs – 617,300 lbs  
330,700 lbs – 463,000 lbs  
66,100 lbs – 264,600 lbs



**60**

		S 177																														
		W 59		W 79		W 98		W 118		W 138		W 157		W 177		W 197		W 217		W 236		W 256		W 276								
		85	Wmax	87*/85	Wmax	87*/85	Wmax	87*/85	Wmax	87*/85	Wmax	87*/85	Wmax	87*/85	Wmax	87*/85	Wmax	87*/85	Wmax	87*/85	Wmax	87*/85	Wmax	87*/85	Wmax	87*/85	Wmax					
225	- B				8.4 <sup>1)</sup>		12.5 <sup>2)</sup>		14.9 <sup>3)</sup>		19.6 <sup>4)</sup>		21.7 <sup>5)</sup>		25.3 <sup>6)</sup>	30.2*	30.2*	28.5*	28.5*	26.8*	26.8*	25.1*	25.1*									
	-				142.0 <sup>7)</sup>		146.0 <sup>8)</sup>		149.0 <sup>9)</sup>		148.0 <sup>10)</sup>		145.0 <sup>11)</sup>		143.0 <sup>12)</sup>	88.8	134.0 <sup>13)</sup>	85.7	106.0 <sup>14)</sup>	86.7	101.0 <sup>15)</sup>	79.3	87.4 <sup>16)</sup>									
230	- B				136.0 <sup>7)</sup>		140.0 <sup>8)</sup>		144.0 <sup>9)</sup>		144.0 <sup>10)</sup>		141.0 <sup>11)</sup>		140.0 <sup>12)</sup>	82.4	133.0 <sup>13)</sup>	83.4	105.0 <sup>14)</sup>	84.3	101.0 <sup>15)</sup>	78.0	87.0 <sup>16)</sup>									
235	- B						136.0 <sup>7)</sup>		139.0 <sup>8)</sup>		141.0 <sup>9)</sup>		138.0 <sup>10)</sup>		136.0 <sup>11)</sup>	75.7	130.0 <sup>12)</sup>	81.0	104.0 <sup>13)</sup>	82.0	99.7 <sup>14)</sup>	76.7	86.7 <sup>15)</sup>									
240	- B								131.0 <sup>7)</sup>		134.0 <sup>8)</sup>		136.0 <sup>9)</sup>		134.0 <sup>10)</sup>		132.0 <sup>11)</sup>	78.2	103.0 <sup>12)</sup>	79.6	98.8 <sup>13)</sup>	74.8	86.3 <sup>14)</sup>									
245	- B								126.0 <sup>7)</sup>		130.0 <sup>8)</sup>		132.0 <sup>9)</sup>		130.0 <sup>10)</sup>		129.0 <sup>11)</sup>	75.2	102.0 <sup>12)</sup>	77.2	97.8 <sup>13)</sup>	72.6	85.7 <sup>14)</sup>									
250	- B								122.0 <sup>7)</sup>		124.0 <sup>8)</sup>		128.0 <sup>9)</sup>		126.0 <sup>10)</sup>		125.0 <sup>11)</sup>	70.1	101.0 <sup>12)</sup>	74.8	96.9 <sup>13)</sup>	70.6	85.3 <sup>14)</sup>									
255	- B										120.0 <sup>7)</sup>		124.0 <sup>8)</sup>		120.0 <sup>9)</sup>		119.0 <sup>10)</sup>	64.2	99.4 <sup>11)</sup>	71.5	95.9 <sup>12)</sup>	68.5	85.0 <sup>13)</sup>									
260	- B										116.0 <sup>7)</sup>		120.0 <sup>8)</sup>		118.0 <sup>9)</sup>		118.0 <sup>10)</sup>		98.2 <sup>11)</sup>	68.1	95.0 <sup>12)</sup>	66.5	84.3 <sup>13)</sup>									
265	- B										112.0 <sup>7)</sup>		116.0 <sup>8)</sup>		115.0 <sup>9)</sup>		115.0 <sup>10)</sup>		96.9 <sup>11)</sup>	64.4	94.0 <sup>12)</sup>	64.4	83.3 <sup>13)</sup>									
270	- B										107.0 <sup>7)</sup>		111.0 <sup>8)</sup>		111.0 <sup>9)</sup>		111.0 <sup>10)</sup>		95.6 <sup>11)</sup>	59.7	93.1 <sup>12)</sup>	62.3	82.2 <sup>13)</sup>									
275	- B											107.0 <sup>7)</sup>		108.0 <sup>8)</sup>		108.0 <sup>9)</sup>		109.0 <sup>10)</sup>		94.3 <sup>11)</sup>	54.2	92.2 <sup>12)</sup>	60.0	81.2 <sup>13)</sup>								
280	- B												104.0 <sup>7)</sup>		105.0 <sup>8)</sup>		105.0 <sup>9)</sup>		93.1 <sup>10)</sup>	57.6	91.2 <sup>11)</sup>	57.6	80.2 <sup>12)</sup>									
285	- B												100.0 <sup>7)</sup>		102.0 <sup>8)</sup>		102.0 <sup>9)</sup>		91.8 <sup>10)</sup>	54.4	90.3 <sup>11)</sup>	54.4	79.4 <sup>12)</sup>									
290	- B												96.8 <sup>7)</sup>		98.5 <sup>8)</sup>		98.8 <sup>9)</sup>		90.5 <sup>10)</sup>	50.5	89.0 <sup>11)</sup>	50.5	78.6 <sup>12)</sup>									
295	- B													95.3 <sup>7)</sup>		96.3 <sup>8)</sup>		94.4 <sup>9)</sup>		89.2 <sup>10)</sup>	45.5	87.4 <sup>11)</sup>	45.5	77.8 <sup>12)</sup>								
300	- B													92.2 <sup>7)</sup>		94.2 <sup>8)</sup>		91.8 <sup>9)</sup>		87.9 <sup>10)</sup>		85.9 <sup>11)</sup>		77.1 <sup>12)</sup>								
305	- B													89.0 <sup>7)</sup>		92.3 <sup>8)</sup>		89.6 <sup>9)</sup>		86.7 <sup>10)</sup>		84.3 <sup>11)</sup>		76.2 <sup>12)</sup>								
310	- B													85.8 <sup>7)</sup>		88.4 <sup>8)</sup>		87.5 <sup>9)</sup>		85.4 <sup>10)</sup>		82.8 <sup>11)</sup>		75.3 <sup>12)</sup>								
315	- B														85.3 <sup>7)</sup>		85.8 <sup>8)</sup>		83.3 <sup>9)</sup>		81.2 <sup>10)</sup>		74.4 <sup>11)</sup>									
320	- B														82.2 <sup>7)</sup>		83.9 <sup>8)</sup>		81.9 <sup>9)</sup>		79.7 <sup>10)</sup>		73.4 <sup>11)</sup>									
325	- B														79.1 <sup>7)</sup>		82.5 <sup>8)</sup>		80.0 <sup>9)</sup>		78.1 <sup>10)</sup>		72.5 <sup>11)</sup>									
330	- B														75.9 <sup>7)</sup>		79.1 <sup>8)</sup>		78.6 <sup>9)</sup>		76.6 <sup>10)</sup>		71.6 <sup>11)</sup>									
335	- B															76.4 <sup>7)</sup>		77.1 <sup>8)</sup>		75.0 <sup>9)</sup>		70.7 <sup>10)</sup>										
340	- B																73.8 <sup>7)</sup>		75.6 <sup>8)</sup>		73.2 <sup>9)</sup>		69.8 <sup>10)</sup>									
345	- B																71.1 <sup>7)</sup>		74.2 <sup>8)</sup>		71.8 <sup>9)</sup>		68.8 <sup>10)</sup>									
350	- B																68.4 <sup>7)</sup>		71.2 <sup>8)</sup>		70.1 <sup>9)</sup>		67.9 <sup>10)</sup>									
355	- B																	68.7 <sup>7)</sup>		68.3 <sup>8)</sup>		67.0 <sup>9)</sup>		67.0 <sup>10)</sup>								
360	- B																	66.3 <sup>7)</sup>		66.3 <sup>8)</sup>		65.0 <sup>9)</sup>		65.0 <sup>10)</sup>								
365	- B																	63.9 <sup>7)</sup>		65.5 <sup>8)</sup>		63.0 <sup>9)</sup>		63.0 <sup>10)</sup>								
370	- B																	61.5 <sup>7)</sup>		62.5 <sup>8)</sup>		61.0 <sup>9)</sup>		61.0 <sup>10)</sup>								
375	- B																			60.6 <sup>7)</sup>		59.2 <sup>8)</sup>		59.2 <sup>9)</sup>								
380	- B																			58.7 <sup>7)</sup>		57.4 <sup>8)</sup>		57.4 <sup>9)</sup>								
385	- B																			56.8 <sup>7)</sup>		55.9 <sup>8)</sup>		55.9 <sup>9)</sup>								
390	- B																					54.1 <sup>7)</sup>		54.1 <sup>8)</sup>								
395	- B																						52.5 <sup>7)</sup>		52.5 <sup>8)</sup>							
400	- B																							51.0 <sup>7)</sup>		51.0 <sup>8)</sup>						
405	- B																								49.5 <sup>7)</sup>		49.5 <sup>8)</sup>					

1) 12°; 2) 17°; 3) 22°; 4) 27°; 5) 32°; 6) 37°; 7) 42°; 8) 47°; 9) 52°; 10) 57°; 11) 62°





# Lifting capacities Forces de levage

SDWB

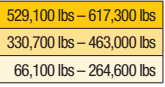

		S 197																																										
		W 59		W 79		W 98		W 118		W 138		W 157		W 177		W 197		W 217		W 236		W 256		W 276																				
		85	Wmax	87*/85	Wmax	87*/85	Wmax	87*/85	Wmax	87*/85	Wmax	87*/85	Wmax	87*/85	Wmax	87*/85	Wmax	87*/85	Wmax	87*/85	Wmax	87*/85	Wmax	87*/85	Wmax	87*/85	Wmax																	
235	- B					132.0 <sup>9</sup>		135.0 <sup>9</sup>		139.0 <sup>9</sup>		137.0 <sup>9</sup>		135.0 <sup>9</sup>		132.0 <sup>9</sup>		78.4		125.0 <sup>9</sup>		78.2		102.0 <sup>9</sup>		74.8		125.0 <sup>9</sup>		78.2		102.0 <sup>9</sup>		74.8		102.0 <sup>9</sup>		74.8		96.0 <sup>9</sup>		70.7		83.4 <sup>9</sup>
240	- B					127.0 <sup>9</sup>		130.0 <sup>9</sup>		134.0 <sup>9</sup>		134.0 <sup>9</sup>		131.0 <sup>9</sup>		129.0 <sup>9</sup>		69.5		124.0 <sup>9</sup>		76.4		101.0 <sup>9</sup>		72.7		95.4 <sup>9</sup>		68.8		83.1 <sup>9</sup>		68.8		83.1 <sup>9</sup>		68.8		83.1 <sup>9</sup>		68.8		83.1 <sup>9</sup>
245	- B					122.0 <sup>9</sup>		125.0 <sup>9</sup>		129.0 <sup>9</sup>		131.0 <sup>9</sup>		128.0 <sup>9</sup>		123.0 <sup>9</sup>		69.5		120.0 <sup>9</sup>		71.3		98.5 <sup>9</sup>		68.5		94.5 <sup>9</sup>		64.3		82.2 <sup>9</sup>		64.3		82.2 <sup>9</sup>		64.3		82.2 <sup>9</sup>		64.3		82.2 <sup>9</sup>
250	- B							121.0 <sup>9</sup>		125.0 <sup>9</sup>		127.0 <sup>9</sup>		125.0 <sup>9</sup>		123.0 <sup>9</sup>		69.5		120.0 <sup>9</sup>		71.3		98.5 <sup>9</sup>		68.5		94.5 <sup>9</sup>		64.3		82.2 <sup>9</sup>		64.3		82.2 <sup>9</sup>		64.3		82.2 <sup>9</sup>		64.3		82.2 <sup>9</sup>
255	- B							117.0 <sup>9</sup>		120.0 <sup>9</sup>		123.0 <sup>9</sup>		122.0 <sup>9</sup>		120.0 <sup>9</sup>		69.5		120.0 <sup>9</sup>		71.3		98.5 <sup>9</sup>		68.5		94.5 <sup>9</sup>		64.3		82.2 <sup>9</sup>		64.3		82.2 <sup>9</sup>		64.3		82.2 <sup>9</sup>		64.3		82.2 <sup>9</sup>
260	- B							113.0 <sup>9</sup>		115.0 <sup>9</sup>		119.0 <sup>9</sup>		119.0 <sup>9</sup>		117.0 <sup>9</sup>		69.5		117.0 <sup>9</sup>		71.3		98.5 <sup>9</sup>		68.5		94.5 <sup>9</sup>		64.3		82.2 <sup>9</sup>		64.3		82.2 <sup>9</sup>		64.3		82.2 <sup>9</sup>		64.3		82.2 <sup>9</sup>
265	- B							109.0 <sup>9</sup>		111.0 <sup>9</sup>		115.0 <sup>9</sup>		117.0 <sup>9</sup>		114.0 <sup>9</sup>		69.5		114.0 <sup>9</sup>		71.3		98.5 <sup>9</sup>		68.5		94.5 <sup>9</sup>		64.3		82.2 <sup>9</sup>		64.3		82.2 <sup>9</sup>		64.3		82.2 <sup>9</sup>		64.3		82.2 <sup>9</sup>
270	- B									108.0 <sup>9</sup>		111.0 <sup>9</sup>		113.0 <sup>9</sup>		112.0 <sup>9</sup>		69.5		112.0 <sup>9</sup>		71.3		98.5 <sup>9</sup>		68.5		94.5 <sup>9</sup>		64.3		82.2 <sup>9</sup>		64.3		82.2 <sup>9</sup>		64.3		82.2 <sup>9</sup>		64.3		82.2 <sup>9</sup>
275	- B									104.0 <sup>9</sup>		107.0 <sup>9</sup>		110.0 <sup>9</sup>		109.0 <sup>9</sup>		69.5		109.0 <sup>9</sup>		71.3		98.5 <sup>9</sup>		68.5		94.5 <sup>9</sup>		64.3		82.2 <sup>9</sup>		64.3		82.2 <sup>9</sup>		64.3		82.2 <sup>9</sup>		64.3		82.2 <sup>9</sup>
280	- B									101.0 <sup>9</sup>		102.0 <sup>9</sup>		106.0 <sup>9</sup>		106.0 <sup>9</sup>		69.5		106.0 <sup>9</sup>		71.3		98.5 <sup>9</sup>		68.5		94.5 <sup>9</sup>		64.3		82.2 <sup>9</sup>		64.3		82.2 <sup>9</sup>		64.3		82.2 <sup>9</sup>		64.3		82.2 <sup>9</sup>
285	- B									96.9 <sup>9</sup>		99.0 <sup>9</sup>		103.0 <sup>9</sup>		103.0 <sup>9</sup>		69.5		103.0 <sup>9</sup>		71.3		98.5 <sup>9</sup>		68.5		94.5 <sup>9</sup>		64.3		82.2 <sup>9</sup>		64.3		82.2 <sup>9</sup>		64.3		82.2 <sup>9</sup>		64.3		82.2 <sup>9</sup>
290	- B											95.8 <sup>9</sup>		99.1 <sup>9</sup>		100.0 <sup>9</sup>		69.5		100.0 <sup>9</sup>		71.3		98.5 <sup>9</sup>		68.5		94.5 <sup>9</sup>		64.3		82.2 <sup>9</sup>		64.3		82.2 <sup>9</sup>		64.3		82.2 <sup>9</sup>		64.3		82.2 <sup>9</sup>
295	- B											92.6 <sup>9</sup>		95.5 <sup>9</sup>		97.4 <sup>9</sup>		69.5		97.4 <sup>9</sup>		71.3		98.5 <sup>9</sup>		68.5		94.5 <sup>9</sup>		64.3		82.2 <sup>9</sup>		64.3		82.2 <sup>9</sup>		64.3		82.2 <sup>9</sup>		64.3		82.2 <sup>9</sup>
300	- B											89.4 <sup>9</sup>		91.3 <sup>9</sup>		94.5 <sup>9</sup>		69.5		94.5 <sup>9</sup>		71.3		98.5 <sup>9</sup>		68.5		94.5 <sup>9</sup>		64.3		82.2 <sup>9</sup>		64.3		82.2 <sup>9</sup>		64.3		82.2 <sup>9</sup>		64.3		82.2 <sup>9</sup>
305	- B											86.2 <sup>9</sup>		88.4 <sup>9</sup>		91.6 <sup>9</sup>		69.5		91.6 <sup>9</sup>		71.3		98.5 <sup>9</sup>		68.5		94.5 <sup>9</sup>		64.3		82.2 <sup>9</sup>		64.3		82.2 <sup>9</sup>		64.3		82.2 <sup>9</sup>		64.3		82.2 <sup>9</sup>
310	- B													85.6 <sup>9</sup>		88.7 <sup>9</sup>		69.5		88.7 <sup>9</sup>		71.3		98.5 <sup>9</sup>		68.5		94.5 <sup>9</sup>		64.3		82.2 <sup>9</sup>		64.3		82.2 <sup>9</sup>		64.3		82.2 <sup>9</sup>		64.3		82.2 <sup>9</sup>
315	- B													82.7 <sup>9</sup>		85.8 <sup>9</sup>		69.5		85.8 <sup>9</sup>		71.3		98.5 <sup>9</sup>		68.5		94.5 <sup>9</sup>		64.3		82.2 <sup>9</sup>		64.3		82.2 <sup>9</sup>		64.3		82.2 <sup>9</sup>		64.3		82.2 <sup>9</sup>
320	- B													79.8 <sup>9</sup>		82.2 <sup>9</sup>		69.5		82.2 <sup>9</sup>		71.3		98.5 <sup>9</sup>		68.5		94.5 <sup>9</sup>		64.3		82.2 <sup>9</sup>		64.3		82.2 <sup>9</sup>		64.3		82.2 <sup>9</sup>		64.3		82.2 <sup>9</sup>
325	- B													76.9 <sup>9</sup>		79.5 <sup>9</sup>		69.5		79.5 <sup>9</sup>		71.3		98.5 <sup>9</sup>		68.5		94.5 <sup>9</sup>		64.3		82.2 <sup>9</sup>		64.3		82.2 <sup>9</sup>		64.3		82.2 <sup>9</sup>		64.3		82.2 <sup>9</sup>
330	- B															76.9 <sup>9</sup>		69.5		76.9 <sup>9</sup>		71.3		98.5 <sup>9</sup>		68.5		94.5 <sup>9</sup>		64.3		82.2 <sup>9</sup>		64.3		82.2 <sup>9</sup>		64.3		82.2 <sup>9</sup>		64.3		82.2 <sup>9</sup>
335	- B															74.3 <sup>9</sup>		69.5		74.3 <sup>9</sup>		71.3		98.5 <sup>9</sup>		68.5		94.5 <sup>9</sup>		64.3		82.2 <sup>9</sup>		64.3		82.2 <sup>9</sup>		64.3		82.2 <sup>9</sup>		64.3		82.2 <sup>9</sup>
340	- B															71.7 <sup>9</sup>		69.5		71.7 <sup>9</sup>		71.3		98.5 <sup>9</sup>		68.5		94.5 <sup>9</sup>		64.3		82.2 <sup>9</sup>		64.3		82.2 <sup>9</sup>		64.3		82.2 <sup>9</sup>		64.3		82.2 <sup>9</sup>
345	- B																	69.5		70.6 <sup>9</sup>		71.3		98.5 <sup>9</sup>		68.5		94.5 <sup>9</sup>		64.3		82.2 <sup>9</sup>		64.3		82.2 <sup>9</sup>		64.3		82.2 <sup>9</sup>		64.3		82.2 <sup>9</sup>
350	- B																	69.5		68.3 <sup>9</sup>		71.3		98.5 <sup>9</sup>		68.5		94.5 <sup>9</sup>		64.3		82.2 <sup>9</sup>		64.3		82.2 <sup>9</sup>		64.3		82.2 <sup>9</sup>		64.3		82.2 <sup>9</sup>
355	- B																	69.5		65.9 <sup>9</sup>		71.3		98.5 <sup>9</sup>		68.5		94.5 <sup>9</sup>		64.3		82.2 <sup>9</sup>		64.3		82.2 <sup>9</sup>		64.3		82.2 <sup>9</sup>		64.3		82.2 <sup>9</sup>
360	- B																	69.5		63.6 <sup>9</sup>		71.3		98.5 <sup>9</sup>		68.5		94.5 <sup>9</sup>		64.3		82.2 <sup>9</sup>		64.3		82.2 <sup>9</sup>		64.3		82.2 <sup>9</sup>		64.3		82.2 <sup>9</sup>
365	- B																	69.5				71.3		98.5 <sup>9</sup>		68.5		94.5 <sup>9</sup>		64.3		82.2 <sup>9</sup>		64.3		82.2 <sup>9</sup>		64.3		82.2 <sup>9</sup>		64.3		82.2 <sup>9</sup>
370	- B																	69.5				71.3		98.5 <sup>9</sup>		68.5		94.5 <sup>9</sup>		64.3		82.2 <sup>9</sup>		64.3		82.2 <sup>9</sup>		64.3		82.2 <sup>9</sup>		64.3		82.2 <sup>9</sup>
375	- B																	69.5				71.3		98.5 <sup>9</sup>		68.5		94.5 <sup>9</sup>		64.3		82.2 <sup>9</sup>		64.3		82.2 <sup>9</sup>		64.3		82.2 <sup>9</sup>		64.3		82.2 <sup>9</sup>
380	- B																	69.5				71.3		98.5 <sup>9</sup>		68.5		94.5 <sup>9</sup>		64.3		82.2 <sup>9</sup>		64.3		82.2 <sup>9</sup>		64.3		82.2 <sup>9</sup>		64.3		82.2 <sup>9</sup>
385	- B																	69.5				71.3		98.5 <sup>9</sup>		68.5		94.5 <sup>9</sup>		64.3		82.2 <sup>9</sup>		64.3		82.2 <sup>9</sup>		64.3		82.2 <sup>9</sup>		64.3		82.2 <sup>9</sup>
390	- B																	69.5				71.3		98.5 <sup>9</sup>		68.5		94.5 <sup>9</sup>		64.3		82.2 <sup>9</sup>		64.3		82.2 <sup>9</sup>		64.3		82.2 <sup>9</sup>		64.3		82.2 <sup>9</sup>
395	- B																	69.5				71.3		98.5 <sup>9</sup>		68.5		94.5 <sup>9</sup>		64.3		82.2 <sup>9</sup>		64.3		82.2 <sup>9</sup>		64.3		82.2 <sup>9</sup>		64.3		82.2 <sup>9</sup>
400	- B																	69.5				71.3		98.5 <sup>9</sup>		68.5		94.5 <sup>9</sup>		64.3		82.2 <sup>9</sup>		64.3		82.2 <sup>9</sup>		64.3		82.2 <sup>9</sup>		64.3		82.2 <sup>9</sup>
405	- B																	69.5				71.3		98.5 <sup>9</sup>		68.5		94.5 <sup>9</sup> </																



# Lifting capacities Forces de levage

SDWB

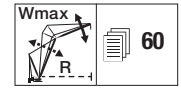
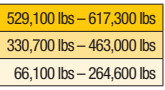

		S 217																														
		W 59		W 79		W 98		W 118		W 138		W 157		W 177		W 197		W 217		W 236		W 256		W 276								
		85	Wmax	87*/85	Wmax	87*/85	Wmax	87*/85	Wmax	87*/85	Wmax	87*/85	Wmax	87*/85	Wmax	87*/85	Wmax	87*/85	Wmax	87*/85	Wmax	87*/85	Wmax	87*/85	Wmax	87*/85	Wmax					
245	- B					122.0 <sup>2)</sup>		126.0 <sup>3)</sup>		128.0 <sup>4)</sup>		127.0 <sup>5)</sup>		125.0 <sup>6)</sup>		122.0 <sup>7)</sup>		122.0 <sup>8)</sup>		17.4 <sup>11)</sup>		21.9*	21.9*	20.4*	20.4*	18.9*	18.9*					
250	- B					118.0 <sup>2)</sup>		121.0 <sup>3)</sup>		124.0 <sup>4)</sup>		124.0 <sup>5)</sup>		122.0 <sup>6)</sup>		120.0 <sup>7)</sup>		120.0 <sup>8)</sup>		12.6 <sup>11)</sup>		21.0*	21.0*	19.5*	19.5*	18.0*	18.0*					
255	- B					113.0 <sup>2)</sup>		116.0 <sup>3)</sup>		120.0 <sup>4)</sup>		121.0 <sup>5)</sup>		119.0 <sup>6)</sup>		116.0 <sup>7)</sup>		116.0 <sup>8)</sup>		10.5 <sup>11)</sup>		20.3*	20.3*	18.7*	18.7*	17.2*	17.2*					
260	- B					109.0 <sup>2)</sup>		113.0 <sup>3)</sup>		115.0 <sup>4)</sup>		118.0 <sup>5)</sup>		116.0 <sup>6)</sup>		114.0 <sup>7)</sup>		114.0 <sup>8)</sup>		11.1 <sup>11)</sup>		17.2	17.2	17.8*	17.8*	16.3*	16.3*					
265	- B							109.0 <sup>2)</sup>		111.0 <sup>3)</sup>		114.0 <sup>4)</sup>		114.0 <sup>5)</sup>		111.0 <sup>6)</sup>		111.0 <sup>7)</sup>		10.6 <sup>11)</sup>		11.8 <sup>11)</sup>	17.1*	17.1*	17.1*	15.5*	15.5*					
270	- B							105.0 <sup>2)</sup>		107.0 <sup>3)</sup>		110.0 <sup>4)</sup>		111.0 <sup>5)</sup>		109.0 <sup>6)</sup>		109.0 <sup>7)</sup>		9.8 <sup>11)</sup>		9.3 <sup>11)</sup>	16.4*	16.4*	16.4*	14.8*	14.8*					
275	- B							101.0 <sup>2)</sup>		103.0 <sup>3)</sup>		106.0 <sup>4)</sup>		109.0 <sup>5)</sup>		106.0 <sup>6)</sup>		106.0 <sup>7)</sup>		6.2 <sup>10)</sup>		9.0 <sup>11)</sup>	13.5	13.5	14.1*	14.1*	14.1*					
280	- B							97.4 <sup>2)</sup>		99.5 <sup>3)</sup>		103.0 <sup>4)</sup>		105.0 <sup>5)</sup>		104.0 <sup>6)</sup>		101.0 <sup>7)</sup>		4.3 <sup>10)</sup>		8.9 <sup>11)</sup>	12.9	12.9	13.4*	13.4*	13.4*					
285	- B									96.2 <sup>2)</sup>		98.8 <sup>3)</sup>		102.0 <sup>4)</sup>		101.0 <sup>5)</sup>		99.0 <sup>6)</sup>		89.0 <sup>3)</sup>		51.4	83.4 <sup>4)</sup>	48.5	72.2 <sup>5)</sup>	48.5	72.2 <sup>5)</sup>					
290	- B									92.9 <sup>2)</sup>		95.0 <sup>3)</sup>		98.4 <sup>4)</sup>		99.5 <sup>5)</sup>		96.3 <sup>6)</sup>				87.1 <sup>4)</sup>		82.7 <sup>5)</sup>	45.7	71.5 <sup>6)</sup>	45.7	71.5 <sup>6)</sup>				
295	- B											89.6 <sup>2)</sup>		91.2 <sup>3)</sup>		95.1 <sup>4)</sup>		97.5 <sup>5)</sup>				94.7 <sup>6)</sup>		86.2 <sup>7)</sup>	82.3 <sup>8)</sup>	44.6	71.2 <sup>9)</sup>	8.8	8.8			
300	- B													88.3 <sup>2)</sup>		91.8 <sup>3)</sup>		94.4 <sup>4)</sup>				94.4 <sup>6)</sup>		85.6 <sup>7)</sup>	82.1 <sup>8)</sup>	43.1	70.9 <sup>9)</sup>	8.4	8.4			
305	- B													85.3 <sup>2)</sup>		88.5 <sup>3)</sup>		91.4 <sup>4)</sup>				91.4 <sup>6)</sup>		83.6 <sup>7)</sup>	81.8 <sup>8)</sup>		70.6 <sup>9)</sup>					
310	- B													82.4 <sup>2)</sup>		84.3 <sup>3)</sup>		88.4 <sup>4)</sup>				88.4 <sup>6)</sup>		82.9 <sup>7)</sup>	81.6 <sup>8)</sup>		70.3 <sup>9)</sup>					
315	- B													79.5 <sup>2)</sup>		81.6 <sup>3)</sup>		85.5 <sup>4)</sup>				85.5 <sup>6)</sup>		81.0 <sup>7)</sup>	81.3 <sup>8)</sup>		70.0 <sup>9)</sup>					
320	- B															78.9 <sup>2)</sup>		82.5 <sup>3)</sup>				82.5 <sup>6)</sup>		80.1 <sup>7)</sup>	79.8 <sup>8)</sup>		69.7 <sup>9)</sup>					
325	- B															76.2 <sup>2)</sup>		79.5 <sup>3)</sup>				79.5 <sup>6)</sup>		78.0 <sup>7)</sup>	77.7 <sup>8)</sup>		69.4 <sup>9)</sup>					
330	- B															73.5 <sup>2)</sup>		75.4 <sup>3)</sup>				75.4 <sup>6)</sup>		76.1 <sup>7)</sup>	75.6 <sup>8)</sup>		69.2 <sup>9)</sup>					
335	- B															70.8 <sup>2)</sup>		73.0 <sup>3)</sup>				73.0 <sup>6)</sup>		74.1 <sup>7)</sup>	73.5 <sup>8)</sup>		68.4 <sup>9)</sup>					
340	- B																	70.6 <sup>2)</sup>				70.6 <sup>6)</sup>		72.2 <sup>7)</sup>	71.6 <sup>8)</sup>		67.3 <sup>9)</sup>					
345	- B																	68.2 <sup>2)</sup>				68.2 <sup>6)</sup>		70.3 <sup>7)</sup>	69.6 <sup>8)</sup>		67.0 <sup>9)</sup>					
350	- B																	65.8 <sup>2)</sup>				65.8 <sup>6)</sup>		68.4 <sup>7)</sup>	67.8 <sup>8)</sup>		65.4 <sup>9)</sup>					
355	- B																	63.4 <sup>2)</sup>				63.4 <sup>6)</sup>		64.7 <sup>7)</sup>	66.1 <sup>8)</sup>		63.9 <sup>9)</sup>					
360	- B																					62.6 <sup>2)</sup>		64.7 <sup>7)</sup>	64.5 <sup>8)</sup>		62.3 <sup>9)</sup>					
365	- B																					60.4 <sup>2)</sup>		62.8 <sup>7)</sup>	62.8 <sup>8)</sup>		60.7 <sup>9)</sup>					
370	- B																					58.2 <sup>2)</sup>		59.8 <sup>7)</sup>	61.1 <sup>8)</sup>		59.2 <sup>9)</sup>					
375	- B																					56.0 <sup>2)</sup>		57.8 <sup>7)</sup>	59.5 <sup>8)</sup>		57.6 <sup>9)</sup>					
380	- B																							55.8 <sup>2)</sup>	57.8 <sup>8)</sup>		56.3 <sup>9)</sup>					
385	- B																							53.8 <sup>2)</sup>	56.1 <sup>8)</sup>		55.0 <sup>9)</sup>					
390	- B																							51.8 <sup>2)</sup>	53.3 <sup>8)</sup>		53.7 <sup>9)</sup>					
395	- B																							49.7 <sup>2)</sup>	51.4 <sup>8)</sup>		52.4 <sup>9)</sup>					
400	- B																									49.5 <sup>2)</sup>	51.1 <sup>8)</sup>		51.1 <sup>9)</sup>			
405	- B																									47.6 <sup>2)</sup>	49.8 <sup>8)</sup>		49.8 <sup>9)</sup>			
410	- B																									45.8 <sup>2)</sup>	47.1 <sup>8)</sup>		47.1 <sup>9)</sup>			
415	- B																									43.9 <sup>2)</sup>	45.3 <sup>8)</sup>		45.3 <sup>9)</sup>			
420	- B																											43.5 <sup>2)</sup>				
425	- B																											41.7 <sup>2)</sup>				
430	- B																											39.9 <sup>2)</sup>				
435	- B																											38.1 <sup>2)</sup>				

1) 12°; 2) 17°; 3) 22°; 4) 27°; 5) 32°; 6) 37°; 7) 42°; 8) 47°; 9) 52°; 10) 57°; 11) 62°

# Lifting capacities Forces de levage

**SDWB**



286,600 lbs -  
374,800 lbs



529,100 lbs - 617,300 lbs  
330,700 lbs - 463,000 lbs  
66,100 lbs - 264,600 lbs



**60**

		S 236																									
		W 59		W 79		W 98		W 118		W 138		W 157		W 177		W 197		W 217		W 236		W 256		W 276			
ft		85	Wmax	87°/85	Wmax	87°/85	Wmax	87°/85	Wmax	87°/85	Wmax	87°/85	Wmax	87°/85	Wmax	87°/85	Wmax	87°/85	Wmax	87°/85	Wmax	87°/85	Wmax	87°/85	Wmax		
45	B			259.0*	259.0 <sup>(1)</sup>																						
50	B	233.0	244.0 <sup>(2)</sup>	236.0*	236.0*	228.0*	228.0 <sup>(1)</sup>																				
55	B	213.0	223.0 <sup>(2)</sup>	217.0*	217.0*	209.0*	209.0*	202.0*	202.0*																		
60	B	196.0	205.0 <sup>(2)</sup>	200.0*	200.0*	193.0*	193.0*	186.0*	186.0*	179.0*	179.0 <sup>(1)</sup>																
65	B	182.0	192.0 <sup>(2)</sup>	186.0*	186.0*	179.0*	179.0*	173.0*	173.0*	166.0*	166.0*	160.0*	160.0 <sup>(1)</sup>														
70	B	169.0	177.0 <sup>(2)</sup>	173.0*	173.0*	167.0*	167.0*	161.0*	161.0*	155.0*	155.0*	149.0*	149.0*	144.0*	144.0 <sup>(1)</sup>												
75	B	158.0	166.0 <sup>(2)</sup>	162.0*	162.0*	156.0*	156.0*	150.0*	150.0 <sup>(1)</sup>	145.0*	145.0*	139.0*	139.0*	135.0*	135.0*	130.0*	130.0 <sup>(1)</sup>										
80	B	149.0	154.0 <sup>(2)</sup>	152.0*	152.0*	147.0*	147.0*	141.0*	141.0*	136.0*	136.0*	130.0*	130.0*	126.0*	126.0*	122.0*	122.0*	117.0*	117.0 <sup>(1)</sup>								
85	B	140.0	140.0 <sup>(2)</sup>	143.0*	143.0*	138.0*	138.0*	133.0*	133.0*	127.0*	127.0*	122.0*	122.0*	119.0*	119.0*	115.0*	115.0*	110.0*	110.0*	103.0*	103.0 <sup>(1)</sup>						
90	B	129.0 <sup>(1)</sup>	135.0*	135.0*	135.0*	130.0*	130.0*	125.0*	125.0*	120.0*	120.0*	115.0*	115.0*	112.0*	112.0*	108.0*	108.0*	103.0*	103.0*	99.9*	99.9*	89.8*	89.8*	89.8*	89.8*	78.6*	78.6*
95	B	119.0 <sup>(1)</sup>	128.0*	128.0*	128.0*	123.0*	123.0*	118.0*	118.0*	113.0*	113.0*	109.0*	109.0*	105.0*	105.0*	102.0*	102.0*	97.5*	97.5*	94.1*	94.1*	88.5*	88.5*	88.5*	88.5*	77.6*	77.6*
100	B	108.0 <sup>(1)</sup>	115.0*	117.0 <sup>(1)</sup>	117.0*	112.0*	112.0*	107.0*	107.0*	102.0*	102.0*	97.5*	97.5*	94.4*	94.4*	91.1*	91.1*	87.0*	87.0*	83.8*	83.8*	81.1*	81.1*	81.1*	81.1*	75.7*	75.7*
105	B	97.8 <sup>(1)</sup>	109.0*	109.0*	109.0*	111.0*	111.0*	107.0*	107.0*	102.0*	102.0*	97.5*	97.5*	94.4*	94.4*	91.1*	91.1*	87.0*	87.0*	83.8*	83.8*	81.1*	81.1*	81.1*	81.1*	75.7*	75.7*
110	B	89.8 <sup>(1)</sup>	99.9*	99.9*	99.9*	106.0*	106.0*	101.0*	101.0*	96.8*	96.8*	92.5*	92.5*	89.5*	89.5*	86.3*	86.3*	82.4*	82.4*	79.3*	79.3*	76.7*	76.7*	76.7*	76.7*	73.6*	73.6*
115	B	82.7 <sup>(1)</sup>	92.0*	92.0*	92.0*	101.0*	101.0*	96.7*	96.7*	92.1*	92.1*	87.9*	87.9*	85.0*	85.0*	81.9*	81.9*	78.1*	78.1*	75.1*	75.1*	72.6*	72.6*	72.6*	72.6*	69.6*	69.6*
120	B	75.5 <sup>(1)</sup>	84.1 <sup>(1)</sup>	84.1 <sup>(1)</sup>	84.1 <sup>(1)</sup>	90.5*	90.5*	87.8*	87.8*	83.7*	83.7*	80.9*	80.9*	77.8*	77.8*	74.1*	74.1*	71.1*	71.1*	68.7*	68.7*	65.9*	65.9*	65.9*	65.9*	62.4*	62.4*
125	B	68.4 <sup>(1)</sup>	76.3 <sup>(1)</sup>	76.3 <sup>(1)</sup>	76.3 <sup>(1)</sup>	86.7	86.7	83.3*	83.3*	80.1*	80.1*	77.0*	77.0*	74.1*	74.1*	71.1*	71.1*	67.6*	67.6*	65.2*	65.2*	62.4*	62.4*	62.4*	62.4*	59.1*	59.1*
130	B	62.3 <sup>(1)</sup>	70.4 <sup>(1)</sup>	70.4 <sup>(1)</sup>	70.4 <sup>(1)</sup>	78.0 <sup>(1)</sup>	78.0 <sup>(1)</sup>	74.6*	74.6*	71.5*	71.5*	68.6*	68.6*	65.4*	65.4*	62.2*	62.2*	58.8*	58.8*	56.2*	56.2*	53.0*	53.0*	53.0*	53.0*	50.4*	50.4*
135	B	57.5 <sup>(1)</sup>	64.6 <sup>(1)</sup>	64.6 <sup>(1)</sup>	64.6 <sup>(1)</sup>	71.6 <sup>(1)</sup>	71.6 <sup>(1)</sup>	68.6*	68.6*	65.7*	65.7*	62.7*	62.7*	59.7*	59.7*	56.7*	56.7*	53.7*	53.7*	51.0*	51.0*	48.2*	48.2*	48.2*	48.2*	45.0*	45.0*
140	B	52.8 <sup>(1)</sup>	58.8 <sup>(1)</sup>	58.8 <sup>(1)</sup>	58.8 <sup>(1)</sup>	65.3 <sup>(1)</sup>	65.3 <sup>(1)</sup>	62.3*	62.3*	59.3*	59.3*	56.3*	56.3*	53.3*	53.3*	50.3*	50.3*	47.3*	47.3*	44.5*	44.5*	41.7*	41.7*	41.7*	41.7*	38.5*	38.5*
145	B	48.0 <sup>(1)</sup>	52.9 <sup>(1)</sup>	52.9 <sup>(1)</sup>	52.9 <sup>(1)</sup>	59.3 <sup>(1)</sup>	59.3 <sup>(1)</sup>	56.3*	56.3*	53.3*	53.3*	50.3*	50.3*	47.3*	47.3*	44.3*	44.3*	41.3*	41.3*	38.3*	38.3*	35.3*	35.3*	35.3*	35.3*	32.1*	32.1*
150	B	43.2 <sup>(1)</sup>	48.3 <sup>(1)</sup>	48.3 <sup>(1)</sup>	48.3 <sup>(1)</sup>	54.6 <sup>(1)</sup>	54.6 <sup>(1)</sup>	51.6*	51.6*	48.6*	48.6*	45.6*	45.6*	42.6*	42.6*	39.6*	39.6*	36.6*	36.6*	33.6*	33.6*	30.6*	30.6*	30.6*	30.6*	27.4*	27.4*
155	B	38.4 <sup>(1)</sup>	44.5 <sup>(1)</sup>	44.5 <sup>(1)</sup>	44.5 <sup>(1)</sup>	49.8 <sup>(1)</sup>	49.8 <sup>(1)</sup>	46.8*	46.8*	43.8*	43.8*	40.8*	40.8*	37.8*	37.8*	34.8*	34.8*	31.8*	31.8*	28.8*	28.8*	25.8*	25.8*	25.8*	25.8*	22.6*	22.6*
160	B	33.7 <sup>(1)</sup>	40.6 <sup>(1)</sup>	40.6 <sup>(1)</sup>	40.6 <sup>(1)</sup>	45.1 <sup>(1)</sup>	45.1 <sup>(1)</sup>	42.1*	42.1*	39.1*	39.1*	36.1*	36.1*	33.1*	33.1*	30.1*	30.1*	27.1*	27.1*	24.1*	24.1*	21.1*	21.1*	21.1*	21.1*	17.9*	17.9*
165	B	28.9 <sup>(1)</sup>	36.7 <sup>(1)</sup>	36.7 <sup>(1)</sup>	36.7 <sup>(1)</sup>	40.3 <sup>(1)</sup>	40.3 <sup>(1)</sup>	37.3*	37.3*	34.3*	34.3*	31.3*	31.3*	28.3*	28.3*	25.3*	25.3*	22.3*	22.3*	19.3*	19.3*	16.3*	16.3*	16.3*	16.3*	13.1*	13.1*
170	B	25.1 <sup>(1)</sup>	32.8 <sup>(1)</sup>	32.8 <sup>(1)</sup>	32.8 <sup>(1)</sup>	36.8 <sup>(1)</sup>	36.8 <sup>(1)</sup>	33.8*	33.8*	30.8*	30.8*	27.8*	27.8*	24.8*	24.8*	21.8*	21.8*	18.8*	18.8*	15.8*	15.8*	12.8*	12.8*	12.8*	12.8*	9.6*	9.6*
175	B	22.2 <sup>(1)</sup>	29.0 <sup>(1)</sup>	29.0 <sup>(1)</sup>	29.0 <sup>(1)</sup>	33.6 <sup>(1)</sup>	33.6 <sup>(1)</sup>	30.6*	30.6*	27.6*	27.6*	24.6*	24.6*	21.6*	21.6*	18.6*	18.6*	15.6*	15.6*	12.6*	12.6*	9.6*	9.6*	9.6*	9.6*	6.4*	6.4*
180	B	19.3 <sup>(1)</sup>	25.1 <sup>(1)</sup>	25.1 <sup>(1)</sup>	25.1 <sup>(1)</sup>	30.3 <sup>(1)</sup>	30.3 <sup>(1)</sup>	27.3*	27.3*	24.3*	24.3*	21.3*	21.3*	18.3*	18.3*	15.3*	15.3*	12.3*	12.3*	9.3*	9.3*	6.3*	6.3*	6.3*	6.3*	3.1*	3.1*
185	B	16.4 <sup>(1)</sup>	21.2 <sup>(1)</sup>	21.2 <sup>(1)</sup>	21.2 <sup>(1)</sup>	27.1 <sup>(1)</sup>	27.1 <sup>(1)</sup>	24.1*	24.1*	21.1*	21.1*	18.1*	18.1*	15.1*	15.1*	12.1*	12.1*	9.1*	9.1*	6.1*	6.1*	3.1*	3.1*	3.1*	3.1*		
190	B	13.4 <sup>(1)</sup>	17.0 <sup>(1)</sup>	17.0 <sup>(1)</sup>	17.0 <sup>(1)</sup>	23.0 <sup>(1)</sup>	23.0 <sup>(1)</sup>	20.0*	20.0*	17.0*	17.0*	14.0*	14.0*	11.0*	11.0*	8.0*	8.0*	5.0*	5.0*	2.0*	2.0*						
195	B	10.6 <sup>(1)</sup>	13.0 <sup>(1)</sup>	13.0 <sup>(1)</sup>	13.0 <sup>(1)</sup>	19.0 <sup>(1)</sup>	19.0 <sup>(1)</sup>	16.0*	16.0*	13.0*	13.0*	10.0*	10.0*	7.0*	7.0*	4.0*	4.0*	1.0*	1.0*								
200	B	7.7 <sup>(1)</sup>	9.0 <sup>(1)</sup>	9.0 <sup>(1)</sup>	9.0 <sup>(1)</sup>	14.0 <sup>(1)</sup>	14.0 <sup>(1)</sup>	11.0*	11.0*	8.0*	8.0*	5.0*	5.0*	2.0*	2.0*												
205	B	5.0 <sup>(1)</sup>	6.0 <sup>(1)</sup>	6.0 <sup>(1)</sup>	6.0 <sup>(1)</sup>	10.0 <sup>(1)</sup>	10.0 <sup>(1)</sup>	7.0*	7.0*	4.0*	4.0*	1.0*	1.0*														
210	B	3.0 <sup>(1)</sup>	4.0 <sup>(1)</sup>	4.0 <sup>(1)</sup>	4.0 <sup>(1)</sup>	6.0 <sup>(1)</sup>	6.0 <sup>(1)</sup>	3.0*	3.0*	1.0*	1.0*																
215	B	2.0 <sup>(1)</sup>	3.0 <sup>(1)</sup>	3.0 <sup>(1)</sup>	3.0 <sup>(1)</sup>	4.0 <sup>(1)</sup>	4.0 <sup>(1)</sup>	1.0*	1.0*																		
220	B	1.5 <sup>(1)</sup>	2.0 <sup>(1)</sup>	2.0 <sup>(1)</sup>	2.0 <sup>(1)</sup>	3.0 <sup>(1)</sup>	3.0 <sup>(1)</sup>	0.5*	0.5*																		
225	B	1.0 <sup>(1)</sup>	1.5 <sup>(1)</sup>	1.5 <sup>(1)</sup>	1.5 <sup>(1)</sup>	2.0 <sup>(1)</sup>	2.0 <sup>(1)</sup>	0.5*	0.5*																		
230	B	0.8 <sup>(1)</sup>	1.0 <sup>(1)</sup>	1.0 <sup>(1)</sup>	1.0 <sup>(1)</sup>	1.5 <sup>(1)</sup>	1.5 <sup>(1)</sup>	0.5*	0.5*																		
235	B	0.6 <sup>(1)</sup>	0.8 <sup>(1)</sup>	0.8 <sup>(1)</sup>	0.8 <sup>(1)</sup>	1.0 <sup>(1)</sup>	1.0 <sup>(1)</sup>	0.5*	0.5*																		
240	B	0.5 <sup>(1)</sup>	0.6 <sup>(1)</sup>	0.6 <sup>(1)</sup>	0.6 <sup>(1)</sup>	0.8 <sup>(1)</sup>	0.8 <sup>(1)</sup>	0.5*	0.5*																		
245	B	0.4 <sup>(1)</sup>	0.5 <sup>(1)</sup>	0.5 <sup>(1)</sup>	0.5 <sup>(1)</sup>	0.6 <sup>(1)</sup>	0.6 <sup>(1)</sup>	0.5*	0.5*																		

1) 12°; 2) 17°; 3) 22°; 4) 27°; 5) 32°; 6) 37°; 7) 42°; 8) 47°; 9) 52°; 10) 57°; 11) 62°

# Lifting capacities Forces de levage

**SDWB**

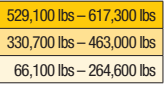

		S 236																												
		W 59		W 79		W 98		W 118		W 138		W 157		W 177		W 197		W 217		W 236		W 256		W 276						
		85	Wmax	87*/85	Wmax	87*/85	Wmax	87*/85	Wmax	87*/85	Wmax	87*/85	Wmax	87*/85	Wmax	87*/85	Wmax	87*/85	Wmax	87*/85	Wmax	87*/85	Wmax	87*/85	Wmax					
250	B			113.0 <sup>1)</sup>		116.0 <sup>2)</sup>		120.0 <sup>3)</sup>		122.0 <sup>4)</sup>		120.0 <sup>5)</sup>		118.0 <sup>6)</sup>		106.0 <sup>7)</sup>		11.1 <sup>11)</sup>		13.7 <sup>11)</sup>		20.2*	20.2*	18.7*	18.7*	17.1*	17.1*			
255	B					112.0 <sup>2)</sup>		116.0 <sup>3)</sup>		118.0 <sup>4)</sup>		117.0 <sup>5)</sup>		115.0 <sup>6)</sup>		105.0 <sup>7)</sup>		8.9 <sup>11)</sup>		11.5 <sup>11)</sup>		19.4*	19.4*	17.9*	17.9*	16.2*	16.2*			
260	B							108.0 <sup>2)</sup>		111.0 <sup>3)</sup>		114.0 <sup>4)</sup>		115.0 <sup>5)</sup>		112.0 <sup>6)</sup>		6.6 <sup>11)</sup>		9.4 <sup>11)</sup>		16.1	16.1	17.0*	17.0*	15.3*	15.3*			
265	B					104.0 <sup>2)</sup>		107.0 <sup>3)</sup>		110.0 <sup>4)</sup>		112.0 <sup>5)</sup>		109.0 <sup>6)</sup>		104.0 <sup>7)</sup>		7.3 <sup>11)</sup>		7.3 <sup>11)</sup>		10.5 <sup>11)</sup>		16.3*	16.3*	14.5*	14.5*			
270	B							101.0 <sup>2)</sup>		103.0 <sup>3)</sup>		106.0 <sup>4)</sup>		108.0 <sup>5)</sup>		107.0 <sup>6)</sup>		9.2 <sup>3)</sup>		9.2 <sup>3)</sup>		81.9 <sup>9)</sup>		50.3	50.3	45.8	45.8			
275	B									99.6 <sup>2)</sup>		102.0 <sup>3)</sup>		105.0 <sup>4)</sup>		105.0 <sup>5)</sup>		102.0 <sup>6)</sup>		7.3 <sup>11)</sup>		10.5 <sup>11)</sup>		16.3*	16.3*	14.5*	14.5*			
280	B									96.2 <sup>2)</sup>		98.2 <sup>3)</sup>		101.0 <sup>4)</sup>		102.0 <sup>5)</sup>		99.1 <sup>9)</sup>		9.2 <sup>3)</sup>		81.9 <sup>9)</sup>		50.3	50.3	45.8	45.8			
285	B									92.8 <sup>2)</sup>		94.1 <sup>3)</sup>		97.7 <sup>4)</sup>		101.0 <sup>5)</sup>		99.1 <sup>9)</sup>		8.9 <sup>11)</sup>		9.2 <sup>3)</sup>		10.5 <sup>11)</sup>		16.3*	16.3*			
290	B									89.3 <sup>2)</sup>		91.0 <sup>3)</sup>		94.3 <sup>4)</sup>		96.8 <sup>5)</sup>		95.7 <sup>6)</sup>		8.9 <sup>11)</sup>		89.3 <sup>9)</sup>		79.8 <sup>4)</sup>		70.8 <sup>4)</sup>	40.0	61.9 <sup>4)</sup>		
295	B											88.0 <sup>2)</sup>		90.8 <sup>3)</sup>		93.6 <sup>4)</sup>		93.5 <sup>5)</sup>		8.9 <sup>11)</sup>		89.3 <sup>9)</sup>		79.8 <sup>4)</sup>		70.8 <sup>4)</sup>	10.7*	10.7*		
300	B											84.9 <sup>2)</sup>		87.3 <sup>3)</sup>		90.5 <sup>4)</sup>		91.9 <sup>5)</sup>		8.9 <sup>11)</sup>		87.3 <sup>9)</sup>		78.7 <sup>5)</sup>		70.1 <sup>4)</sup>	6.7	61.3 <sup>4)</sup>		
305	B											81.9 <sup>2)</sup>		83.4 <sup>3)</sup>		87.4 <sup>4)</sup>		90.5 <sup>5)</sup>		8.9 <sup>11)</sup>		85.5 <sup>7)</sup>		78.4 <sup>5)</sup>		69.7 <sup>4)</sup>		60.9 <sup>4)</sup>		
310	B											78.8 <sup>2)</sup>		80.6 <sup>3)</sup>		84.2 <sup>4)</sup>		86.8 <sup>5)</sup>		8.9 <sup>11)</sup>		85.1 <sup>7)</sup>		77.7 <sup>6)</sup>		69.4 <sup>4)</sup>		60.6 <sup>4)</sup>		
315	B												77.9 <sup>2)</sup>		81.1 <sup>3)</sup>		84.0 <sup>4)</sup>		86.8 <sup>5)</sup>		8.9 <sup>11)</sup>		83.8 <sup>8)</sup>		76.8 <sup>6)</sup>		68.9 <sup>4)</sup>		60.3 <sup>4)</sup>	
320	B												75.2 <sup>2)</sup>		78.0 <sup>3)</sup>		81.2 <sup>4)</sup>		86.8 <sup>5)</sup>		8.9 <sup>11)</sup>		82.4 <sup>8)</sup>		76.3 <sup>6)</sup>		68.7 <sup>4)</sup>		60.0 <sup>4)</sup>	
325	B												72.4 <sup>2)</sup>		74.5 <sup>3)</sup>		78.4 <sup>4)</sup>		86.8 <sup>5)</sup>		8.9 <sup>11)</sup>		79.9 <sup>8)</sup>		75.4 <sup>7)</sup>		68.5 <sup>4)</sup>		59.8 <sup>4)</sup>	
330	B												69.7 <sup>2)</sup>		72.0 <sup>3)</sup>		75.6 <sup>4)</sup>		86.8 <sup>5)</sup>		8.9 <sup>11)</sup>		77.3 <sup>8)</sup>		74.3 <sup>7)</sup>		67.5 <sup>4)</sup>		59.7 <sup>4)</sup>	
335	B													69.6 <sup>2)</sup>		72.8 <sup>3)</sup>		74.7 <sup>4)</sup>		86.8 <sup>5)</sup>		8.9 <sup>11)</sup>		74.7 <sup>8)</sup>		73.9 <sup>6)</sup>		67.5 <sup>4)</sup>		59.5 <sup>4)</sup>
340	B													67.1 <sup>2)</sup>		69.9 <sup>3)</sup>		72.1 <sup>4)</sup>		86.8 <sup>5)</sup>		8.9 <sup>11)</sup>		72.1 <sup>8)</sup>		73.0 <sup>6)</sup>		66.2 <sup>4)</sup>		59.3 <sup>4)</sup>
345	B													64.6 <sup>2)</sup>		66.6 <sup>3)</sup>		69.6 <sup>4)</sup>		86.8 <sup>5)</sup>		8.9 <sup>11)</sup>		69.6 <sup>8)</sup>		70.8 <sup>6)</sup>		66.2 <sup>4)</sup>		58.5 <sup>4)</sup>
350	B													62.1 <sup>2)</sup>		64.3 <sup>3)</sup>		67.0 <sup>4)</sup>		86.8 <sup>5)</sup>		8.9 <sup>11)</sup>		67.0 <sup>8)</sup>		68.6 <sup>6)</sup>		65.5 <sup>4)</sup>		58.6 <sup>4)</sup>
355	B														62.1 <sup>2)</sup>		64.4 <sup>3)</sup>		69.6 <sup>4)</sup>		8.9 <sup>11)</sup>		64.4 <sup>8)</sup>		66.3 <sup>6)</sup>		65.4 <sup>4)</sup>		58.2 <sup>4)</sup>	
360	B														59.8 <sup>2)</sup>		61.8 <sup>3)</sup>		69.6 <sup>4)</sup>		8.9 <sup>11)</sup>		61.8 <sup>8)</sup>		64.1 <sup>6)</sup>		65.0 <sup>4)</sup>		57.8 <sup>4)</sup>	
365	B														57.5 <sup>2)</sup>		58.7 <sup>3)</sup>		69.6 <sup>4)</sup>		8.9 <sup>11)</sup>		58.7 <sup>8)</sup>		61.9 <sup>6)</sup>		63.0 <sup>4)</sup>		57.5 <sup>4)</sup>	
370	B														55.2 <sup>2)</sup>		56.6 <sup>3)</sup>		69.6 <sup>4)</sup>		8.9 <sup>11)</sup>		55.2 <sup>8)</sup>		59.6 <sup>6)</sup>		61.0 <sup>4)</sup>		57.3 <sup>4)</sup>	
375	B															54.5 <sup>2)</sup>		56.6 <sup>3)</sup>		69.6 <sup>4)</sup>		8.9 <sup>11)</sup>		54.5 <sup>8)</sup>		57.4 <sup>6)</sup>		59.0 <sup>4)</sup>		57.2 <sup>4)</sup>
380	B															52.4 <sup>2)</sup>		56.6 <sup>3)</sup>		69.6 <sup>4)</sup>		8.9 <sup>11)</sup>		52.4 <sup>8)</sup>		55.2 <sup>6)</sup>		57.0 <sup>4)</sup>		56.6 <sup>4)</sup>
385	B															50.3 <sup>2)</sup>		56.6 <sup>3)</sup>		69.6 <sup>4)</sup>		8.9 <sup>11)</sup>		50.3 <sup>8)</sup>		52.2 <sup>6)</sup>		55.0 <sup>4)</sup>		55.0 <sup>4)</sup>
390	B																48.3 <sup>2)</sup>		56.6 <sup>3)</sup>		69.6 <sup>4)</sup>		8.9 <sup>11)</sup>		48.3 <sup>8)</sup>		50.3 <sup>6)</sup>		53.3 <sup>4)</sup>	
395	B																	56.6 <sup>3)</sup>		69.6 <sup>4)</sup>		8.9 <sup>11)</sup>				48.4 <sup>6)</sup>		51.0 <sup>4)</sup>		51.7 <sup>4)</sup>
400	B																	56.6 <sup>3)</sup>		69.6 <sup>4)</sup>		8.9 <sup>11)</sup>				46.5 <sup>6)</sup>		47.8 <sup>4)</sup>		50.0 <sup>4)</sup>
405	B																	56.6 <sup>3)</sup>		69.6 <sup>4)</sup>		8.9 <sup>11)</sup>				44.6 <sup>6)</sup>		46.0 <sup>4)</sup>		48.4 <sup>4)</sup>
410	B																	56.6 <sup>3)</sup>		69.6 <sup>4)</sup>		8.9 <sup>11)</sup>				42.7 <sup>6)</sup>		44.3 <sup>4)</sup>		46.7 <sup>4)</sup>
415	B																	56.6 <sup>3)</sup>		69.6 <sup>4)</sup>		8.9 <sup>11)</sup>					42.5 <sup>6)</sup>		45.0 <sup>4)</sup>	
420	B																	56.6 <sup>3)</sup>		69.6 <sup>4)</sup>		8.9 <sup>11)</sup>					40.7 <sup>6)</sup>		41.7 <sup>4)</sup>	
425	B																	56.6 <sup>3)</sup>		69.6 <sup>4)</sup>		8.9 <sup>11)</sup>					39.0 <sup>6)</sup>		39.6 <sup>4)</sup>	
430	B																	56.6 <sup>3)</sup>		69.6 <sup>4)</sup>		8.9 <sup>11)</sup>					37.2 <sup>6)</sup>		37.5 <sup>4)</sup>	
435	B																	56.6 <sup>3)</sup>		69.6 <sup>4)</sup>		8.9 <sup>11)</sup>							35.5 <sup>4)</sup>	
440	B																	56.6 <sup>3)</sup>		69.6 <sup>4)</sup>		8.9 <sup>11)</sup>							33.4 <sup>4)</sup>	
445	B																	56.6 <sup>3)</sup>		69.6 <sup>4)</sup>		8.9 <sup>11)</sup>							31.3 <sup>4)</sup>	
450	B																	56.6 <sup>3)</sup>		69.6 <sup>4)</sup>		8.9 <sup>11)</sup>							29.3 <sup>4)</sup>	

1) 12"; 2) 17"; 3) 22"; 4) 27"; 5) 32"; 6) 37"; 7) 42"; 8) 47"; 9) 52"; 10) 57"; 11) 62"

# Lifting capacities Forces de levage

SDWB



286,600 lbs -  
374,800 lbs



529,100 lbs - 617,300 lbs  
330,700 lbs - 463,000 lbs  
66,100 lbs - 264,600 lbs

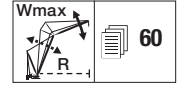

		S 256																										
		W 59		W 79		W 98		W 118		W 138		W 157		W 177		W 197		W 217		W 236		W 256		W 276				
		85	Wmax	87°/85	Wmax	87°/85	Wmax	87°/85	Wmax	87°/85	Wmax	87°/85	Wmax	87°/85	Wmax	87°/85	Wmax	87°/85	Wmax	87°/85	Wmax	87°/85	Wmax	87°/85	Wmax			
45	B			234.0°	234.0°																							
50	B	222.0	235.0 <sup>1)</sup>	228.0	228.0 <sup>1)</sup>	218.0	218.0 <sup>1)</sup>																					
55	B	204.0	216.0 <sup>1)</sup>	209.0	209.0 <sup>1)</sup>	201.0	201.0 <sup>1)</sup>	193.0	193.0 <sup>1)</sup>																			
60	B	188.0	199.0 <sup>1)</sup>	193.0	193.0 <sup>1)</sup>	186.0	186.0 <sup>1)</sup>	179.0	179.0 <sup>1)</sup>	170.0	170.0 <sup>1)</sup>																	
65	B	175.0	183.0 <sup>1)</sup>	180.0	180.0 <sup>1)</sup>	172.0	172.0 <sup>1)</sup>	166.0	166.0 <sup>1)</sup>	159.0	159.0 <sup>1)</sup>	150.0	150.0 <sup>1)</sup>															
70	B	163.0	172.0 <sup>1)</sup>	167.0	167.0 <sup>1)</sup>	161.0	161.0 <sup>1)</sup>	155.0	155.0 <sup>1)</sup>	149.0	149.0 <sup>1)</sup>	143.0	143.0 <sup>1)</sup>	133.0	133.0 <sup>1)</sup>													
75	B	152.0	162.0 <sup>1)</sup>	157.0	157.0 <sup>1)</sup>	150.0	150.0 <sup>1)</sup>	145.0	145.0 <sup>1)</sup>	139.0	139.0 <sup>1)</sup>	134.0	134.0 <sup>1)</sup>	129.0	129.0 <sup>1)</sup>	117.0	117.0 <sup>1)</sup>											
80	B	143.0	150.0 <sup>1)</sup>	147.0	147.0 <sup>1)</sup>	141.0	141.0 <sup>1)</sup>	136.0	136.0 <sup>1)</sup>	130.0	130.0 <sup>1)</sup>	125.0	125.0 <sup>1)</sup>	121.0	121.0 <sup>1)</sup>	114.0	114.0 <sup>1)</sup>	102.0	102.0 <sup>1)</sup>									
85	B	135.0	136.0 <sup>1)</sup>	139.0	139.0 <sup>1)</sup>	133.0	133.0 <sup>1)</sup>	128.0	128.0 <sup>1)</sup>	123.0	123.0 <sup>1)</sup>	118.0	118.0 <sup>1)</sup>	114.0	114.0 <sup>1)</sup>	110.0	110.0 <sup>1)</sup>	99.8	99.8 <sup>1)</sup>	88.6	88.6 <sup>1)</sup>							
90	B	125.0	125.0 <sup>1)</sup>	131.0	131.0 <sup>1)</sup>	126.0	126.0 <sup>1)</sup>	121.0	121.0 <sup>1)</sup>	116.0	116.0 <sup>1)</sup>	111.0	111.0 <sup>1)</sup>	107.0	107.0 <sup>1)</sup>	104.0	104.0 <sup>1)</sup>	97.9	97.9 <sup>1)</sup>	87.2	87.2 <sup>1)</sup>	77.6	77.6 <sup>1)</sup>					
95	B	115.0	115.0 <sup>1)</sup>	125.0	125.0 <sup>1)</sup>	119.0	119.0 <sup>1)</sup>	114.0	114.0 <sup>1)</sup>	109.0	109.0 <sup>1)</sup>	105.0	105.0 <sup>1)</sup>	101.0	101.0 <sup>1)</sup>	97.9	97.9 <sup>1)</sup>	93.5	93.5 <sup>1)</sup>	85.7	85.7 <sup>1)</sup>	76.4	76.4 <sup>1)</sup>	67.2	67.2 <sup>1)</sup>	67.2	67.2 <sup>1)</sup>	
100	B	106.0	110.0 <sup>1)</sup>	114.0	113.0 <sup>1)</sup>	108.0	108.0 <sup>1)</sup>	103.0	103.0 <sup>1)</sup>	99.0	99.0 <sup>1)</sup>	95.8	95.8 <sup>1)</sup>	92.4	92.4 <sup>1)</sup>	88.3	88.3 <sup>1)</sup>	84.0	84.0 <sup>1)</sup>	75.2	75.2 <sup>1)</sup>	66.2	66.2 <sup>1)</sup>	66.2	66.2 <sup>1)</sup>	66.2	66.2 <sup>1)</sup>	
105	B	95.7	102.0 <sup>1)</sup>	105.0	105.0 <sup>1)</sup>	100.0	100.0 <sup>1)</sup>	95.0	95.0 <sup>1)</sup>	91.1	91.1 <sup>1)</sup>	87.4	87.4 <sup>1)</sup>	83.4	83.4 <sup>1)</sup>	80.2	80.2 <sup>1)</sup>	74.1	74.1 <sup>1)</sup>	65.2	65.2 <sup>1)</sup>	65.2	65.2 <sup>1)</sup>	65.2	65.2 <sup>1)</sup>	65.2	65.2 <sup>1)</sup>	
110	B	86.1	97.1 <sup>1)</sup>	102.0	102.0 <sup>1)</sup>	97.8	97.8 <sup>1)</sup>	93.2	93.2 <sup>1)</sup>	89.0	89.0 <sup>1)</sup>	86.0	86.0 <sup>1)</sup>	82.8	82.8 <sup>1)</sup>	79.0	79.0 <sup>1)</sup>	75.9	75.9 <sup>1)</sup>	72.5	72.5 <sup>1)</sup>	64.3	64.3 <sup>1)</sup>	64.3	64.3 <sup>1)</sup>	64.3	64.3 <sup>1)</sup>	
115	B	79.4	89.6 <sup>1)</sup>	97.7	97.7 <sup>1)</sup>	93.2	93.2 <sup>1)</sup>	88.7	88.7 <sup>1)</sup>	84.6	84.6 <sup>1)</sup>	81.7	81.7 <sup>1)</sup>	78.6	78.6 <sup>1)</sup>	74.8	74.8 <sup>1)</sup>	71.8	71.8 <sup>1)</sup>	69.4	69.4 <sup>1)</sup>	63.4	63.4 <sup>1)</sup>	63.4	63.4 <sup>1)</sup>	63.4	63.4 <sup>1)</sup>	
120	B	72.8	82.1 <sup>1)</sup>	86.4	86.4 <sup>1)</sup>	82.0	82.0 <sup>1)</sup>	77.7	77.7 <sup>1)</sup>	73.7	73.7 <sup>1)</sup>	70.7	70.7 <sup>1)</sup>	67.7	67.7 <sup>1)</sup>	64.7	64.7 <sup>1)</sup>	61.7	61.7 <sup>1)</sup>	58.7	58.7 <sup>1)</sup>	52.7	52.7 <sup>1)</sup>	52.7	52.7 <sup>1)</sup>	52.7	52.7 <sup>1)</sup>	
125	B	66.2	74.6 <sup>1)</sup>	78.3	78.3 <sup>1)</sup>	74.0	74.0 <sup>1)</sup>	69.7	69.7 <sup>1)</sup>	65.4	65.4 <sup>1)</sup>	62.1	62.1 <sup>1)</sup>	58.8	58.8 <sup>1)</sup>	55.5	55.5 <sup>1)</sup>	52.2	52.2 <sup>1)</sup>	48.9	48.9 <sup>1)</sup>	42.9	42.9 <sup>1)</sup>	42.9	42.9 <sup>1)</sup>	42.9	42.9 <sup>1)</sup>	
130	B	59.5	67.8 <sup>1)</sup>	71.5	71.5 <sup>1)</sup>	67.2	67.2 <sup>1)</sup>	62.9	62.9 <sup>1)</sup>	58.6	58.6 <sup>1)</sup>	55.3	55.3 <sup>1)</sup>	52.0	52.0 <sup>1)</sup>	48.7	48.7 <sup>1)</sup>	45.4	45.4 <sup>1)</sup>	42.1	42.1 <sup>1)</sup>	36.1	36.1 <sup>1)</sup>	36.1	36.1 <sup>1)</sup>	36.1	36.1 <sup>1)</sup>	
135	B	54.0	62.4 <sup>1)</sup>	66.1	66.1 <sup>1)</sup>	61.8	61.8 <sup>1)</sup>	57.5	57.5 <sup>1)</sup>	53.2	53.2 <sup>1)</sup>	49.9	49.9 <sup>1)</sup>	46.6	46.6 <sup>1)</sup>	43.3	43.3 <sup>1)</sup>	40.0	40.0 <sup>1)</sup>	36.7	36.7 <sup>1)</sup>	30.7	30.7 <sup>1)</sup>	30.7	30.7 <sup>1)</sup>	30.7	30.7 <sup>1)</sup>	
140	B	49.0	57.1 <sup>1)</sup>	60.9	60.9 <sup>1)</sup>	56.6	56.6 <sup>1)</sup>	52.3	52.3 <sup>1)</sup>	48.0	48.0 <sup>1)</sup>	44.7	44.7 <sup>1)</sup>	41.4	41.4 <sup>1)</sup>	38.1	38.1 <sup>1)</sup>	34.8	34.8 <sup>1)</sup>	31.5	31.5 <sup>1)</sup>	25.5	25.5 <sup>1)</sup>	25.5	25.5 <sup>1)</sup>	25.5	25.5 <sup>1)</sup>	
145	B	45.3	51.8 <sup>1)</sup>	55.1	55.1 <sup>1)</sup>	50.8	50.8 <sup>1)</sup>	46.5	46.5 <sup>1)</sup>	42.2	42.2 <sup>1)</sup>	38.9	38.9 <sup>1)</sup>	35.6	35.6 <sup>1)</sup>	32.3	32.3 <sup>1)</sup>	29.0	29.0 <sup>1)</sup>	25.7	25.7 <sup>1)</sup>	19.7	19.7 <sup>1)</sup>	19.7	19.7 <sup>1)</sup>	19.7	19.7 <sup>1)</sup>	
150	B	41.0	46.5 <sup>1)</sup>	50.4	50.4 <sup>1)</sup>	46.1	46.1 <sup>1)</sup>	41.8	41.8 <sup>1)</sup>	37.5	37.5 <sup>1)</sup>	33.2	33.2 <sup>1)</sup>	29.9	29.9 <sup>1)</sup>	26.6	26.6 <sup>1)</sup>	23.3	23.3 <sup>1)</sup>	20.0	20.0 <sup>1)</sup>	14.0	14.0 <sup>1)</sup>	14.0	14.0 <sup>1)</sup>	14.0	14.0 <sup>1)</sup>	
155	B	36.7	42.2 <sup>1)</sup>	46.6	46.6 <sup>1)</sup>	42.3	42.3 <sup>1)</sup>	38.0	38.0 <sup>1)</sup>	33.7	33.7 <sup>1)</sup>	29.4	29.4 <sup>1)</sup>	25.1	25.1 <sup>1)</sup>	20.8	20.8 <sup>1)</sup>	16.5	16.5 <sup>1)</sup>	12.2	12.2 <sup>1)</sup>	6.2	6.2 <sup>1)</sup>	6.2	6.2 <sup>1)</sup>	6.2	6.2 <sup>1)</sup>	
160	B	32.4	38.5 <sup>1)</sup>	43.5	43.5 <sup>1)</sup>	39.2	39.2 <sup>1)</sup>	34.9	34.9 <sup>1)</sup>	30.6	30.6 <sup>1)</sup>	26.3	26.3 <sup>1)</sup>	22.0	22.0 <sup>1)</sup>	17.7	17.7 <sup>1)</sup>	13.4	13.4 <sup>1)</sup>	9.1	9.1 <sup>1)</sup>	3.1	3.1 <sup>1)</sup>	3.1	3.1 <sup>1)</sup>	3.1	3.1 <sup>1)</sup>	
165	B	28.1	34.8 <sup>1)</sup>	39.1	39.1 <sup>1)</sup>	34.8	34.8 <sup>1)</sup>	30.5	30.5 <sup>1)</sup>	26.2	26.2 <sup>1)</sup>	21.9	21.9 <sup>1)</sup>	17.6	17.6 <sup>1)</sup>	13.3	13.3 <sup>1)</sup>	9.0	9.0 <sup>1)</sup>	4.7	4.7 <sup>1)</sup>	0.7	0.7 <sup>1)</sup>	0.7	0.7 <sup>1)</sup>	0.7	0.7 <sup>1)</sup>	
170	B	23.8	31.2 <sup>1)</sup>	36.1	36.1 <sup>1)</sup>	31.8	31.8 <sup>1)</sup>	27.5	27.5 <sup>1)</sup>	23.2	23.2 <sup>1)</sup>	18.9	18.9 <sup>1)</sup>	14.6	14.6 <sup>1)</sup>	10.3	10.3 <sup>1)</sup>	6.0	6.0 <sup>1)</sup>	1.7	1.7 <sup>1)</sup>	0.7	0.7 <sup>1)</sup>	0.7	0.7 <sup>1)</sup>	0.7	0.7 <sup>1)</sup>	
175	B	19.5	27.5 <sup>1)</sup>	31.2	31.2 <sup>1)</sup>	26.9	26.9 <sup>1)</sup>	22.6	22.6 <sup>1)</sup>	18.3	18.3 <sup>1)</sup>	14.0	14.0 <sup>1)</sup>	9.7	9.7 <sup>1)</sup>	5.4	5.4 <sup>1)</sup>	1.1	1.1 <sup>1)</sup>	0.7	0.7 <sup>1)</sup>	0.7	0.7 <sup>1)</sup>	0.7	0.7 <sup>1)</sup>	0.7	0.7 <sup>1)</sup>	
180	B	18.5	23.9 <sup>1)</sup>	28.0	28.0 <sup>1)</sup>	23.7	23.7 <sup>1)</sup>	19.4	19.4 <sup>1)</sup>	15.1	15.1 <sup>1)</sup>	10.8	10.8 <sup>1)</sup>	6.5	6.5 <sup>1)</sup>	2.2	2.2 <sup>1)</sup>	0.7	0.7 <sup>1)</sup>	0.7	0.7 <sup>1)</sup>	0.7	0.7 <sup>1)</sup>	0.7	0.7 <sup>1)</sup>	0.7	0.7 <sup>1)</sup>	
185	B	17.9	20.2 <sup>1)</sup>	24.9	24.9 <sup>1)</sup>	20.6	20.6 <sup>1)</sup>	16.3	16.3 <sup>1)</sup>	12.0	12.0 <sup>1)</sup>	7.7	7.7 <sup>1)</sup>	3.4	3.4 <sup>1)</sup>	0.7	0.7 <sup>1)</sup>	0.7	0.7 <sup>1)</sup>	0.7	0.7 <sup>1)</sup>	0.7	0.7 <sup>1)</sup>	0.7	0.7 <sup>1)</sup>	0.7	0.7 <sup>1)</sup>	
190	B	17.2	16.6 <sup>1)</sup>	21.8	21.8 <sup>1)</sup>	17.5	17.5 <sup>1)</sup>	13.2	13.2 <sup>1)</sup>	8.9	8.9 <sup>1)</sup>	4.6	4.6 <sup>1)</sup>	0.7	0.7 <sup>1)</sup>	0.7	0.7 <sup>1)</sup>	0.7	0.7 <sup>1)</sup>	0.7	0.7 <sup>1)</sup>	0.7	0.7 <sup>1)</sup>	0.7	0.7 <sup>1)</sup>	0.7	0.7 <sup>1)</sup>	
195	B	16.6	12.9 <sup>1)</sup>	18.6	18.6 <sup>1)</sup>	14.3	14.3 <sup>1)</sup>	10.0	10.0 <sup>1)</sup>	5.7	5.7 <sup>1)</sup>	1.4	1.4 <sup>1)</sup>	0.7	0.7 <sup>1)</sup>	0.7	0.7 <sup>1)</sup>	0.7	0.7 <sup>1)</sup>	0.7	0.7 <sup>1)</sup>	0.7	0.7 <sup>1)</sup>	0.7	0.7 <sup>1)</sup>	0.7	0.7 <sup>1)</sup>	
200	B	16.0	15.5 <sup>1)</sup>	15.5	15.5 <sup>1)</sup>	11.2	11.2 <sup>1)</sup>	6.9	6.9 <sup>1)</sup>	2.6	2.6 <sup>1)</sup>	0.7	0.7 <sup>1)</sup>	0.7	0.7 <sup>1)</sup>	0.7	0.7 <sup>1)</sup>	0.7	0.7 <sup>1)</sup>	0.7	0.7 <sup>1)</sup>	0.7	0.7 <sup>1)</sup>	0.7	0.7 <sup>1)</sup>	0.7	0.7 <sup>1)</sup>	
205	B	15.3	12.3 <sup>1)</sup>	12.3	12.3 <sup>1)</sup>	7.9	7.9 <sup>1)</sup>	3.6	3.6 <sup>1)</sup>	1.1	1.1 <sup>1)</sup>	0.7	0.7 <sup>1)</sup>	0.7	0.7 <sup>1)</sup>	0.7	0.7 <sup>1)</sup>	0.7	0.7 <sup>1)</sup>	0.7	0.7 <sup>1)</sup>	0.7	0.7 <sup>1)</sup>	0.7	0.7 <sup>1)</sup>	0.7	0.7 <sup>1)</sup>	
210	B	14.7	9.2 <sup>1)</sup>	9.2	9.2 <sup>1)</sup>	4.9	4.9 <sup>1)</sup>	1.6	1.6 <sup>1)</sup>	0.7	0.7 <sup>1)</sup>	0.7	0.7 <sup>1)</sup>	0.7	0.7 <sup>1)</sup>	0.7	0.7 <sup>1)</sup>	0.7	0.7 <sup>1)</sup>	0.7	0.7 <sup>1)</sup>	0.7	0.7 <sup>1)</sup>	0.7	0.7 <sup>1)</sup>	0.7	0.7 <sup>1)</sup>	
215	B	14.1	6.1 <sup>1)</sup>	6.1	6.1 <sup>1)</sup>	2.9	2.9 <sup>1)</sup>	0.7	0.7 <sup>1)</sup>	0.7	0.7 <sup>1)</sup>	0.7	0.7 <sup>1)</sup>	0.7	0.7 <sup>1)</sup>	0.7	0.7 <sup>1)</sup>	0.7	0.7 <sup>1)</sup>	0.7	0.7 <sup>1)</sup>	0.7	0.7 <sup>1)</sup>	0.7	0.7 <sup>1)</sup>	0.7	0.7 <sup>1)</sup>	
220	B	13.6	9.1 <sup>1)</sup>	9.1	9.1 <sup>1)</sup>	4.0	4.0 <sup>1)</sup>	1.3	1.3 <sup>1)</sup>	0.7	0.7 <sup>1)</sup>	0.7	0.7 <sup>1)</sup>	0.7	0.7 <sup>1)</sup>	0.7	0.7 <sup>1)</sup>	0.7	0.7 <sup>1)</sup>	0.7	0.7 <sup>1)</sup>	0.7	0.7 <sup>1)</sup>	0.7	0.7 <sup>1)</sup>	0.7	0.7 <sup>1)</sup>	
225	B	13.1	17.7 <sup>1)</sup>	17.7	17.7 <sup>1)</sup>	10.0	10.0 <sup>1)</sup>	3.3	3.3 <sup>1)</sup>	1.1	1.1 <sup>1)</sup>	0.7	0.7 <sup>1)</sup>	0.7	0.7 <sup>1)</sup>	0.7	0.7 <sup>1)</sup>	0.7	0.7 <sup>1)</sup>	0.7	0.7 <sup>1)</sup>	0.7	0.7 <sup>1)</sup>	0.7	0.7 <sup>1)</sup>	0.7	0.7 <sup>1)</sup>	
230	B	12.7	15.2 <sup>1)</sup>	15.2	15.2 <sup>1)</sup>	8.0	8.0 <sup>1)</sup>	2.7	2.7 <sup>1)</sup> </																			

# Lifting capacities Forces de levage

**SDWB**



286,600 lbs -  
374,800 lbs



529,100 lbs - 617,300 lbs  
330,700 lbs - 463,000 lbs  
66,100 lbs - 264,600 lbs



**60**

		S 256																							
ft	B	W 59		W 79		W 98		W 118		W 138		W 157		W 177		W 197		W 217		W 236		W 256		W 276	
		85	Wmax	87*/85	Wmax	87*/85	Wmax	87*/85	Wmax	87*/85	Wmax	87*/85	Wmax	87*/85	Wmax	87*/85	Wmax	87*/85	Wmax	87*/85	Wmax	87*/85	Wmax	87*/85	Wmax
260	B			104.0 <sup>1)</sup>		106.0 <sup>2)</sup>		108.0 <sup>3)</sup>		105.0 <sup>4)</sup>		97.1 <sup>5)</sup>		89.9 <sup>6)</sup>		82.2 <sup>7)</sup>		73.1 <sup>8)</sup>	14.7	14.7	16.1*	16.1*	13.8*	13.8*	
265	B			100.0 <sup>1)</sup>		103.0 <sup>2)</sup>		104.0 <sup>3)</sup>		102.0 <sup>4)</sup>		96.7 <sup>5)</sup>		88.2 <sup>6)</sup>		81.3 <sup>7)</sup>		72.5 <sup>8)</sup>	47.3	65.1 <sup>9)</sup>	42.7	57.5 <sup>10)</sup>	38.6	50.2 <sup>11)</sup>	
270	B																		14.2	14.2	15.4*	15.4*	13.0*	13.0*	
275	B					99.1 <sup>1)</sup>		101.0 <sup>2)</sup>		99.4 <sup>3)</sup>		96.5 <sup>4)</sup>		86.9 <sup>5)</sup>		80.0 <sup>6)</sup>		71.9 <sup>7)</sup>	14.7	14.7	14.7*	14.7*	12.3*	12.3*	
280	B					95.5 <sup>1)</sup>		97.2 <sup>2)</sup>		96.8 <sup>3)</sup>		94.7 <sup>4)</sup>		85.3 <sup>5)</sup>		79.2 <sup>6)</sup>		71.3 <sup>7)</sup>	14.1*	14.1*	14.1*	14.1*	11.5*	11.5*	
285	B					91.9 <sup>1)</sup>		94.0 <sup>2)</sup>		94.2 <sup>3)</sup>		92.4 <sup>4)</sup>		83.7 <sup>5)</sup>		77.8 <sup>6)</sup>		70.4 <sup>7)</sup>	9.7	9.7	9.7	9.7	10.9*	10.9*	
290	B					88.3 <sup>1)</sup>		90.9 <sup>2)</sup>		91.6 <sup>3)</sup>		90.2 <sup>4)</sup>		82.9 <sup>5)</sup>		76.7 <sup>6)</sup>		69.7 <sup>7)</sup>	14.1*	14.1*	14.1*	14.1*	11.5*	11.5*	
295	B							87.7 <sup>1)</sup>		89.0 <sup>2)</sup>		87.9 <sup>3)</sup>		82.7 <sup>4)</sup>		75.3 <sup>5)</sup>		69.2 <sup>6)</sup>	9.3	9.3	9.3	9.3	10.2*	10.2*	
300	B							84.6 <sup>1)</sup>		85.7 <sup>2)</sup>		85.7 <sup>3)</sup>		81.1 <sup>4)</sup>		74.2 <sup>5)</sup>		67.9 <sup>6)</sup>	38.4	38.4	38.4	38.4	34.0	48.4 <sup>7)</sup>	
305	B							81.4 <sup>1)</sup>		82.8 <sup>2)</sup>		83.5 <sup>3)</sup>		79.4 <sup>4)</sup>		72.8 <sup>5)</sup>		66.9 <sup>6)</sup>	9.7	9.7	9.7	9.7	34.0	48.4 <sup>7)</sup>	
310	B							78.3 <sup>1)</sup>		80.0 <sup>2)</sup>		81.3 <sup>3)</sup>		77.7 <sup>4)</sup>		72.6 <sup>5)</sup>		65.7 <sup>6)</sup>	9.3	9.3	9.3	9.3	34.0	48.4 <sup>7)</sup>	
315	B									77.2 <sup>1)</sup>		79.0 <sup>2)</sup>		76.1 <sup>3)</sup>		72.5 <sup>4)</sup>		64.9 <sup>5)</sup>	9.3	9.3	9.3	9.3	34.0	48.4 <sup>7)</sup>	
320	B									74.4 <sup>1)</sup>		75.8 <sup>2)</sup>		74.4 <sup>3)</sup>		70.8 <sup>4)</sup>		63.7 <sup>5)</sup>	9.3	9.3	9.3	9.3	34.0	48.4 <sup>7)</sup>	
325	B									71.6 <sup>1)</sup>		73.3 <sup>2)</sup>		72.7 <sup>3)</sup>		69.3 <sup>4)</sup>		63.0 <sup>5)</sup>	9.3	9.3	9.3	9.3	34.0	48.4 <sup>7)</sup>	
330	B									68.7 <sup>1)</sup>		70.8 <sup>2)</sup>		71.0 <sup>3)</sup>		67.8 <sup>4)</sup>		62.9 <sup>5)</sup>	9.3	9.3	9.3	9.3	34.0	48.4 <sup>7)</sup>	
335	B											68.3 <sup>1)</sup>		69.3 <sup>2)</sup>		66.4 <sup>3)</sup>		62.8 <sup>4)</sup>	9.3	9.3	9.3	9.3	34.0	48.4 <sup>7)</sup>	
340	B											65.8 <sup>1)</sup>		65.9 <sup>2)</sup>		64.9 <sup>3)</sup>		61.1 <sup>4)</sup>	9.3	9.3	9.3	9.3	34.0	48.4 <sup>7)</sup>	
345	B											63.2 <sup>1)</sup>		63.9 <sup>2)</sup>		63.4 <sup>3)</sup>		59.8 <sup>4)</sup>	9.3	9.3	9.3	9.3	34.0	48.4 <sup>7)</sup>	
350	B											60.7 <sup>1)</sup>		61.8 <sup>2)</sup>		61.9 <sup>3)</sup>		58.5 <sup>4)</sup>	9.3	9.3	9.3	9.3	34.0	48.4 <sup>7)</sup>	
355	B												59.7 <sup>1)</sup>		60.4 <sup>2)</sup>		57.2 <sup>3)</sup>	9.3	9.3	9.3	9.3	34.0	48.4 <sup>7)</sup>		
360	B												57.6 <sup>1)</sup>		57.4 <sup>2)</sup>		55.9 <sup>3)</sup>	9.3	9.3	9.3	9.3	34.0	48.4 <sup>7)</sup>		
365	B												55.5 <sup>1)</sup>		55.7 <sup>2)</sup>		54.5 <sup>3)</sup>	9.3	9.3	9.3	9.3	34.0	48.4 <sup>7)</sup>		
370	B												53.4 <sup>1)</sup>		54.0 <sup>2)</sup>		53.2 <sup>3)</sup>	9.3	9.3	9.3	9.3	34.0	48.4 <sup>7)</sup>		
375	B													52.3 <sup>1)</sup>		51.9 <sup>2)</sup>		49.5 <sup>3)</sup>	9.3	9.3	9.3	9.3	34.0	48.4 <sup>7)</sup>	
380	B													50.6 <sup>1)</sup>		49.3 <sup>2)</sup>		48.4 <sup>3)</sup>	9.3	9.3	9.3	9.3	34.0	48.4 <sup>7)</sup>	
385	B													48.9 <sup>1)</sup>		47.9 <sup>2)</sup>		47.2 <sup>3)</sup>	9.3	9.3	9.3	9.3	34.0	48.4 <sup>7)</sup>	
390	B													47.2 <sup>1)</sup>		46.5 <sup>2)</sup>		46.0 <sup>3)</sup>	9.3	9.3	9.3	9.3	34.0	48.4 <sup>7)</sup>	
395	B														45.1 <sup>1)</sup>		44.8 <sup>2)</sup>	9.3	9.3	9.3	9.3	34.0	48.4 <sup>7)</sup>		
400	B														43.7 <sup>1)</sup>		42.5 <sup>2)</sup>	9.3	9.3	9.3	9.3	34.0	48.4 <sup>7)</sup>		
405	B														42.3 <sup>1)</sup>		41.3 <sup>2)</sup>	9.3	9.3	9.3	9.3	34.0	48.4 <sup>7)</sup>		
410	B														40.9 <sup>1)</sup>		40.0 <sup>2)</sup>	9.3	9.3	9.3	9.3	34.0	48.4 <sup>7)</sup>		
415	B																38.8 <sup>1)</sup>	9.3	9.3	9.3	9.3	34.0	48.4 <sup>7)</sup>		
420	B																37.6 <sup>1)</sup>	9.3	9.3	9.3	9.3	34.0	48.4 <sup>7)</sup>		
425	B																36.3 <sup>1)</sup>	9.3	9.3	9.3	9.3	34.0	48.4 <sup>7)</sup>		
430	B																35.1 <sup>1)</sup>	9.3	9.3	9.3	9.3	34.0	48.4 <sup>7)</sup>		
435	B																	31.8 <sup>1)</sup>	9.3	9.3	9.3	9.3	34.0	48.4 <sup>7)</sup>	
440	B																	30.6 <sup>1)</sup>	9.3	9.3	9.3	9.3	34.0	48.4 <sup>7)</sup>	
445	B																	29.4 <sup>1)</sup>	9.3	9.3	9.3	9.3	34.0	48.4 <sup>7)</sup>	
450	B																	27.9 <sup>1)</sup>	9.3	9.3	9.3	9.3	34.0	48.4 <sup>7)</sup>	
455	B																							22.6 <sup>1)</sup>	
460	B																							20.6 <sup>1)</sup>	
465	B																							16.7 <sup>1)</sup>	

1) 12°; 2) 17°; 3) 22°; 4) 27°; 5) 32°; 6) 37°; 7) 42°; 8) 47°; 9) 52°; 10) 57°; 11) 62°



# Lifting capacities Forces de levage

SDWB



286,600 lbs -  
374,800 lbs



529,100 lbs - 617,300 lbs  
330,700 lbs - 463,000 lbs  
66,100 lbs - 264,600 lbs

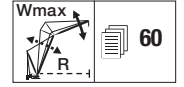

		S 276																									
		W 59		W 79		W 98		W 118		W 138		W 157		W 177		W 197		W 217		W 236		W 256		W 276			
		85	Wmax	87°/85	Wmax	87°/85	Wmax	87°/85	Wmax	87°/85	Wmax	87°/85	Wmax	87°/85	Wmax	87°/85	Wmax	87°/85	Wmax	87°/85	Wmax	87°/85	Wmax	87°/85	Wmax		
45	B			224.0°	224.0°																						
50	B			224.0°	224.0°																						
55	B			218.0°	218.0°	196.0°	196.0°																				
60	B	196.0	209.0 <sup>1)</sup>	201.0°	201.0°	191.0°	191.0°	171.0°	171.0°																		
65	B	181.0	193.0 <sup>1)</sup>	186.0°	186.0°	178.0°	178.0°	167.0°	167.0°	151.0°	151.0°																
70	B	168.0	178.0 <sup>1)</sup>	173.0°	173.0°	166.0°	166.0°	160.0°	160.0°	148.0°	148.0°	133.0°	133.0°														
75	B	157.0	168.0 <sup>1)</sup>	161.0°	161.0°	155.0°	155.0°	149.0°	149.0°	143.0°	143.0°	130.0°	130.0°	117.0°	117.0°												
80	B	147.0	155.0 <sup>1)</sup>	151.0°	151.0°	145.0°	145.0°	139.0°	139.0°	134.0°	134.0°	127.0°	127.0°	115.0°	115.0°	103.0°	103.0°										
85	B	130.0	133.0 <sup>1)</sup>	134.0°	134.0°	128.0°	128.0°	123.0°	123.0°	118.0°	118.0°	113.0°	113.0°	109.0°	109.0°	98.6°	98.6°	87.7°	87.7°	77.9°	77.9°						
90	B	123.0	123.0 <sup>1)</sup>	127.0°	127.0°	121.0°	121.0°	116.0°	116.0°	111.0°	111.0°	107.0°	107.0°	103.0°	103.0°	96.5°	96.5°	86.0°	86.0°	76.6°	76.6°	68.1°	68.1°				
95	B	112.0 <sup>1)</sup>	120.0 <sup>1)</sup>	120.0°	120.0°	115.0°	115.0°	110.0°	110.0°	105.0°	105.0°	101.0°	101.0°	97.4°	97.4°	93.3°	93.3°	84.4°	84.4°	75.2°	75.2°	67.0°	67.0°	58.8°	58.8°		
100	B	103.0 <sup>1)</sup>	115.0 <sup>1)</sup>	115.0°	115.0°	109.0°	109.0°	104.0°	104.0°	99.5°	99.5°	95.1°	95.1°	92.1°	92.1°	88.6°	88.6°	82.5°	82.5°	73.8°	73.8°	65.9°	65.9°	57.8°	57.9°		
105	B	93.8 <sup>1)</sup>	101.0 <sup>1)</sup>	101.0°	101.0°	103.0°	103.0°	99.1°	94.4°	94.4°	94.4°	90.1°	90.1°	87.2°	87.2°	83.9°	83.9°	79.4°	79.4°	72.3°	72.3°	64.6°	64.6°	56.8°	57.0°		
110	B	84.6 <sup>1)</sup>	96.0 <sup>1)</sup>	96.0°	96.0°	98.6°	98.6°	94.2°	94.2°	89.7°	89.7°	85.5°	85.5°	82.6°	82.6°	79.5°	79.5°	75.6°	75.6°	70.7°	70.7°	63.3°	63.3°	55.8°	56.1°		
115	B	76.5 <sup>1)</sup>	86.6 <sup>1)</sup>	86.6°	86.6°	94.2°	94.2°	89.8°	89.8°	85.3°	85.3°	81.2°	81.2°	78.4°	78.4°	75.4°	75.4°	71.6°	71.6°	68.6°	68.6°	62.0°	62.0°	55.5°	55.5°		
120	B	70.4 <sup>1)</sup>	79.5 <sup>1)</sup>	79.5°	79.5°	90.5°	90.5°	85.7°	85.7°	81.3°	81.3°	77.3°	77.3°	74.6°	74.6°	71.6°	71.6°	67.8°	67.8°	65.0°	65.0°	60.6°	60.6°	53.7°	53.7°		
125	B	64.2 <sup>1)</sup>	72.4 <sup>1)</sup>	72.4°	72.4°	79.0	79.0	82.0°	82.0°	77.6°	77.6°	73.6°	73.6°	71.0°	71.0°	68.1°	68.1°	64.4°	64.4°	61.6°	61.6°	58.1°	58.1°	52.4°	52.4°		
130	B	58.1 <sup>1)</sup>	65.3 <sup>1)</sup>	65.3°	65.3°	76.0	76.0	78.5°	78.5°	74.1°	74.1°	70.2°	70.2°	67.6°	67.6°	64.8°	64.8°	61.2°	61.2°	58.4°	58.4°	55.2°	55.2°	50.7°	50.7°		
135	B	52.0 <sup>1)</sup>	59.5 <sup>1)</sup>	59.5°	59.5°	67.1 <sup>1)</sup>	67.1 <sup>1)</sup>	75.4°	75.4°	70.9°	70.9°	67.0°	67.0°	64.5°	64.5°	61.7°	61.7°	58.2°	58.2°	55.5°	55.5°	52.4°	52.4°	48.2°	48.2°		
140	B	46.8 <sup>1)</sup>	54.5 <sup>1)</sup>	54.5°	54.5°	61.3 <sup>1)</sup>	61.3 <sup>1)</sup>	72.9°	72.9°	67.9°	67.9°	64.1°	64.1°	61.5°	61.5°	58.8°	58.8°	55.3°	55.3°	52.7°	52.7°	49.8°	49.8°	45.7°	45.7°		
145	B	42.8 <sup>1)</sup>	49.5 <sup>1)</sup>	49.5°	49.5°	55.6 <sup>1)</sup>	55.6 <sup>1)</sup>	63.1	63.1	65.2°	65.2°	61.3°	61.3°	58.8°	58.8°	56.1°	56.1°	52.7°	52.7°	50.1°	50.1°	47.2°	47.2°	43.3°	43.3°		
150	B	38.9 <sup>1)</sup>	44.5 <sup>1)</sup>	44.5°	44.5°	49.9 <sup>1)</sup>	49.9 <sup>1)</sup>	57.0 <sup>1)</sup>	57.0 <sup>1)</sup>	62.6°	62.6°	58.7°	58.7°	56.2°	56.2°	53.6°	53.6°	50.2°	50.2°	47.6°	47.6°	44.9°	44.9°	41.1°	41.1°		
155	B	34.9 <sup>1)</sup>	39.5 <sup>1)</sup>	39.5°	39.5°	44.0 <sup>1)</sup>	44.0 <sup>1)</sup>	48.0 <sup>1)</sup>	48.0 <sup>1)</sup>	52.1°	52.1°	48.4°	48.4°	46.1°	46.1°	43.6°	43.6°	40.3°	40.3°	37.7°	37.7°	34.9°	34.9°	31.1°	31.1°		
160	B	31.0 <sup>1)</sup>	35.5 <sup>1)</sup>	35.5°	35.5°	41.3 <sup>1)</sup>	41.3 <sup>1)</sup>	47.5 <sup>1)</sup>	47.5 <sup>1)</sup>	51.9°	51.9°	48.1°	48.1°	45.5°	45.5°	43.0°	43.0°	40.0°	40.0°	37.9°	37.9°	35.3°	35.3°	31.5°	31.5°		
165	B	27.0 <sup>1)</sup>	32.1 <sup>1)</sup>	32.1°	32.1°	37.2 <sup>1)</sup>	37.2 <sup>1)</sup>	42.8 <sup>1)</sup>	42.8 <sup>1)</sup>	50.0	50.0	45.9°	45.9°	43.5°	43.5°	41.1°	41.1°	38.5°	38.5°	36.0°	36.0°	33.1°	33.1°	29.5°	29.5°		
170	B	23.1 <sup>1)</sup>	28.8 <sup>1)</sup>	28.8°	28.8°	33.0 <sup>1)</sup>	33.0 <sup>1)</sup>	38.2 <sup>1)</sup>	38.2 <sup>1)</sup>	43.9 <sup>1)</sup>	43.9 <sup>1)</sup>	40.0°	40.0°	37.4°	37.4°	34.8°	34.8°	31.5°	31.5°	28.8°	28.8°	25.8°	25.8°	22.7°	22.7°		
175	B	19.1 <sup>1)</sup>	25.4 <sup>1)</sup>	25.4°	25.4°	28.8 <sup>1)</sup>	28.8 <sup>1)</sup>	34.7 <sup>1)</sup>	34.7 <sup>1)</sup>	39.9 <sup>1)</sup>	39.9 <sup>1)</sup>	37.3°	37.3°	34.9°	34.9°	32.3°	32.3°	29.3°	29.3°	26.4°	26.4°	23.4°	23.4°	20.4°	20.4°		
180	B	15.2 <sup>1)</sup>	22.0 <sup>1)</sup>	22.0°	22.0°	25.2 <sup>1)</sup>	25.2 <sup>1)</sup>	31.1 <sup>1)</sup>	31.1 <sup>1)</sup>	35.9 <sup>1)</sup>	35.9 <sup>1)</sup>	33.7°	33.7°	31.1°	31.1°	28.5°	28.5°	25.5°	25.5°	22.6°	22.6°	19.7°	19.7°	16.7°	16.7°		
185	B	16.7 <sup>1)</sup>	18.6 <sup>1)</sup>	18.6°	18.6°	21.5 <sup>1)</sup>	21.5 <sup>1)</sup>	27.5 <sup>1)</sup>	27.5 <sup>1)</sup>	31.9 <sup>1)</sup>	31.9 <sup>1)</sup>	29.1°	29.1°	26.2°	26.2°	23.3°	23.3°	20.3°	20.3°	17.4°	17.4°	14.5°	14.5°	11.6°	11.6°		
190	B	16.0 <sup>1)</sup>	17.9 <sup>1)</sup>	17.9°	17.9°	20.8 <sup>1)</sup>	20.8 <sup>1)</sup>	26.8 <sup>1)</sup>	26.8 <sup>1)</sup>	30.8 <sup>1)</sup>	30.8 <sup>1)</sup>	28.0°	28.0°	25.1°	25.1°	22.2°	22.2°	19.2°	19.2°	16.3°	16.3°	13.4°	13.4°	10.5°	10.5°		
195	B	15.6 <sup>1)</sup>	17.5 <sup>1)</sup>	17.5°	17.5°	20.4 <sup>1)</sup>	20.4 <sup>1)</sup>	26.4 <sup>1)</sup>	26.4 <sup>1)</sup>	30.4 <sup>1)</sup>	30.4 <sup>1)</sup>	27.6°	27.6°	24.7°	24.7°	21.8°	21.8°	18.8°	18.8°	15.9°	15.9°	13.0°	13.0°	10.1°	10.1°		
200	B	15.1 <sup>1)</sup>	17.0 <sup>1)</sup>	17.0°	17.0°	20.0 <sup>1)</sup>	20.0 <sup>1)</sup>	26.0 <sup>1)</sup>	26.0 <sup>1)</sup>	30.0 <sup>1)</sup>	30.0 <sup>1)</sup>	27.2°	27.2°	24.3°	24.3°	21.4°	21.4°	18.4°	18.4°	15.5°	15.5°	12.6°	12.6°	9.7°	9.7°		
205	B	14.7 <sup>1)</sup>	16.6 <sup>1)</sup>	16.6°	16.6°	19.6 <sup>1)</sup>	19.6 <sup>1)</sup>	25.6 <sup>1)</sup>	25.6 <sup>1)</sup>	29.6 <sup>1)</sup>	29.6 <sup>1)</sup>	26.8°	26.8°	23.9°	23.9°	21.0°	21.0°	18.0°	18.0°	15.1°	15.1°	12.2°	12.2°	9.3°	9.3°		
210	B	14.2 <sup>1)</sup>	16.1 <sup>1)</sup>	16.1°	16.1°	19.1 <sup>1)</sup>	19.1 <sup>1)</sup>	25.1 <sup>1)</sup>	25.1 <sup>1)</sup>	29.1 <sup>1)</sup>	29.1 <sup>1)</sup>	26.4°	26.4°	23.5°	23.5°	20.6°	20.6°	17.6°	17.6°	14.7°	14.7°	11.8°	11.8°	8.9°	8.9°		
215	B	13.8 <sup>1)</sup>	15.6 <sup>1)</sup>	15.6°	15.6°	18.7 <sup>1)</sup>	18.7 <sup>1)</sup>	24.7 <sup>1)</sup>	24.7 <sup>1)</sup>	28.7 <sup>1)</sup>	28.7 <sup>1)</sup>	26.0°	26.0°	23.1°	23.1°	20.2°	20.2°	17.2°	17.2°	14.3°	14.3°	11.4°	11.4°	8.5°	8.5°		
220	B	13.4 <sup>1)</sup>	15.2 <sup>1)</sup>	15.2°	15.2°	18.3 <sup>1)</sup>	18.3 <sup>1)</sup>	24.3 <sup>1)</sup>	24.3 <sup>1)</sup>	28.3 <sup>1)</sup>	28.3 <sup>1)</sup>	25.6°	25.6°	22.7°	22.7°	19.8°	19.8°	16.8°	16.8°	13.9°	13.9°	11.0°	11.0°	8.1°	8.1°		
225	B	12.9 <sup>1)</sup>	14.7 <sup>1)</sup>	14.7°	14.7°	17.8 <sup>1)</sup>	17.8 <sup>1)</sup>	23.8 <sup>1)</sup>	23.8 <sup>1)</sup>	27.8 <sup>1)</sup>	27.8 <sup>1)</sup>	25.2°	25.2°	22.3°	22.3°	19.4°	19.4°	16.4°	16.4°	13.5°	13.5°	10.6°	10.6°	7.7°	7.7°		
230	B	12.5 <sup>1)</sup>	14.3 <sup>1)</sup>	14.3°	14.3°	17.4 <sup>1)</sup>	17.4 <sup>1)</sup>	23.4 <sup>1)</sup>	23.4 <sup>1)</sup>	27.4 <sup>1)</sup>	27.4 <sup>1)</sup>	24.8°	24.8°	21.9°	21.9°	18.9°	18.9°	16.0°	16.0°	13.1°	13.1°	10.2°	10.2°	7.3°	7.3°		
235	B	12.1 <sup>1)</sup>	13.9 <sup>1)</sup>	13.9°	13.9°	17.0 <sup>1)</sup>	17.0 <sup>1)</sup>	23.0 <sup>1)</sup>	23.0 <sup>1)</sup>	27.0 <sup>1)</sup>	27.0 <sup>1)</sup>	24.4°	24.4°	21.5°	21.5°	18.5°	18.5°	15.6°	15.6°	12.7°	12.7°	9.8°	9.8°	6.9°	6.9°		
240	B	11.7 <sup>1)</sup>	13.5 <sup>1)</sup>	13.5°	13.5°	16.6 <sup>1)</sup>	16.6 <sup>1)</sup>	22.6 <sup>1)</sup>	22.6 <sup>1)</sup>	26.6 <sup>1)</sup>	26.6 <sup>1)</sup>	24.0°	24.0°	21.1°	21.1°	18.1°	18.1°	15.2°	15.2°	12.3°	12.3°	9.4°	9.4°	6.5°	6.5°		
245	B	11.2 <sup>1)</sup>	13.1 <sup>1)</sup>	13.1°	13.1°	16.2 <sup>1)</sup>	16.2 <sup>1)</sup>	22.2 <sup>1)</sup>	22.2 <sup>1)</sup>	26.2 <sup>1)</sup>	26.2 <sup>1)</sup>	23.6°	23.6°	20.7°	20.7°	17.7°	17.7°	14.8°	14.8°	11.9°	11.9°	9.0°	9.0°	6.1°	6.1°		
250	B	10.8 <sup>1)</sup>	12.7 <sup>1)</sup>	12.7°	12.7°	15.8 <sup>1)</sup>	15.8 <sup>1)</sup>	21.8 <sup>1)</sup>	21.8 <sup>1)</sup>	25.8 <sup>1)</sup>	25.8 <sup>1)</sup>	23															

# Lifting capacities Forces de levage

**SDWB**



286,600 lbs –  
374,800 lbs



529,100 lbs – 617,300 lbs  
330,700 lbs – 463,000 lbs  
66,100 lbs – 264,600 lbs



**60**

		S 276																									
ft	B	W 59		W 79		W 98		W 118		W 138		W 157		W 177		W 197		W 217		W 236		W 256		W 276			
		85	Wmax	87°/85	Wmax	87°/85	Wmax	87°/85	Wmax	87°/85	Wmax	87°/85	Wmax	87°/85	Wmax	87°/85	Wmax	87°/85	Wmax	87°/85	Wmax	87°/85	Wmax	87°/85	Wmax		
265	B			99.1 <sup>1)</sup>		96.6 <sup>2)</sup>		91.6 <sup>3)</sup>		86.0 <sup>4)</sup>		78.9 <sup>5)</sup>		72.7 <sup>6)</sup>		66.2 <sup>7)</sup>		59.1 <sup>8)</sup>		12.2	12.2	13.9 <sup>9)</sup>	13.9 <sup>9)</sup>	11.6 <sup>10)</sup>	11.6 <sup>10)</sup>		
270	B			95.5 <sup>1)</sup>		93.1 <sup>2)</sup>		89.3 <sup>3)</sup>		84.0 <sup>4)</sup>		78.3 <sup>5)</sup>		71.5 <sup>6)</sup>		65.5 <sup>7)</sup>		58.4 <sup>8)</sup>		51.9 <sup>9)</sup>	37.6	33.3	33.2	33.2	29.5	40.1 <sup>11)</sup>	
275	B			92.0 <sup>1)</sup>		90.5 <sup>2)</sup>		87.1 <sup>3)</sup>		81.9 <sup>4)</sup>		77.9 <sup>5)</sup>		70.1 <sup>6)</sup>		64.3 <sup>7)</sup>		57.5 <sup>8)</sup>		51.3 <sup>9)</sup>	31.6	31.6	31.6	31.6	28.6	39.7 <sup>11)</sup>	
280	B			88.4 <sup>1)</sup>		87.9 <sup>2)</sup>		84.8 <sup>3)</sup>		79.9 <sup>4)</sup>		77.3 <sup>5)</sup>		68.8 <sup>6)</sup>		63.5 <sup>7)</sup>		56.8 <sup>8)</sup>		50.7 <sup>9)</sup>	30.9	30.9	30.9	30.9	27.8	39.3 <sup>11)</sup>	
285	B					85.3 <sup>2)</sup>		81.5 <sup>3)</sup>		77.8 <sup>4)</sup>		75.3 <sup>5)</sup>		67.5 <sup>6)</sup>		62.5 <sup>7)</sup>		56.2 <sup>8)</sup>		50.2 <sup>9)</sup>	30.3	30.3	30.3	30.3	27.0	38.9 <sup>11)</sup>	
290	B					82.7 <sup>2)</sup>		79.4 <sup>3)</sup>		75.8 <sup>4)</sup>		73.4 <sup>5)</sup>		66.5 <sup>6)</sup>		61.3 <sup>7)</sup>		55.1 <sup>8)</sup>		49.7 <sup>9)</sup>	27.5	27.5	27.5	27.5	26.2	38.5 <sup>11)</sup>	
295	B					80.1 <sup>2)</sup>		77.3 <sup>3)</sup>		73.7 <sup>4)</sup>		71.4 <sup>5)</sup>		66.2 <sup>6)</sup>		60.3 <sup>7)</sup>		54.6 <sup>8)</sup>		49.1 <sup>9)</sup>	25.4	25.4	25.4	25.4	25.4	38.1 <sup>11)</sup>	
300	B					77.5 <sup>2)</sup>		75.1 <sup>3)</sup>		71.7 <sup>4)</sup>		69.4 <sup>5)</sup>		65.9 <sup>6)</sup>		59.3 <sup>7)</sup>		53.8 <sup>8)</sup>		48.6 <sup>9)</sup>	24.8	24.8	24.8	24.8	24.8	37.7 <sup>11)</sup>	
305	B							73.0 <sup>3)</sup>		69.1 <sup>4)</sup>		67.5 <sup>5)</sup>		63.8 <sup>6)</sup>		58.1 <sup>7)</sup>		52.7 <sup>8)</sup>		47.5 <sup>9)</sup>	24.3	24.3	24.3	24.3	24.3	37.4 <sup>11)</sup>	
310	B							70.9 <sup>3)</sup>		67.2 <sup>4)</sup>		65.5 <sup>5)</sup>		62.2 <sup>6)</sup>		57.6 <sup>7)</sup>		52.0 <sup>8)</sup>		47.0 <sup>9)</sup>	23.9	23.9	23.9	23.9	23.9	37.0 <sup>11)</sup>	
315	B							68.8 <sup>3)</sup>		65.3 <sup>4)</sup>		63.5 <sup>5)</sup>		60.7 <sup>6)</sup>		57.3 <sup>7)</sup>		50.8 <sup>8)</sup>		46.3 <sup>9)</sup>	23.9	23.9	23.9	23.9	23.9	36.7 <sup>11)</sup>	
320	B							66.6 <sup>3)</sup>		63.5 <sup>4)</sup>		61.6 <sup>5)</sup>		59.1 <sup>6)</sup>		57.1 <sup>7)</sup>		50.1 <sup>8)</sup>		45.4 <sup>9)</sup>	23.9	23.9	23.9	23.9	23.9	36.3 <sup>11)</sup>	
325	B									61.6 <sup>3)</sup>		58.7 <sup>4)</sup>		57.6 <sup>5)</sup>		55.1 <sup>6)</sup>		49.4 <sup>7)</sup>		45.0 <sup>8)</sup>	23.9	23.9	23.9	23.9	23.9	36.0 <sup>11)</sup>	
330	B									59.7 <sup>3)</sup>		57.0 <sup>4)</sup>		56.0 <sup>5)</sup>		53.7 <sup>6)</sup>		49.1 <sup>7)</sup>		44.0 <sup>8)</sup>	23.9	23.9	23.9	23.9	23.9	35.6 <sup>11)</sup>	
335	B									57.8 <sup>3)</sup>		55.4 <sup>4)</sup>		54.4 <sup>5)</sup>		52.3 <sup>6)</sup>		48.9 <sup>7)</sup>		43.5 <sup>8)</sup>	23.9	23.9	23.9	23.9	23.9	35.2 <sup>11)</sup>	
340	B									56.0 <sup>3)</sup>		53.8 <sup>4)</sup>		52.9 <sup>5)</sup>		50.9 <sup>6)</sup>		48.7 <sup>7)</sup>		42.5 <sup>8)</sup>	23.9	23.9	23.9	23.9	23.9	34.6 <sup>11)</sup>	
345	B											52.2 <sup>3)</sup>		50.2 <sup>4)</sup>		49.5 <sup>5)</sup>		46.7 <sup>6)</sup>		42.2 <sup>7)</sup>	23.9	23.9	23.9	23.9	23.9	34.3 <sup>11)</sup>	
350	B											50.5 <sup>3)</sup>		48.7 <sup>4)</sup>		48.2 <sup>5)</sup>		45.4 <sup>6)</sup>		42.0 <sup>7)</sup>	23.9	23.9	23.9	23.9	23.9	33.9 <sup>11)</sup>	
355	B											48.9 <sup>3)</sup>		47.2 <sup>4)</sup>		46.8 <sup>5)</sup>		44.2 <sup>6)</sup>		41.9 <sup>7)</sup>	23.9	23.9	23.9	23.9	23.9	33.1 <sup>11)</sup>	
360	B											47.3 <sup>3)</sup>		45.7 <sup>4)</sup>		45.4 <sup>5)</sup>		42.9 <sup>6)</sup>		41.7 <sup>7)</sup>	23.9	23.9	23.9	23.9	23.9	32.8 <sup>11)</sup>	
365	B													44.2 <sup>3)</sup>		42.9 <sup>4)</sup>		41.7 <sup>5)</sup>		39.7 <sup>6)</sup>	23.9	23.9	23.9	23.9	23.9	32.3 <sup>11)</sup>	
370	B													42.7 <sup>3)</sup>		41.5 <sup>4)</sup>		40.4 <sup>5)</sup>		38.6 <sup>6)</sup>	23.9	23.9	23.9	23.9	23.9	31.7 <sup>11)</sup>	
375	B													41.2 <sup>3)</sup>		40.2 <sup>4)</sup>		39.2 <sup>5)</sup>		37.5 <sup>6)</sup>	23.9	23.9	23.9	23.9	23.9	31.5 <sup>11)</sup>	
380	B													39.7 <sup>3)</sup>		38.8 <sup>4)</sup>		37.9 <sup>5)</sup>		36.3 <sup>6)</sup>	23.9	23.9	23.9	23.9	23.9	30.6 <sup>11)</sup>	
385	B															37.4 <sup>3)</sup>		35.6 <sup>4)</sup>		35.2 <sup>5)</sup>	23.9	23.9	23.9	23.9	23.9	30.2 <sup>11)</sup>	
390	B															36.0 <sup>3)</sup>		34.3 <sup>4)</sup>		34.1 <sup>5)</sup>	23.9	23.9	23.9	23.9	23.9	30.1 <sup>11)</sup>	
395	B															34.7 <sup>3)</sup>		33.1 <sup>4)</sup>		33.0 <sup>5)</sup>	23.9	23.9	23.9	23.9	23.9	30.0 <sup>11)</sup>	
400	B															33.3 <sup>3)</sup>		31.9 <sup>4)</sup>		31.9 <sup>5)</sup>	23.9	23.9	23.9	23.9	23.9	29.9 <sup>11)</sup>	
405	B																	30.7 <sup>3)</sup>		29.6 <sup>4)</sup>	23.9	23.9	23.9	23.9	23.9	29.9 <sup>11)</sup>	
410	B																	29.5 <sup>3)</sup>		28.5 <sup>4)</sup>	23.9	23.9	23.9	23.9	23.9	29.9 <sup>11)</sup>	
415	B																	28.3 <sup>3)</sup>		27.4 <sup>4)</sup>	23.9	23.9	23.9	23.9	23.9	27.9 <sup>11)</sup>	
420	B																	27.1 <sup>3)</sup>		26.3 <sup>4)</sup>	23.9	23.9	23.9	23.9	23.9	27.0 <sup>11)</sup>	
425	B																			25.2 <sup>3)</sup>	23.9	23.9	23.9	23.9	23.9	26.0 <sup>11)</sup>	
430	B																			24.1 <sup>3)</sup>	23.9	23.9	23.9	23.9	23.9	25.1 <sup>11)</sup>	
435	B																			23.0 <sup>3)</sup>	23.9	23.9	23.9	23.9	23.9	24.2 <sup>11)</sup>	
440	B																				21.3 <sup>3)</sup>	23.9	23.9	23.9	23.9	23.9	23.2 <sup>11)</sup>
445	B																				20.1 <sup>3)</sup>	23.9	23.9	23.9	23.9	23.9	22.3 <sup>11)</sup>
450	B																				18.9 <sup>3)</sup>	23.9	23.9	23.9	23.9	23.9	21.4 <sup>11)</sup>
455	B																				17.9 <sup>3)</sup>	23.9	23.9	23.9	23.9	23.9	17.8 <sup>11)</sup>
460	B																				16.6 <sup>3)</sup>	23.9	23.9	23.9	23.9	23.9	15.9 <sup>11)</sup>
465	B																					15.9 <sup>3)</sup>	23.9	23.9	23.9	23.9	13.9 <sup>11)</sup>
470	B																					15.9 <sup>3)</sup>	23.9	23.9	23.9	23.9	12.0 <sup>11)</sup>
475	B																					15.9 <sup>3)</sup>	23.9	23.9	23.9	23.9	10.1 <sup>11)</sup>
	B																					15.9 <sup>3)</sup>	23.9	23.9	23.9	23.9	8.2 <sup>11)</sup>
	B																					15.9 <sup>3)</sup>	23.9	23.9	23.9	23.9	6.3 <sup>11)</sup>

1) 12°; 2) 17°; 3) 22°; 4) 27°; 5) 32°; 6) 37°; 7) 42°; 8) 47°; 9) 52°; 10) 57°; 11) 62°

# Lifting heights Hauteurs de levage

SDWB

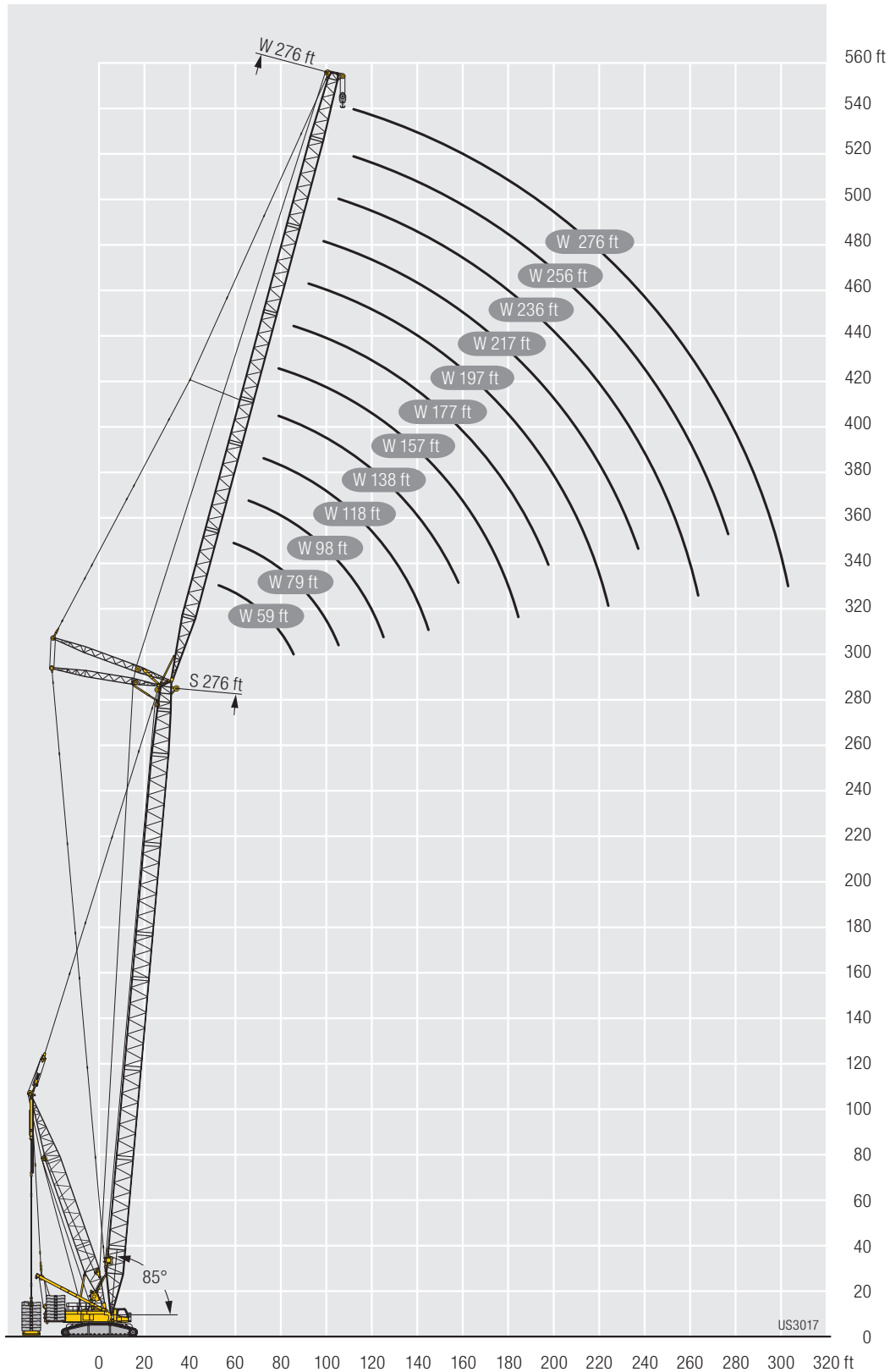

# Example Exemple

**Wmax**

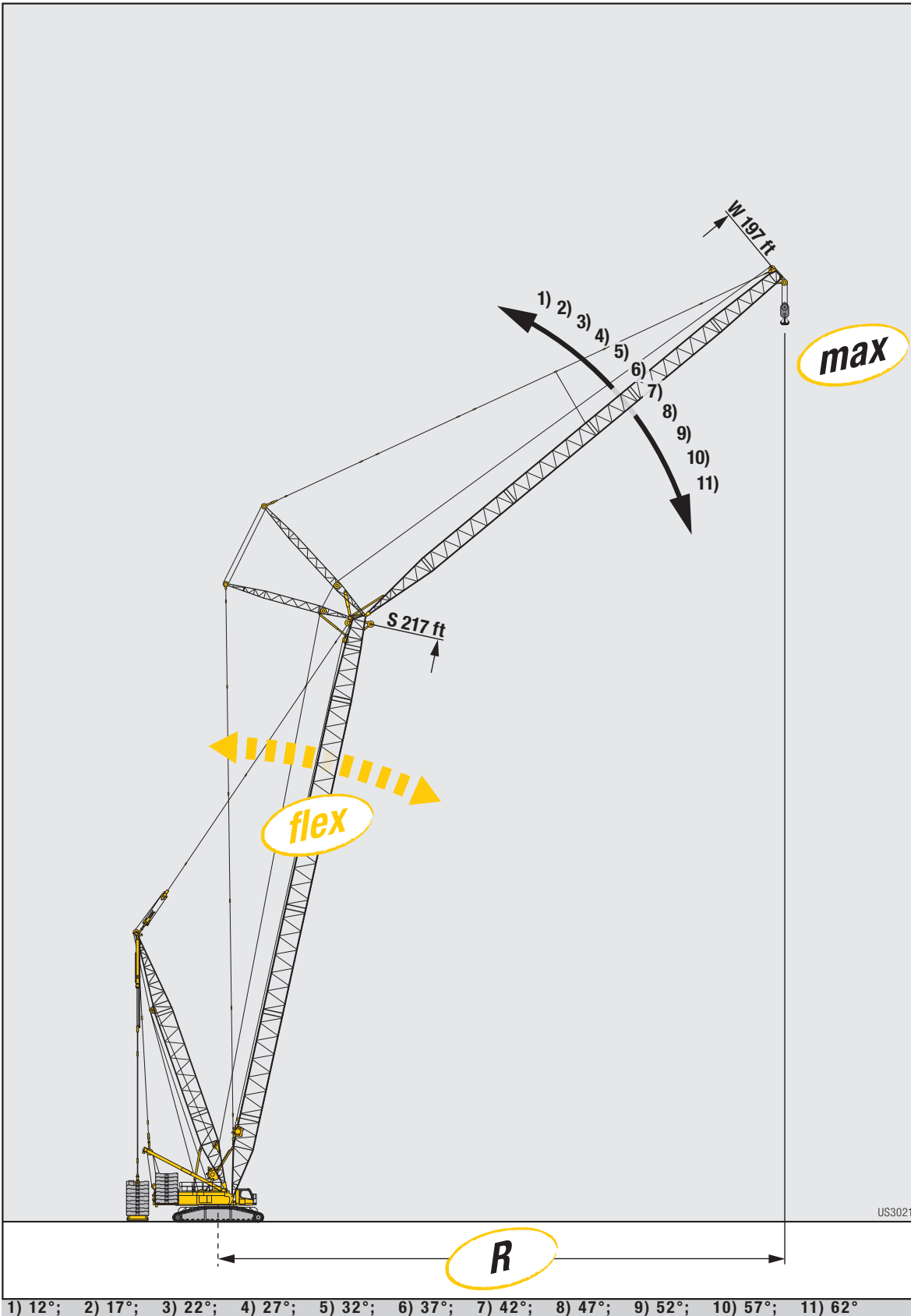

ft	ft	S 217	
		W 197	87°/85 Wmax
70	-	145.0°	145.0°
70	B	154.0°	154.0°
75	-	136.0°	136.0°
75	B	152.0°	152.0°
80	-	127.0°	127.0°
80	B	150.0°	152.0°
85	-	119.0°	119.0°
85	B	152.0°	152.0°
90	-	112.0°	112.0°
90	B	150.0°	150.0°
95	-	106.0°	106.0°
95	B	148.0°	149.0°
100	-	100.0°	100.0°
100	B	146.0°	149.0°
105	-	94.7°	94.7°
105	B	144.0°	148.0°
110	-	89.7°	89.7°
110	B	142.0°	147.0°
115	-	85.1°	85.1°
115	B	139.0°	146.0°
120	-	80.9°	80.9°
120	B	137.0°	145.0°
125	-	77.0°	77.0°
125	B	135.0°	144.0°
130	-	73.4°	73.4°
130	B	132.0°	143.0°
135	-	70.0°	70.0°
135	B	130.0°	142.0°
140	-	66.8°	66.8°
140	B	128.0°	141.0°
145	-	63.8°	63.8°
145	B	125.0°	140.0°
150	-	61.0°	61.0°
150	B	123.0°	139.0°
155	-	58.4°	58.4°
155	B	120.0°	139.0°
160	-	55.9°	55.9°
160	B	118.0°	138.0°
165	-	53.4°	53.4°
165	B	115.0°	137.0°
170	-	50.8°	50.8°
170	B	113.0°	136.0°
175	-	48.4°	48.4°
175	B	110.0°	135.0°
180	-	46.1°	46.1°
180	B	108.0°	134.0°
185	-	44.0°	44.0°
185	B	107.0°	133.0°
190	-	42.0°	42.0°
190	B	105.0°	132.0°
195	-	40.0°	40.0°
195	B	102.0°	131.0°
200	-	38.3°	38.3°
200	B	99.7°	130.0°
205	-	36.6°	36.6°
205	B	97.2°	130.0°
210	-	35.0°	35.0°
210	B	94.8°	129.0°
215	-	33.5°	33.5°
215	B	92.0°	128.0°
220	-	29.1	29.1
220	B	87.2°	127.0°
225	-	-	24.0 <sup>(1)</sup>
225	B	-	126.0°
230	-	-	21.4 <sup>(1)</sup>
230	B	-	125.0°
235	-	-	18.9 <sup>(1)</sup>
235	B	-	124.0°
240	-	-	16.8 <sup>(1)</sup>
240	B	-	123.0°
245	-	-	14.7 <sup>(1)</sup>
245	B	-	122.0°
250	-	-	12.6 <sup>(1)</sup>
250	B	-	120.0°
255	-	-	10.5 <sup>(1)</sup>
255	B	-	116.0°
260	-	-	114.0°
260	B	-	114.0°
265	-	-	111.0°
265	B	-	111.0°
270	-	-	109.0°
270	B	-	109.0°
275	-	-	106.0°
275	B	-	106.0°
280	-	-	104.0°
280	B	-	104.0°
285	-	-	101.0°
285	B	-	101.0°
290	-	-	99.5°
290	B	-	99.5°
295	-	-	97.5 <sup>(1)</sup>
295	B	-	97.5 <sup>(1)</sup>
300	-	-	94.4°
300	B	-	94.4°
305	-	-	91.4°
305	B	-	91.4°
310	-	-	88.4°
310	B	-	88.4°
315	-	-	85.5°
315	B	-	85.5°

US3021

1) 12°; 2) 17°; 3) 22°; 4) 27°; 5) 32°; 6) 37°; 7) 42°; 8) 47°; 9) 52°; 10) 57°; 11) 62°



# Lifting capacities Forces de levage

SLF



22,050 lbs/88,200 lbs



11,0250 - 374,800 lbs

ft	SL 118												SL 138																				
	F 39			F 59			F 79			F 98			F 118		F 39			F 59			F 79			F 98			F 118						
	10°	15°	30°	10°	15°	30°	10°	15°	30°	10°	15°	30°	15°	30°	10°	15°	30°	10°	15°	30°	10°	15°	30°	10°	15°	30°	10°	15°	30°	15°	30°		
32	271.0														217.0																		
34	271.0	270.0													271.0																		
36	271.0	265.0													271.0	270.0																	
38	271.0	260.0		233.0											271.0	264.0																	
40	271.0	253.0		227.0											271.0	258.0		229.0															
45	271.0	238.0	152.0	211.0	183.0		175.0								271.0	244.0	153.0	214.0	186.0														
50	266.0	224.0	146.0	198.0	173.0		163.0	144.0		147.0					271.0	231.0	148.0	202.0	176.0		158.0												
55	254.0	212.0	140.0	185.0	164.0	113.0	153.0	136.0		137.0					263.0	220.0	143.0	191.0	167.0		155.0	138.0		139.0									
60	239.0	201.0	135.0	174.0	155.0	109.0	145.0	129.0		128.0	114.0		106.0		250.0	209.0	138.0	181.0	159.0	110.0	149.0	131.0		131.0	115.0								
65	226.0	191.0	131.0	165.0	148.0	105.0	136.0	123.0	91.8	121.0	109.0		100.0		230.0	200.0	134.0	172.0	152.0	106.0	141.0	125.0		124.0	111.0				101.0				
70	213.0	183.0	127.0	156.0	141.0	101.0	129.0	117.0	88.4	115.0	104.0		94.5		211.0	191.0	130.0	163.0	146.0	103.0	134.0	119.0	89.3	117.0	105.0				95.7				
75	195.0	175.0	123.0	149.0	135.0	97.9	123.0	112.0	85.3	109.0	98.8	78.6	89.8		192.0	183.0	126.0	156.0	140.0	100.0	128.0	114.0	86.3	112.0	101.0				91.2				
80	179.0	167.0	119.0	141.0	129.0	94.8	117.0	107.0	82.3	103.0	94.2	76.0	85.4		176.0	175.0	123.0	149.0	134.0	97.1	122.0	110.0	83.6	106.0	96.3	76.2			87.2				
85	165.0	161.0	116.0	135.0	124.0	92.1	111.0	102.0	79.5	98.1	89.8	73.1	81.4	65.7	162.0	163.0	120.0	142.0	129.0	94.3	117.0	105.0	80.9	101.0	92.4	73.8			83.3	66.2			
90	152.0	152.0	113.0	129.0	119.0	89.5	106.0	97.7	76.9	93.4	86.0	70.6	77.8	63.3	150.0	150.0	117.0	136.0	125.0	91.8	112.0	101.0	78.5	97.0	88.5	71.4			79.8	63.9			
95	142.0	142.0	110.0	124.0	115.0	87.1	102.0	93.7	74.6	89.2	82.4	68.2	74.5	61.1	139.0	140.0	114.0	131.0	120.0	89.4	107.0	97.6	76.3	92.8	85.2	69.2			76.5	61.7			
100	132.0	132.0	108.0	119.0	111.0	84.7	97.3	90.3	72.5	85.3	79.1	66.1	71.3	58.9	129.0	130.0	112.0	126.0	116.0	87.3	103.0	94.1	74.3	88.9	81.9	67.2			73.5	59.7			
105	123.0	124.0	106.0	114.0	107.0	82.6	93.3	87.1	70.4	81.7	76.0	64.0	68.3	56.9	121.0	121.0	110.0	121.0	112.0	85.3	99.1	90.8	72.4	85.2	78.9	65.4			70.5	57.8			
110	115.0	116.0	104.0	110.0	104.0	80.6	89.8	84.0	68.4	78.4	73.2	62.0	65.5	55.0	113.0	113.0	108.0	114.0	109.0	83.5	95.5	87.8	70.5	82.0	76.1	63.6			67.8	56.0			
115	108.0	109.0	102.0	107.0	101.0	78.9	86.5	81.1	66.5	75.3	70.7	60.3	63.0	53.3	106.0	106.0	105.0	107.0	106.0	81.8	92.2	85.1	68.7	79.0	73.5	61.8			65.4	54.3			
120	102.0	103.0	100.0	103.0	97.5	77.3	83.4	78.4	64.9	72.4	68.3	58.6	60.6	51.7	99.5	100.0	102.0	101.0	102.0	80.1	89.0	82.5	67.2	76.1	71.2	60.1			63.1	52.8			
125	96.4	96.7	98.2	97.8	94.6	75.8	80.6	76.0	63.4	69.8	66.0	57.0	58.4	50.1	93.8	94.2	96.2	95.3	96.3	78.6	86.0	80.0	65.7	73.4	68.9	58.7			61.0	51.3			
130	91.0	91.4	92.8	92.4	92.3	74.3	78.0	73.7	61.9	67.4	63.8	55.5	56.4	48.5	88.5	88.8	90.7	90.0	90.9	77.1	83.3	77.6	64.2	71.0	66.7	57.2			59.0	49.8			
135	86.2	86.4	87.7	87.5	88.3	73.2	75.4	71.7	60.7	65.1	61.8	54.1	54.4	47.2	83.6	84.0	85.7	85.1	86.0	75.8	80.8	75.6	62.8	68.6	64.6	55.7			57.1	48.5			
140			83.0	83.0	83.7	72.1	73.1	69.6	59.5	63.0	59.9	52.8	52.6	45.9	79.1	79.5	81.1	80.6	81.4	74.5	78.5	73.6	61.5	66.5	62.7	54.4			55.2	47.2			
145				78.8	79.5	71.3	71.0	67.9	58.4	60.9	58.2	51.5	51.0	44.6	75.0	75.3	76.8	76.4	77.2	73.4	76.2	71.7	60.3	64.5	61.0	53.1			53.5	46.0			
150				75.0	75.5	70.6	68.9	66.1	57.3	59.0	56.5	50.4	49.5	43.5	71.2	71.4	72.8	72.5	73.3	72.3	73.5	69.8	59.4	62.6	59.4	52.0			51.8	44.9			
155					71.9	70.0	67.0	64.5	56.5	57.3	54.9	49.3	48.0	42.4			69.0	69.0	69.6	70.7	70.2	68.1	58.4	60.7	57.8	51.0			50.4	43.8			
160							65.2	63.0	55.6	55.6	53.5	48.2	46.7	41.4						67.7	66.8	66.5	57.5	58.8	56.3	50.0			49.0	42.7			
165							63.7	61.5	54.7	54.0	52.1	47.2	45.2	40.4						64.3	63.7	64.2	56.6	57.3	54.8	49.0			47.6	41.7			
170							62.2	60.2	54.0	52.5	50.8	46.4	44.0	39.4						61.3	60.7	61.2	55.7	55.9	53.5	48.1			46.3	40.8			
175									53.6	51.1	49.6	45.5	42.7	38.6						58.3	57.9	58.4	55.0	54.4	52.2	47.2			45.0	40.0			
180										49.9	48.4	44.8	41.5	37.7								55.3	55.7	54.4	53.1	51.0	46.4			43.7	39.2		
185										48.7	47.4	44.1	40.4	37.0								52.9	53.2	53.7	51.8	49.9	45.7			42.7	38.4		
190										47.6	46.4	43.5	39.4	36.3									50.9	51.9	50.5	48.8	45.0			41.7	37.6		
195											45.5	43.1	38.4	35.6											49.0	47.8	44.4			40.7	36.9		
200													37.6	34.9											46.9	46.9	43.9			39.8	36.2		
205													36.8	34.3											45.0	45.6	43.4			38.9	35.6		
210													36.0	33.8												43.7	42.9			38.0	35.0		
215														33.4																37.2	34.5		
220																														36.5	34.1		
225																														35.8	33.7		
230																															33.3		











# Lifting capacities Forces de levage

**SLF**



22,050 lbs/88,200 lbs



11,0250 - 374,800 lbs

ft	SL 315											SL 335			
	F 39			F 59			F 79			F 98			F 39		
	10°	15°	30°	10°	15°	30°	10°	15°	30°	10°	15°	30°	10°	15°	30°
55	155,0	146,0											140,0		
60	152,0	143,0		124,0									137,0	130,0	
65	149,0	141,0	120,0	121,0	112,0		103,0						134,0	127,0	112,0
70	146,0	139,0	118,0	118,0	110,0		100,0			88,2			131,0	125,0	110,0
75	143,0	136,0	117,0	116,0	107,0	90,6	98,1	90,0		86,1			129,0	123,0	108,0
80	135,0	133,0	115,0	114,0	105,0	89,1	95,9	88,1		84,1	77,2		125,0	120,0	107,0
85	125,0	126,0	113,0	112,0	103,0	87,5	93,8	86,3		82,2	75,6		119,0	117,0	105,0
90	116,0	118,0	112,0	110,0	101,0	86,1	91,8	84,6	71,4	80,3	74,0		112,0	113,0	104,0
95	108,0	110,0	110,0	107,0	99,5	84,7	90,1	82,9	70,2	78,5	72,5		104,0	106,0	102,0
100	101,0	103,0	106,0	102,0	97,7	83,4	88,3	81,4	69,0	76,9	71,0	59,2	97,0	98,6	100,0
105	94,5	95,8	99,5	95,2	95,1	82,2	86,5	79,9	67,8	75,3	69,6	58,2	90,5	92,0	96,6
110	88,4	89,6	93,1	89,2	90,9	80,9	84,9	78,4	66,7	73,7	68,3	57,2	84,6	85,9	90,4
115	82,8	84,0	87,2	83,7	85,3	79,7	82,7	77,1	65,7	72,2	67,0	56,3	79,1	80,3	84,7
120	77,6	78,8	81,8	78,5	80,1	78,6	79,5	75,7	64,7	70,8	65,7	55,4	74,0	75,2	79,3
125	72,7	73,9	76,7	73,7	75,2	77,6	74,7	74,4	63,7	69,5	64,6	54,6	69,2	70,4	74,4
130	68,3	69,2	71,9	69,2	70,7	74,8	70,4	71,7	62,8	68,0	63,4	53,8	64,8	66,0	69,7
135	63,7	64,6	67,0	65,1	66,4	70,6	66,2	68,0	62,0	65,5	62,4	53,0	60,8	61,8	65,4
140	59,5	60,2	62,5	60,9	62,1	66,0	62,3	63,9	61,2	62,3	61,3	52,2	56,8	57,8	61,0
145	55,4	56,3	58,3	56,8	58,0	61,7	58,3	59,9	60,4	58,7	60,4	51,5	52,9	53,8	56,8
150	51,6	52,4	54,5	53,1	54,2	57,7	54,6	56,0	59,7	55,1	57,5	50,8	49,3	50,2	53,0
155	48,2	49,0	50,9	49,6	50,7	54,0	51,0	52,4	56,7	51,6	54,1	50,1	45,7	46,6	49,4
160	44,8	45,6	47,5	46,2	47,4	50,6	47,8	49,1	53,2	48,3	50,7	49,4	42,6	43,3	46,1
165	41,9	42,6	44,4	43,2	44,1	47,4	44,8	46,0	49,9	45,2	47,6	48,8	39,5	40,3	42,8
170	38,9	39,7	41,3	40,3	41,3	44,4	41,7	43,1	46,8	42,4	44,6	47,7	36,7	37,3	40,0
175	36,4	36,9	38,6	37,6	38,5	41,4	39,1	40,2	43,9	39,7	41,9	45,4	34,0	34,7	37,1
180	33,8	34,4	35,9	35,1	35,9	38,8	36,5	37,7	41,2	37,0	39,4	42,7	31,4	32,1	34,5
185	31,4	32,0	33,5	32,6	33,5	36,2	34,1	35,2	38,6	34,7	36,8	40,1	29,1	29,7	32,1
190	29,2	29,8	31,1	30,4	31,2	33,9	31,8	32,8	36,2	32,4	34,5	37,7	26,8	27,5	29,7
195	27,1	27,5	28,9	28,2	29,0	31,5	29,6	30,7	33,9	30,2	32,3	35,4	24,8	25,3	27,5
200	25,1	25,6	26,8	26,2	26,9	29,4	27,6	28,5	31,6	28,2	30,2	33,1	22,8	23,4	25,4
205	23,2	23,6	24,8	24,3	25,0	27,4	25,7	26,6	29,6	26,2	28,2	31,1	21,1	21,5	23,5
210	21,6	22,0	22,9	22,6	23,1	25,4	23,9	24,7	27,6	24,5	26,3	29,1	19,6	20,0	21,6
215	20,0	20,4	21,4	21,0	21,6	23,6	22,2	23,0	25,7	22,7	24,6	27,1	18,1	18,5	20,1
220	18,7	19,0	19,9	19,6	20,0	21,9	20,7	21,5	23,9	21,2	22,9	25,4	16,7	17,1	18,6
225	17,3	17,7	18,5	18,2	18,7	20,5	19,3	20,0	22,3	19,9	21,3	23,6	15,4	15,8	17,3
230	16,1	16,4	17,2	16,9	17,4	19,1	18,0	18,7	20,9	18,5	20,0	22,1	14,2	14,5	16,0
235	14,9	15,2	15,9	15,7	16,2	17,8	16,8	17,4	19,5	17,4	18,7	20,7	13,0	13,3	14,7
240	13,7	14,0	14,7	14,6	15,0	16,6	15,6	16,2	18,3	16,2	17,6	19,4	11,9	12,2	13,5
245	12,7	12,9	13,6	13,5	13,9	15,4	14,5	15,1	17,0	15,0	16,4	18,2	10,7	11,1	12,3
250	11,6	11,9	12,5	12,4	12,8	14,3	13,4	14,0	15,9	14,0	15,3	17,0	9,6	9,9	11,2
255	10,6	10,8	11,4	11,4	11,7	13,2	12,4	12,9	14,7	12,9	14,2	15,9	8,4	8,7	10,2
260	9,6	9,8	10,4	10,4	10,7	12,1	11,4	11,9	13,7	12,0	13,2	14,8	7,2	7,6	9,1
265	8,4	8,7	9,4	9,5	9,8	11,1	10,5	10,9	12,6	11,0	12,2	13,8	6,1	6,4	8,0
270	7,3	7,5	8,2	8,5	8,9	10,1	9,6	10,0	11,7	10,1	11,3	12,7			6,8
275	6,2	6,5	7,1	7,4	7,8	9,2	8,6	9,1	10,7	9,2	10,4	11,8			5,7
280			6,0	6,4	6,7	8,1	7,7	8,2	9,8	8,3	9,5	10,8			
285					5,7	7,1	6,7	7,2	8,9	7,3	8,6	10,0			
290						6,0	5,7	6,2	7,9	6,4	7,8	9,1			
295									7,0		6,9	8,2			
300									5,9		5,9	7,4			
305												6,5			
310												5,5			

# Lifting heights Hauteurs de levage

SLF

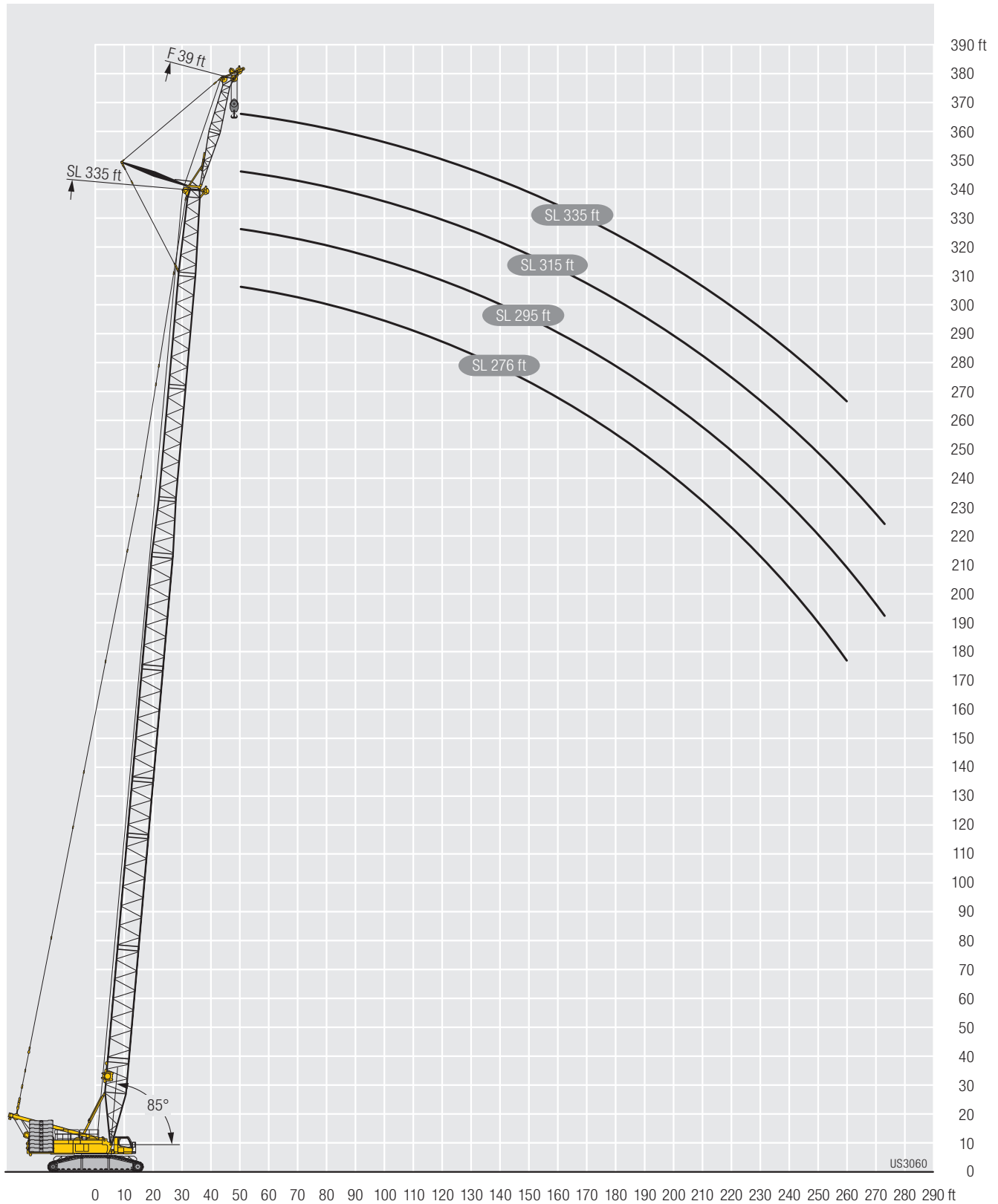

# Lifting heights Hauteurs de levage

SLF

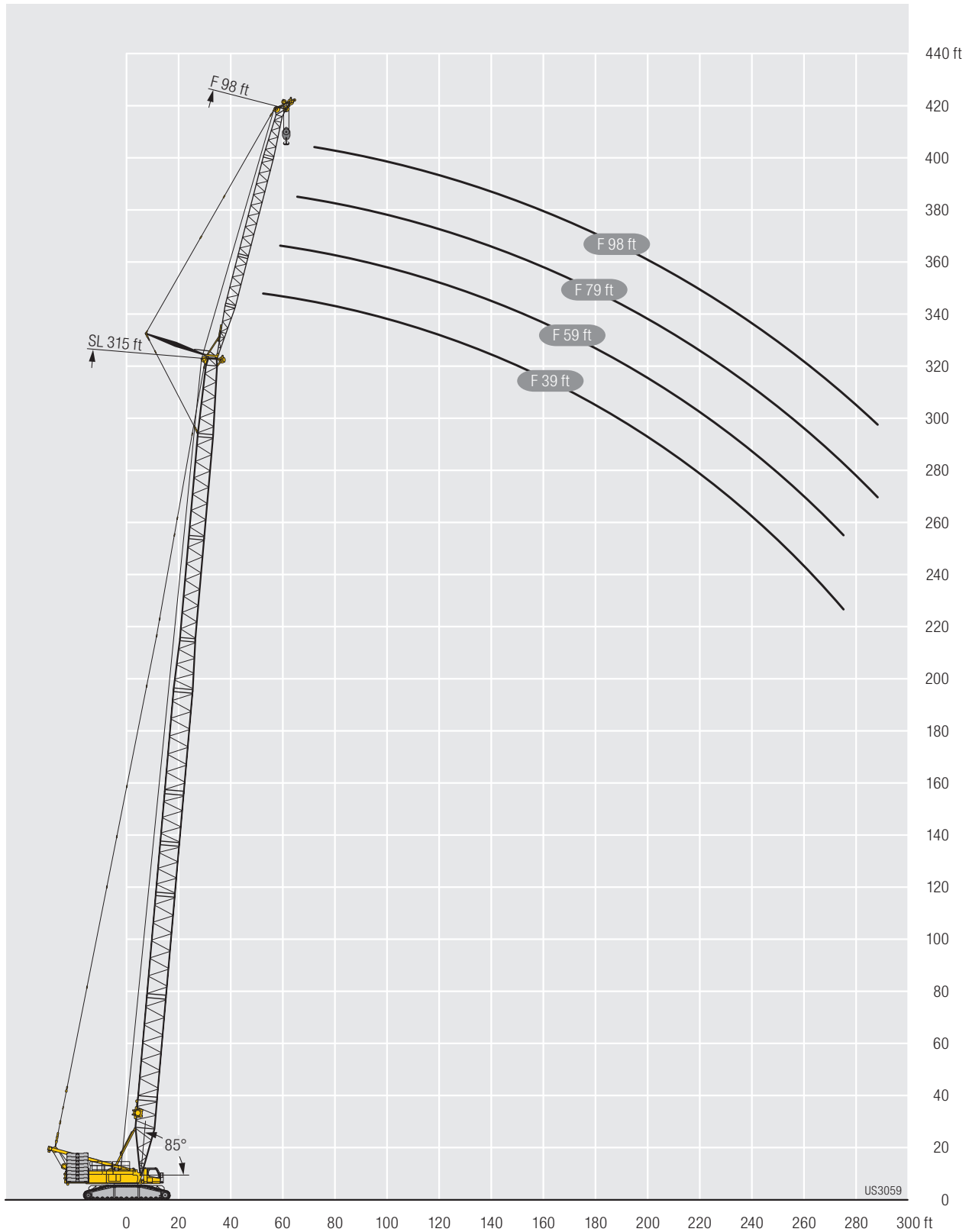





# Lifting capacities Forces de levage

## SL3F



22,050 lbs/88,200 lbs



11,0250 – 374,800 lbs

ft	SL 246												SL 256																																																																	
	F 39			F 59			F 79			F 98			F 118			F 39			F 59			F 79			F 98			F 118																																																		
	10°	15°	30°	10°	15°	30°	10°	15°	30°	10°	15°	30°	10°	15°	30°	10°	15°	30°	10°	15°	30°	10°	15°	30°	10°	15°	30°	10°	15°	30°	10°	15°	30°																																													
45	258.0															248.0																																																														
50	253.0	251.0		122.0												245.0			244.0																																																											
55	230.0	233.0	151.0	211.0												227.0			229.0			205.0																																																								
60	210.0	212.0	148.0	206.0			172.0			158.0						206.0			208.0			148.0			201.0			172.0			158.0																																															
65	192.0	194.0	144.0	192.0			167.0			158.0						189.0			191.0			145.0			188.0			167.0			158.0			140.0																																												
70	177.0	179.0	142.0	177.0			162.0			109.0			156.0			134.0			139.0						174.0			176.0			142.0			174.0			162.0			109.0			157.0			134.0			137.0																													
75	163.0	165.0	139.0	163.0			157.0			106.0			153.0			130.0			134.0			115.0			106.0			160.0			162.0			139.0			161.0			158.0			106.0			153.0			130.0			134.0			115.0																							
80	151.0	153.0	136.0	152.0			152.0			104.0			149.0			127.0			86.9			130.0			112.0			102.0			149.0			150.0			137.0			149.0			152.0			104.0			148.0			126.0			86.8			129.0			112.0			102.0														
85	141.0	142.0	134.0	141.0			144.0			102.0			141.0			123.0			85.0			125.0			109.0			98.8			138.0			140.0			134.0			139.0			141.0			102.0			139.0			123.0			85.0			125.0			109.0			98.6														
90	131.0	132.0	131.0	132.0			134.0			100.0			132.0			120.0			83.3			121.0			106.0			74.9			95.9			129.0			130.0			131.0			129.0			132.0			101.0			130.0			120.0			83.3			121.0			106.0			74.8			95.7								
95	122.0	124.0	128.0	123.0			126.0			98.6			124.0			116.0			81.7			118.0			103.0			73.1			93.0			120.0			121.0			127.0			121.0			123.0			98.8			122.0			117.0			81.7			118.0			103.0			73.1			92.8								
100	114.0	116.0	121.0	115.0			118.0			96.8			116.0			113.0			80.1			114.0			100.0			71.6			90.4			112.0			113.0			119.0			113.0			116.0			97.1			114.0			114.0			80.2			113.0			100.0			71.5			90.3			65.0					
105	107.0	108.0	113.0	108.0			111.0			95.2			109.0			110.0			78.7			108.0			97.4			70.2			87.7			105.0			106.0			111.0			106.0			109.0			95.5			107.0			109.0			78.8			106.0			97.4			70.1			87.9			63.5					
110	99.8	101.0	105.0	102.0			104.0			93.7			103.0			105.0			77.2			102.0			94.9			68.8			85.2			99.3			104.0			99.8			102.0			94.0			101.0			103.0			77.4			100.0			95.0			68.8			85.5			62.2								
115	93.0	93.8	98.0	94.9			96.8			92.2			96.7			98.5			75.8			96.3			92.4			67.4			82.9			60.7			91.5			92.5			96.8			93.5			95.6			92.5			95.1			96.9			76.0			94.5			92.7			67.5			83.3			60.8		
120	86.8	87.8	91.5	88.6			90.5			90.2			90.6			92.1			74.4			90.9			89.8			66.1			80.6			59.5			85.5			86.2			90.4			87.4			89.3			90.9			89.3			90.9			74.7			89.2			90.1			66.2			81.2			59.6		
125	81.2	81.8	85.7	82.9			84.7			88.6			84.8			86.3			73.1			85.2			86.8			64.8			78.5			58.2			79.7			80.7			84.5			81.7			83.5			87.4			83.6			85.1			73.3			84.0			86.5			65.0			79.1			58.4		
130	75.9	76.8	80.4	77.9			79.5			83.3			79.6			81.0			71.9			80.0			82.4			63.7			76.6			56.9			74.6			75.3			79.3			76.5			78.2			82.3			78.4			79.8			72.1			78.8			81.2			63.9			77.1			57.2		
135	71.2	71.8	75.4	72.9			74.7			78.3			74.8			76.0			70.7			75.2			77.5			62.5			74.7			55.8			69.7			70.6			74.2			71.7			73.4			77.2			73.6			74.9			71.0			73.9			76.3			62.8			75.3			56.1		
140	66.7	67.4	70.8	68.6			70.1			73.7			70.5			71.5			69.5			70.7			72.9			61.4			72.3			54.7			65.5			66.1			69.8			67.2			68.9			72.6			69.2			70.4			69.8			69.5			71.8			61.7			71.4			55.0		
145	62.7	63.3	66.6	64.3			65.9			69.4			66.2			67.5			68.4			66.7			68.7			60.3			68.5			53.7			61.3			62.0			65.4			63.2			64.7			68.4			65.1			66.3			68.5			65.4			67.6			60.6			67.4			53.9		
150	58.8	59.5	62.6	60.6			62.0			65.4			62.4			63.4			66.4			62.9			64.9			59.3			64.6			52.7			57.6			58.2			61.6			59.3			60.8			64.3			61.2			62.4			65.8			61.7			63.7			59.6			63.5			52.9		
155	55.3	55.9	59.0	57.0			58.4			61.6			58.7			59.9			63.2			59.3			61.3			58.2			61.0			51.8			54.0			54.6			57.9			55.8			57.3			60.7			57.7			58.7			62.1			58.1			60.2			58.6			59.9			52.0		
160	52.0	52.5	55.6	53.7			55.1			58.2			55.5			56.4			59.7			56.0			57.8			57.2			57.8			50.9			50.8			51.4			54.5			52.5			53.9			57.1			54.3			55.4			58.7			54.8			56.8			57.6			56.6			51.1		
165	48.9	49.5	52.3	50.6			51.9			54.9			52.3			53.4			56.4			52.8			54.7			56.1			54.6			50.0			47.7			48.2			51.3			49.4			50.8			53.9			51.2			52.2			55.3			51.7			53.6			56.4			53.5			50.2		
170	46.1	46.6	49.4	47.7			49.0			51.9			49.5			50.3			53.3			49.9			51.7			54.2			51.6			49.1			44.8			45.4			48.3			46.5			47.8			50.8			48.2			49.3			52.3			48.7			50.7			54.3			50.5			49.3		
175	43.4	43.8	46.5	45.0			46.1			48.9			46.6			47.6			50.4			47.1			49.0			52.3			48.9			48.2			42.2			42.6			45.5			43.7			45.1			48.0			45.6			46.4			49.4			46.0			47.8			51.4			47.8			48.4		
180	40.9	41.3	43.9	42.3			43.6			46.3			44.1			44.9			47.6			44.6			46.3			49.6			46.2			47.4			39.6			40.1			42.8			41.2			42.4			45.2			42.9			43.8			46.7			43.4			45.3			48.6			45.1			47.2		
185	38.5	38.9	41.4	40.0			41.1			43.7			41.6			42.5			45.1			42.1			43.8			46.9			43.8			46.6			37.3			37.7			40.3			38.7			40.0			42.7			40.5			41.3			44.0			41.0			42.7			46.1			42.7			45.7		
190	36.2	36.6	39.0	37.7			38.8			41.3			39.4			40.1			42.6			39.9			41.5			44.5			41.3			44.7			35.0			35.4			38.0			36.5			37.6			40.3			38.2			39.0			41.7			38.7			40.4			43.6			40.4			44.0		
195	34.1	34.5	36.8	35.5			36.6			39.0			37.2			37.9			40.3			37.6			39.3			42.2			39.2			42.6			32.9			33.3			35.7			34.3			35.5			38.0			36.1			36.8			39.3			36.6			38.1			41.3			38.1			41.8		
200	32.1	32.4	34.7	33.5			34.5			36.8			35.1			35.8			38.1			35.7			37.1			40.0			37.1			40.5			30.9			31.3			33.7			32.3			33.4			35.8			34.0			34.7			37.2			34.5			36.1			39.0			36.1			39.5		
205	30.2	30.5	32.7	31.5			32.6			34.8			33.2			33.8			36.1			33.7			35.2			37.9			35.2			38.4			29.0			29.3			31.7			30.4			31.4			33.7			32.0			32.7			35.1			32.6			34.1			37.0			34.0			37.5		
210	28.4	28.7	30.8	29.7			30.7			32.8			31.3			31.9			34.1			31.9			33.2			35.9			33.2			36.4			27.2			27.5			29.7			28.6			29.6			31.8			30.2			30.9			33.1			30.7			32.2			34.9			32.2			35.5		
215	26.7	27.0	29.0	28.0			28.9			30.9			29.6			30.1			32.2			30.1			31.5			34.0			31.5			34.5			25.5			25.8			28.0			26.8			27.8			30.0			28.4			29.1			31.2			29.0			30.4			33.1			30.4			33.6		
220	25.1	25.4	27.3	26.3			27.3			29.2			27.8			28.4			30.4			28.4			29.7			32.2			29.8			32.7			23.9			24.2			26.2			25.2			26.1			28.2			26.8			27.4			29.4			27.3			28.7			31.8								
225	23.6	23.8	25.6	24.8			25.6			27.5			26.3			26.8			28.7			26.8			28.1			30.5			28.1			31.0			22.4			22.7			24.6			23.6			24.5			26.5			25.2			25.7			27.7			25.7			27.1			29.6			27.1			30.1		
230	22.2	22.4	24.1	23.3			24.1			25.9			24.8			25.3			27.1																																																											





# Lifting capacities Forces de levage

**SL3F**



22,050 lbs/88,200 lbs



11,0250 - 374,800 lbs

ft	SL 285												SL 295																	
	F 39			F 59			F 79			F 98			F 118		F 39			F 59			F 79			F 98		F 118				
	10°	15°	30°	10°	15°	30°	10°	15°	30°	10°	15°	30°	15°	30°	10°	15°	30°	10°	15°	30°	10°	15°	30°	10°	15°	30°	10°	15°	30°	15°
50	223.0												211.0																	
55	215.0 216.0															207.0 206.0														
60	197.0	199.0	148.0	185.0									175.0																	
65	180.0	182.0	145.0	180.0	164.0	155.0						131.0																		
70	166.0	168.0	143.0	166.0	161.0	153.0			130.0																					
75	153.0	155.0	140.0	153.0	155.0	106.0	150.0 129.0			129.0																				
80	142.0	143.0	138.0	142.0	145.0	105.0	142.0	126.0	127.0 111.0			100.0	139.0 141.0 138.0 140.0 143.0 104.0 139.0 124.0 122.0 109.0 97.4																	
85	131.0	133.0	135.0	132.0	135.0	103.0	132.0	123.0	84.9	124.0 108.0		97.5	129.0 131.0 135.0 130.0 133.0 103.0 130.0 122.0 121.0 106.0 95.8																	
90	122.0	124.0	129.0	123.0	125.0	101.0	124.0	120.0	83.4	121.0 106.0		95.0	120.0 121.0 127.0 121.0 124.0 101.0 121.0 120.0 79.7 119.0 104.0 94.1																	
95	114.0	115.0	121.0	115.0	117.0	99.5	115.0	116.0	82.0	114.0 103.0 73.0		92.5	112.0 113.0 119.0 113.0 116.0 99.7 113.0 116.0 79.7 112.0 101.0 72.8 92.0																	
100	106.0	108.0	113.0	108.0	110.0	98.0	108.0	110.0	80.7	107.0 101.0 71.6		90.1	104.0 106.0 111.0 106.0 108.0 98.2 106.0 108.0 79.7 105.0 98.6 71.5 89.7																	
105	99.5	101.0	106.0	101.0	103.0	96.5	101.0	104.0	79.4	101.0 98.2 70.3		87.9	97.5 98.7 104.0 98.9 102.0 96.7 99.5 102.0 79.6 98.7 96.5 70.2 87.5 63.1																	
110	93.3	94.5	99.3	94.7	96.4	95.1	95.3	97.4	78.0	94.6 95.8 69.0		85.7	62.0		91.2 92.4 97.4 92.8 95.3 95.2 93.4 95.5 78.8 92.8 93.5 69.1 85.5 61.8															
115	87.5	88.6	93.2	89.0	90.5	93.4	89.7	91.6	76.7	89.1 92.0 67.8		83.6	60.9		85.5 86.7 91.4 87.1 89.6 93.0 87.8 89.8 77.7 87.2 89.6 68.0 83.5 60.7															
120	81.9	83.1	87.0	83.7	85.1	90.6	84.4	86.3	75.4	83.9 87.1 66.7		81.6	59.8		80.1 81.3 85.7 81.8 84.2 88.8 82.6 84.4 76.7 82.1 84.4 66.8 81.4 59.5															
125	76.4	77.3	81.1	78.5	79.8	84.6	79.5	81.3	74.3	79.1 82.2 65.6		79.4	58.7		75.0 76.0 79.9 76.8 79.1 83.5 77.8 79.6 75.7 77.4 79.6 65.6 79.0 58.4															
130	71.4	72.1	75.8	73.4	74.6	79.2	74.8	76.4	73.1	74.7 77.7 64.5		76.5	57.6		69.8 70.8 74.5 72.0 74.1 78.1 73.2 74.9 74.6 73.0 75.1 64.5 74.9 57.4															
135	66.6	67.5	70.9	68.6	69.8	74.1	70.0	71.5	71.8	70.3 73.1 63.4		72.4	56.5		65.3 66.1 69.6 67.3 69.2 73.0 68.8 70.4 73.2 68.8 70.8 63.5 70.6 56.4															
140	62.2	62.9	66.4	64.2	65.3	69.5	65.6	67.0	70.0	66.0 68.6 62.3		68.2	55.5		60.8 61.8 65.1 62.9 64.7 68.4 64.3 65.8 71.0 64.7 66.5 62.5 66.6 55.5															
145	58.2	59.0	62.2	60.2	61.2	65.2	61.5	62.9	67.1	61.9 64.4 61.3		64.2	54.6		56.9 57.6 61.0 58.9 60.6 64.1 60.2 61.6 66.7 60.7 62.4 61.6 62.9 54.6															
150	54.4	55.0	58.3	56.3	57.4	61.2	57.7	59.0	63.0	58.1 60.5 60.4		60.3	53.6		53.0 53.9 57.0 55.1 56.9 60.1 56.4 57.8 62.7 56.9 58.6 60.6 59.2 53.7															
155	50.9	51.6	54.6	52.9	53.8	57.6	54.2	55.4	59.2	54.5 56.9 59.4		56.7	52.8		49.6 50.2 53.5 51.5 53.2 56.4 53.0 54.2 58.9 53.3 54.9 59.6 55.6 52.8															
160	47.6	48.2	51.2	49.4	50.5	54.1	50.8	52.1	55.7	51.4 53.5 57.9		53.4	51.9		46.3 47.0 50.0 48.3 49.9 53.0 49.7 50.9 55.4 50.0 51.5 56.9 52.2 52.0															
165	44.6	45.2	48.0	46.4	47.2	50.8	47.8	48.8	52.4	48.2 50.4 54.6		50.2	51.0		43.3 43.8 46.9 45.1 46.8 49.7 46.5 47.7 52.1 47.1 48.4 53.6 49.1 51.2															
170	41.7	42.2	45.0	43.4	44.4	47.8	44.8	46.0	49.4	45.3 47.5 51.5		47.2	50.2		40.4 41.1 43.8 42.3 43.8 46.7 43.7 44.7 49.0 44.1 45.6 50.5 46.1 50.1															
175	39.0	39.6	42.2	40.8	41.5	44.9	42.1	43.1	46.4	42.6 44.6 48.6		44.6	48.8		37.7 38.3 41.1 39.5 41.1 43.8 40.8 42.0 46.2 41.4 42.8 47.6 43.4 48.1															
180	36.5	37.0	39.6	38.2	39.0	42.2	39.5	40.5	43.7	39.9 42.1 45.9		41.9	46.4		35.2 35.8 38.4 37.0 38.4 41.1 38.4 39.3 43.3 38.9 40.1 44.8 40.9 45.4															
185	34.1	34.6	37.1	35.8	36.5	39.6	37.1	38.0	41.1	37.6 39.5 43.3		39.5	43.8		32.8 33.3 36.0 34.6 36.1 38.6 35.9 36.9 40.8 36.4 37.7 42.3 38.3 42.8															
190	31.9	32.3	34.8	33.5	34.2	37.2	34.8	35.7	38.7	35.3 37.2 40.7		37.2	41.3		30.6 31.1 33.6 32.3 33.7 36.2 33.6 34.6 38.4 34.2 35.3 39.8 36.1 40.3															
195	29.7	30.2	32.5	31.4	32.0	34.9	32.6	33.5	36.4	33.2 35.0 38.5		34.9	39.1		28.5 28.9 31.4 30.2 31.5 33.9 31.5 32.4 36.1 31.9 33.2 37.5 33.9 38.0															
200	27.7	28.2	30.4	29.3	30.0	32.8	30.6	31.4	34.2	31.1 32.9 36.2		32.9	36.8		26.5 27.0 29.3 28.2 29.4 31.7 29.4 30.3 33.9 29.9 31.0 35.3 31.7 35.8															
205	25.8	26.3	28.4	27.4	28.0	30.7	28.6	29.5	32.2	29.1 30.9 34.2		30.9	34.7		24.6 25.0 27.3 26.2 27.5 29.7 27.5 28.3 31.8 28.0 29.1 33.1 29.8 33.7															
210	24.0	24.4	26.5	25.6	26.2	28.8	26.8	27.6	30.1	27.3 29.0 32.2		29.0	32.7		22.8 23.2 25.4 24.4 25.6 27.7 25.6 26.4 29.8 26.2 27.2 31.2 27.9 31.8															
215	22.3	22.7	24.7	23.9	24.4	26.9	25.0	25.8	28.3	25.5 27.3 30.3		27.2	30.8		21.3 21.6 23.6 22.7 23.9 25.9 23.9 24.6 27.9 24.4 25.4 29.3 26.1 29.8															
220	21.0	21.3	23.0	22.2	22.8	25.2	23.4	24.1	26.5	23.9 25.5 28.5		25.5	29.0		19.9 20.2 22.0 21.2 22.2 24.2 22.2 23.0 26.1 22.7 23.7 27.5 24.4 28.1															
225	19.6	19.9	21.6	20.9	21.3	23.5	21.8	22.6	24.8	22.3 23.9 26.7		23.9	27.3		18.6 18.9 20.6 19.8 20.8 22.5 20.9 21.5 24.4 21.4 22.1 25.8 22.8 26.3															
230	18.4	18.7	20.2	19.6	20.0	22.0	20.6	21.1	23.2	21.0 22.4 25.1		22.4	25.6		17.3 17.6 19.3 18.6 19.5 21.1 19.6 20.2 22.9 20.0 20.8 24.1 21.5 24.7															
235	17.2	17.4	18.9	18.4	18.8	20.7	19.3	19.9	21.8	19.8 21.1 23.5		21.1	24.0		16.2 16.4 18.0 17.4 18.3 19.8 18.4 18.9 21.4 18.8 19.5 22.6 20.1 23.2															
240	16.1	16.3	17.7	17.2	17.6	19.4	18.2	18.6	20.4	18.6 19.8 22.1		19.9	22.6		15.0 15.3 16.8 16.2 17.1 18.5 17.2 17.7 20.1 17.6 18.4 21.2 19.0 21.7															
245	15.0	15.2	16.6	16.1	16.5	18.2	17.0	17.5	19.2	17.5 18.7 20.8		18.7	21.3		13.9 14.2 15.6 15.1 16.0 17.3 16.1 16.6 18.9 16.5 17.2 20.0 17.8 20.5															
250	13.8	14.1	15.5	15.1	15.4	17.1	16.0	16.4	18.1	16.4 17.6 19.6		17.6	20.1		12.7 13.0 14.5 14.1 14.9 16.2 15.0 15.5 17.7 15.5 16.1 18.8 16.7 19.3															
255	12.6	12.9	14.4	14.0	14.4	16.0	14.9	15.4	16.9	15.4 16.5 18.5		16.6	19.0		11.4 11.7 13.4 13.0 13.8 15.1 14.0 14.4 16.6 14.4 15.1 17.7 15.7 18.1															
260	11.5	11.7	13.2	13.0	13.3	14.9	14.0	14.4	15.9	14.4 15.5 17.4		15.6	17.9		10.3 10.5 12.2 11.9 12.8 14.1 13.0 13.4 15.5 13.5 14.0 16.6 14.6 17.1															
265	10.4	10.6	12.0	11.9	12.2	13.9	13.0	13.4	14.8	13.5 14.5 16.4		14.6	16.8		9.2 9.4 11.0 10.8 11.7 13.0 12.0 12.4 14.5 12.5 13.1 15.6 13.7 16.0															
270	9.3	9.5	10.9	10.8	11.1	12.9	12.1	12.5	13.9	12.6 13.6 15.4		13.7	15.8		8.1 8.4 9.9 9.6 10.6 12.0 11.0 11.4 13.5 11.6 12.1 14.5 12.7 15.0															
275		8.5	9.7	9.7	10.1	11.8	11.0	11.5	12.9	11.7 12.7 14.4		12.8	14.9		7.0 7.3 8.7 8.6 9.4 10.8 9.9 10.4 12.5 10.7 11.3 13.6 11.9 14.0															
280				8.7	9.0	10.7	9.9	10.4	12.0	10.8 11.8 13.5		11.9	13.9		6.1 6.3 7.6 7.6 8.4 9.7 8.9 9.4 11.6 9.7 10.3 12.6 11.0 13.1															
285				7.7	8.0	9.6	9.0	9.4	11.0	9.8 11.0 12.6		11.1	13.0		6.6 6.6 7.4 8.6 7.8 8.3 10.6 8.7 9.3 11.8 10.1 12.2															
290				6.8	7.0	8.5	8.0	8.4	9.9	8.9 10.0 11.7		10.2	12.2		5.7 6.5 7.6 6.8 7.3 9.5 7.8 8.4 10.9 9.3 11.4															
295				6.1	7.5	7.1	7.5	8.9	7.8	9.1 10.8		9.4	11.3		6.6 5.9 6.3 8.4 6.8 7.4 10.0 8.4 10.5															
300						6.2	6.5	7.9	7.0	8.0 9.9		8.5	10.5		5.6 7.4 5.9 6.5 9.0 7.4 9.7															
305							5.7	6.9	6.2	7.2 8.9		7.6	9.7		6.5 5.6 8.1 6.5 8.9															
310								6.0		6.3 7.9		6.7	8.9		5.5 7.1 5.7 7.9															
315										7.0		5.8	7.9		6.1 7.0															
320										6.1			7.0		6.1															
325										6.1			6.1																	



# Lifting capacities Forces de levage

**SL3F**



22,050 lbs/88,200 lbs



11,0250 - 374,800 lbs

ft	SL 325						SL 335		
	F 39			F 59			F 39		
	10°	15°	30°	10°	15°	30°	10°	15°	30°
55	185.0						173.0		
60	180.0	176.0		155.0			169.0	165.0	
65	169.0	170.0	145.0	153.0	142.0		165.0	162.0	
70	155.0	157.0	143.0	150.0	140.0		152.0	154.0	140.0
75	143.0	145.0	140.0	144.0	139.0		140.0	142.0	139.0
80	132.0	134.0	137.0	133.0	135.0	104.0	129.0	132.0	136.0
85	122.0	124.0	130.0	124.0	126.0	102.0	120.0	122.0	128.0
90	114.0	115.0	121.0	115.0	118.0	101.0	111.0	113.0	119.0
95	106.0	107.0	112.0	108.0	110.0	99.6	104.0	105.0	110.0
100	98.7	100.0	105.0	100.0	102.0	98.2	96.4	98.0	103.0
105	92.0	93.5	98.1	93.9	95.7	96.6	89.9	91.4	96.0
110	85.9	87.3	91.7	87.9	89.6	94.8	84.0	85.3	89.8
115	80.4	81.7	85.8	82.3	84.0	89.3	78.5	79.7	84.1
120	75.3	76.4	80.5	77.1	78.8	84.0	73.3	74.6	78.7
125	70.5	71.6	75.5	72.4	73.9	78.9	68.5	69.8	73.8
130	66.0	67.1	70.7	68.0	69.4	74.2	64.2	65.3	69.1
135	61.8	62.7	66.1	63.8	65.2	69.7	60.1	61.1	64.7
140	57.5	58.5	61.5	59.8	61.1	65.1	56.1	57.0	60.3
145	53.7	54.4	57.3	55.7	57.0	60.8	52.2	53.1	56.1
150	49.8	50.8	53.4	52.0	53.1	56.8	48.6	49.4	52.2
155	46.4	47.1	50.0	48.6	49.5	53.1	44.9	45.9	48.6
160	43.1	43.9	46.5	45.3	46.3	49.6	41.8	42.5	45.4
165	40.0	40.8	43.4	42.1	43.2	46.4	38.8	39.6	42.1
170	37.2	37.9	40.4	39.3	40.2	43.5	35.9	36.6	39.2
175	34.5	35.2	37.6	36.5	37.5	40.6	33.3	34.0	36.4
180	32.0	32.6	35.0	34.0	34.8	37.9	30.7	31.4	33.8
185	29.6	30.3	32.4	31.6	32.5	35.3	28.4	29.0	31.3
190	27.4	28.0	30.2	29.3	30.1	32.9	26.1	26.8	29.0
195	25.3	25.9	27.9	27.2	28.0	30.7	24.1	24.6	26.8
200	23.4	23.8	25.8	25.1	25.9	28.4	22.2	22.8	24.7
205	21.6	22.1	23.8	23.3	24.0	26.5	20.5	20.9	22.8
210	20.0	20.4	22.1	21.5	22.3	24.5	19.0	19.4	21.0
215	18.6	19.0	20.5	20.1	20.6	22.8	17.5	17.9	19.5
220	17.2	17.5	19.0	18.7	19.2	21.2	16.1	16.5	18.0
225	15.9	16.2	17.6	17.3	17.8	19.7	14.8	15.2	16.7
230	14.6	14.9	16.3	16.0	16.5	18.3	13.6	13.9	15.4
235	13.4	13.8	15.1	14.8	15.3	17.0	12.4	12.7	14.1
240	12.2	12.6	13.9	13.7	14.1	15.8	11.1	11.5	12.9
245	11.0	11.4	12.7	12.5	13.0	14.6	9.8	10.2	11.7
250	9.7	10.1	11.5	11.5	11.9	13.5	8.5	8.9	10.5
255	8.4	8.8	10.3	10.4	10.8	12.4	7.2	7.6	9.3
260	7.2	7.6	9.1	9.2	9.7	11.3	6.1	6.4	7.9
265	6.1	6.5	7.8	8.0	8.5	10.2			6.7
270			6.7	6.8	7.3	9.0			
275			5.6	5.7	6.2	7.8			
280						6.7			
285						5.6			

# Lifting heights Hauteurs de levage

SL3F

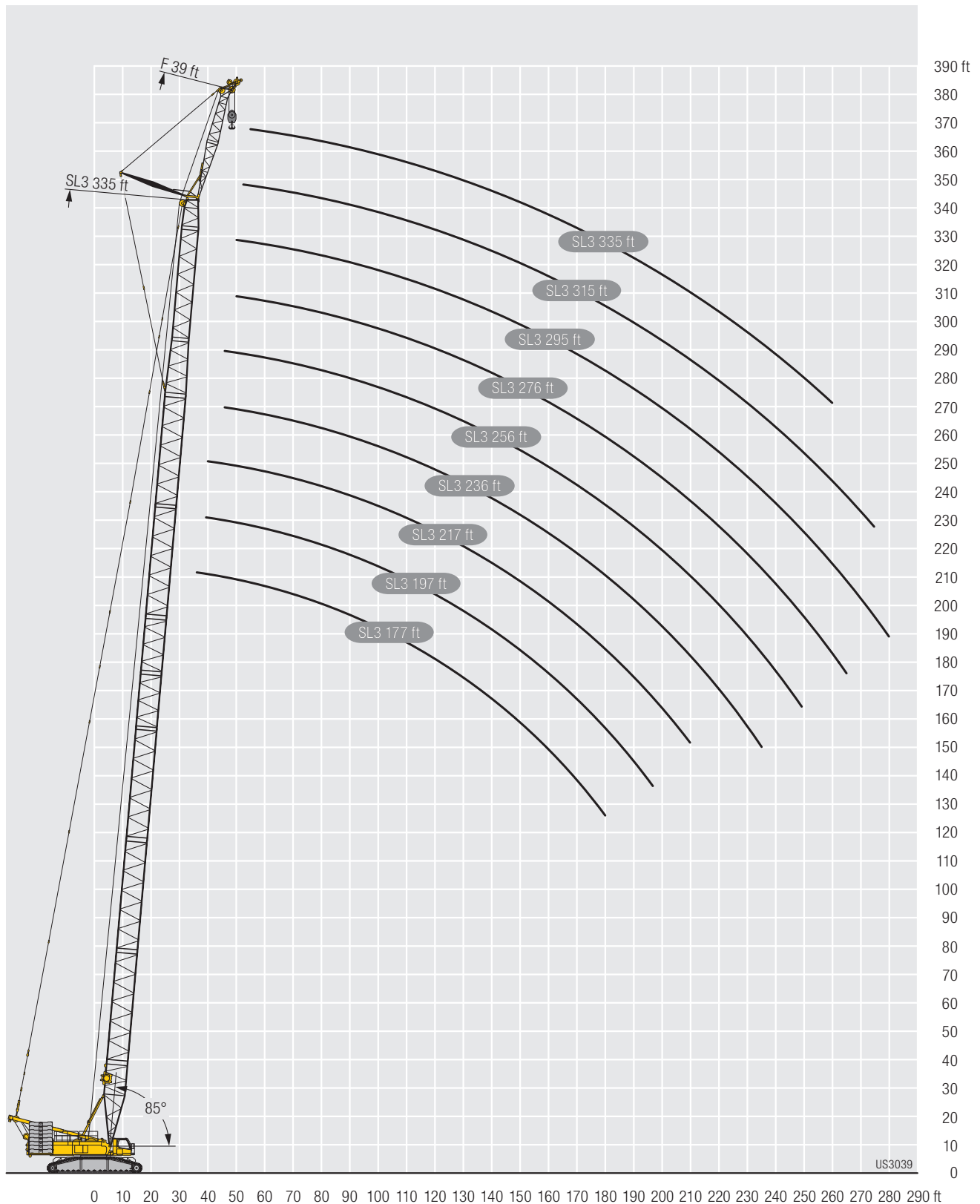

# Lifting heights Hauteurs de levage

SL3F

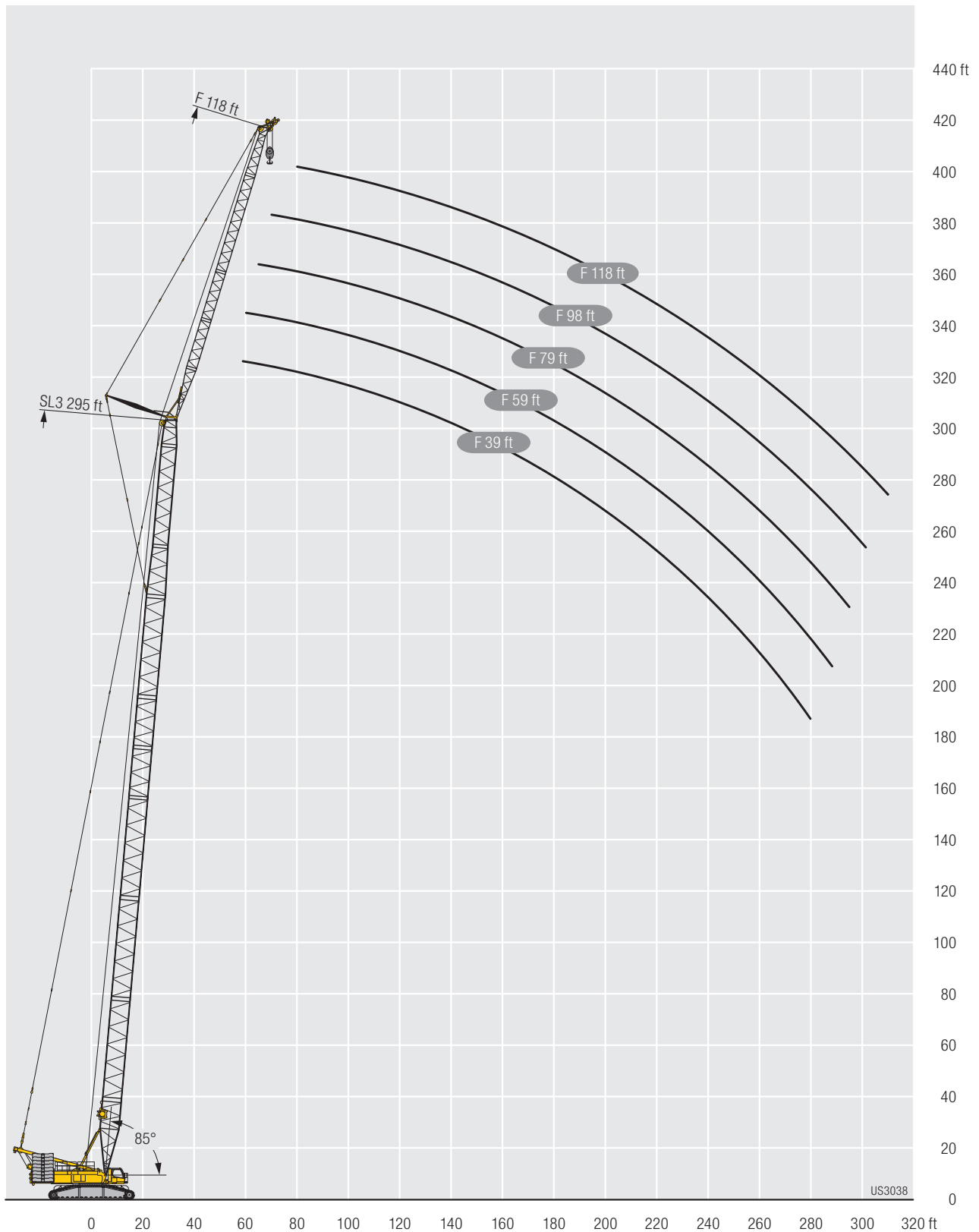

US3038

# Lifting capacities Forces de levage

**SL4DFB**



286,600 lbs - 374,800 lbs  
529,100 lbs - 617,300 lbs  
330,700 lbs - 463,000 lbs  
66,100 lbs - 264,600 lbs

		SL4 177 - 433																												
ft	B	177 ft		197 ft		217 ft		236 ft		256 ft		276 ft		295 ft		315 ft		335 ft		354 ft		374 ft		394 ft		413 ft		433 ft		
		10°	15°	10°	15°	10°	15°	10°	15°	10°	15°	10°	15°	10°	15°	10°	15°	10°	15°	10°	15°	10°	15°	10°	15°	10°	15°	10°	15°	
38	-	271.0																												
	B	271.0																												
40	-	271.0		271.0																										
	B	271.0		271.0																										
45	-	271.0	258.0	271.0	260.0	271.0	261.0	268.0		258.0																				
	B	271.0	258.0	271.0	260.0	271.0	262.0	270.0		258.0																				
50	-	271.0	247.0	267.0	249.0	271.0	252.0	250.0	251.0	259.0	252.0	246.0		231.0		215.0														
	B	271.0	247.0	271.0	249.0	271.0	252.0	271.0	253.0	259.0	253.0	246.0		231.0		215.0														
55	-	251.0	236.0	271.0	240.0	268.0	242.0	261.0	229.0	256.0	245.0	244.0	241.0	231.0	230.0	216.0	213.0	199.0		182.0										
	B	271.0	236.0	271.0	240.0	271.0	243.0	271.0	244.0	261.0	245.0	247.0	241.0	232.0	230.0	216.0	213.0	199.0		182.0										
60	-	228.0	226.0	258.0	230.0	250.0	234.0	242.0	236.0	234.0	235.0	227.0	226.0	225.0	222.0	213.0	211.0	199.0	196.0	182.0	179.0	178.0	158.0	162.0		146.0				
	B	271.0	226.0	271.0	234.0	271.0	234.0	271.0	236.0	262.0	237.0	248.0	237.0	233.0	231.0	216.0	213.0	199.0	196.0	182.0	179.0	178.0	158.0	162.0		146.0				
65	-	209.0	211.0	237.0	222.0	234.0	225.0	227.0	224.0	220.0	221.0	213.0	210.0	207.0	209.0	200.0	198.0	189.0	192.0	182.0	179.0	177.0	158.0	162.0	157.0	146.0	141.0	131.0	127.0	
	B	262.0	217.0	269.0	222.0	271.0	226.0	270.0	229.0	262.0	230.0	248.0	231.0	233.0	229.0	216.0	213.0	199.0	195.0	182.0	179.0	178.0	158.0	162.0	157.0	146.0	141.0	131.0	127.0	
70	-	192.0	194.0	223.0	214.0	216.0	216.0	209.0	211.0	202.0	204.0	196.0	198.0	191.0	193.0	185.0	187.0	178.0	182.0	174.0	175.0	167.0	158.0	159.0	156.0	145.0	141.0	130.0	126.0	
	B	252.0	209.0	259.0	214.0	266.0	219.0	267.0	221.0	263.0	224.0	249.0	225.0	233.0	225.0	216.0	212.0	199.0	195.0	182.0	178.0	178.0	158.0	162.0	156.0	145.0	141.0	130.0	126.0	
75	-	178.0	179.0	207.0	206.0	200.0	202.0	194.0	195.0	187.0	189.0	182.0	184.0	177.0	179.0	171.0	173.0	165.0	168.0	161.0	163.0	154.0	155.0	149.0	152.0	142.0	139.0	118.0	119.0	
	B	241.0	201.0	249.0	207.0	256.0	212.0	261.0	215.0	262.0	217.0	250.0	219.0	233.0	221.0	216.0	211.0	199.0	194.0	182.0	177.0	178.0	158.0	162.0	156.0	145.0	140.0	129.0	126.0	
80	-	165.0	166.0	192.0	193.0	186.0	188.0	180.0	182.0	174.0	176.0	169.0	171.0	164.0	166.0	159.0	161.0	153.0	156.0	149.0	151.0	143.0	146.0	138.0	141.0	134.0	134.0	124.0	123.0	
	B	231.0	194.0	240.0	200.0	247.0	205.0	252.0	209.0	256.0	211.0	249.0	213.0	234.0	216.0	217.0	209.0	199.0	193.0	182.0	176.0	178.0	158.0	161.0	155.0	143.0	139.0	128.0	125.0	
85	-	152.0	153.0	179.0	180.0	173.0	175.0	168.0	169.0	162.0	164.0	157.0	159.0	153.0	154.0	148.0	150.0	142.0	145.0	139.0	141.0	132.0	135.0	128.0	131.0	124.0	126.0	118.0	119.0	
	B	222.0	187.0	231.0	193.0	238.0	199.0	244.0	203.0	248.0	206.0	246.0	208.0	234.0	211.0	217.0	208.0	199.0	191.0	181.0	175.0	177.0	158.0	160.0	154.0	142.0	139.0	127.0	124.0	
90	-	140.0	141.0	167.0	168.0	162.0	163.0	157.0	158.0	151.0	153.0	147.0	148.0	142.0	144.0	138.0	140.0	133.0	135.0	129.0	131.0	123.0	126.0	119.0	122.0	115.0	117.0	111.0	112.0	
	B	213.0	181.0	222.0	187.0	230.0	193.0	236.0	197.0	241.0	200.0	242.0	203.0	234.0	206.0	216.0	206.0	198.0	190.0	181.0	174.0	176.0	158.0	158.0	153.0	141.0	137.0	126.0	123.0	
95	-	130.0	131.0	155.0	156.0	152.0	153.0	147.0	148.0	142.0	143.0	138.0	139.0	133.0	135.0	129.0	130.0	124.0	126.0	121.0	122.0	115.0	118.0	111.0	113.0	107.0	109.0	103.0	105.0	
	B	205.0	175.0	214.0	181.0	223.0	187.0	229.0	192.0	234.0	195.0	237.0	198.0	233.0	202.0	215.0	202.0	197.0	188.0	180.0	172.0	175.0	158.0	157.0	152.0	140.0	136.0	125.0	122.0	
100	-	121.0	121.0	144.0	145.0	142.0	143.0	139.0	139.0	133.0	134.0	129.0	130.0	125.0	126.0	121.0	122.0	116.0	118.0	113.0	114.0	107.0	110.0	103.0	106.0	99.6	101.0	95.2	97.0	
	B	198.0	170.0	207.0	176.0	215.0	182.0	222.0	187.0	227.0	191.0	231.0	193.0	231.0	197.0	214.0	198.0	196.0	187.0	179.0	171.0	174.0	158.0	156.0	151.0	139.0	135.0	124.0	121.0	
105	-	112.0	113.0	135.0	135.0	132.0	133.0	129.0	130.0	125.0	126.0	121.0	122.0	117.0	119.0	113.0	114.0	108.0	111.0	105.0	107.0	99.9	102.0	96.0	98.9	92.8	94.4	88.3	90.1	
	B	191.0	165.0	200.0	171.0	209.0	177.0	215.0	182.0	220.0	186.0	225.0	189.0	227.0	193.0	212.0	195.0	195.0	185.0	178.0	170.0	173.0	158.0	155.0	150.0	137.0	133.0	122.0	120.0	
110	-	105.0	106.0	126.0	127.0	123.0	124.0	121.0	122.0	117.0	119.0	114.0	115.0	110.0	111.0	106.0	107.0	102.0	104.0	98.8	100.0	93.4	96.0	89.7	92.3	86.3	88.0	82.1	83.6	
	B	185.0	160.0	194.0	167.0	202.0	173.0	209.0	177.0	214.0	182.0	219.0	185.0	223.0	189.0	209.0	191.0	193.0	184.0	177.0	169.0	172.0	158.0	153.0	149.0	136.0	132.0	121.0	119.0	
115	-	98.2	98.9	118.0	119.0	116.0	116.0	113.0	114.0	110.0	111.0	107.0	108.0	104.0	105.0	99.9	101.0	95.5	97.7	92.8	94.0	87.3	89.9	83.8	86.4	80.5	82.0	76.2	77.8	
	B	179.0	156.0	188.0	162.0	196.0	168.0	203.0	173.0	208.0	177.0	213.0	181.0	219.0	185.0	207.0	187.0	191.0	181.0	175.0	167.0	171.0	158.0	152.0	148.0	135.0	130.0	120.0	117.0	
120	-	92.1	92.7	111.0	112.0	108.0	109.0	106.0	107.0	103.0	104.0	101.0	102.0	97.7	98.9	94.0	95.2	89.7	91.9	87.1	88.3	81.8	84.2	78.2	80.9	75.0	76.4	70.9	72.4	
	B	174.0	152.0	182.0	158.0	191.0	164.0	197.0	169.0	203.0	173.0	208.0	177.0	214.0	181.0	205.0	184.0	189.0	180.0	173.0	165.0	169.0	158.0	150.0	147.0	133.0	130.0	118.0	116.0	
125	-	86.5	87.1	104.0	105.0	102.0	103.0	99.4	100.0	96.5	97.5	94.4	95.3	92.1	93.0	88.5	89.7	84.3	86.5	81.8	83.1	76.6	78.9	73.2	75.6	69.8	71.2	65.9	67.3	
	B	169.0	148.0	177.0	154.0	185.0	160.0	192.0	165.0	198.0	169.0	203.0	173.0	208.0	178.0	201.0	180.0	187.0	178.0	172.0	164.0	1								

# Lifting capacities Forces de levage

## SL4DFB



286,600 lbs –  
374,800 lbs



529,100 lbs – 617,300 lbs  
330,700 lbs – 463,000 lbs  
66,100 lbs – 264,600 lbs

ft		SL4 177 – 433																											
		177 ft		197 ft		217 ft		236 ft		256 ft		276 ft		295 ft		315 ft		335 ft		354 ft		374 ft		394 ft		413 ft		433 ft	
		10°	15°	10°	15°	10°	15°	10°	15°	10°	15°	10°	15°	10°	15°	10°	15°	10°	15°	10°	15°	10°	15°	10°	15°	10°	15°	10°	15°
215	-					40.1	37.3	37.6	34.6	34.9	32.7	33.0	30.5	30.9	28.3	28.7	25.5	26.6	24.1	24.6	20.6	21.8	18.8	20.0	16.5	17.2	13.8	14.6	
	-			117.0	133.0	121.0	139.0	125.0	144.0	129.0	150.0	133.0	146.0	135.0	134.0	132.0	124.0	121.0	128.0	126.0	115.0	113.0	102.0	99.7	93.6	92.1			
220	-				35.5	35.7	32.7	33.0	30.8	31.1	28.6	29.0	26.4	26.9	23.7	24.8	22.4	22.9	19.0	20.2	17.1	18.4	14.8	15.4	11.9	12.7			
	-				131.0	120.0	137.0	123.0	142.0	127.0	147.0	132.0	144.0	133.0	132.0	129.0	122.0	120.0	125.0	124.0	114.0	112.0	100.0	98.5	92.4	90.8			
225	-				33.7	33.9	31.0	31.3	29.0	29.4	26.9	27.2	24.7	25.1	21.9	23.0	20.7	21.1	17.5	18.6	15.4	16.8	13.0	13.7	10.1	10.9			
	-				130.0	119.0	135.0	122.0	140.0	126.0	145.0	130.0	142.0	131.0	131.0	128.0	120.0	118.0	124.0	122.0	113.0	111.0	99.0	97.2	91.3	89.7			
230	-					32.2	29.3	29.6	27.4	27.7	25.2	25.5	23.0	23.4	20.5	21.5	19.3	19.7	16.1	17.2	13.7	15.3			12.0	8.4	9.2		
	-					117.0	133.0	121.0	138.0	124.0	143.0	129.0	140.0	130.0	129.0	127.0	118.0	116.0	122.0	120.0	111.0	109.0	97.3	96.0	90.3	88.8			
235	-						27.7	27.9	25.8	26.0	23.6	23.9	21.5	21.8	19.1	20.1	17.9	18.3	14.6	15.8	12.2	13.7			6.6	7.4			
	-						131.0	119.0	136.0	123.0	140.0	127.0	137.0	129.0	128.0	125.0	117.0	114.0	121.0	119.0	109.0	108.0	95.2	94.3	89.3	87.8			
240	-						26.2	26.4	24.2	24.5	22.1	22.3	20.2	20.5	17.9	18.7	16.6	17.0	13.2	14.4	10.6	12.2			9.3	9.2	87.8	86.8	
	-						129.0	118.0	134.0	121.0	137.0	126.0	135.0	127.0	126.0	124.0	115.0	113.0	119.0	118.0	107.0	106.0	93.7	92.6	87.8	86.8			
245	-						24.7	24.9	22.8	23.1	20.8	21.1	19.0	19.3	16.6	17.5	15.4	15.7	11.7	13.0		10.7			8.6	8.5			
	-						127.0	117.0	132.0	120.0	134.0	124.0	132.0	126.0	125.0	124.0	114.0	112.0	118.0	117.0	106.0	104.0	92.4	91.2	86.1	85.3			
250	-						21.6	21.7	19.6	19.8	17.8	18.1	15.5	16.3	14.2	14.5	10.3	11.7							8.1	8.3			
	-						130.0	119.0	130.0	123.0	128.0	124.0	123.0	123.0	113.0	111.0	116.0	115.0	105.0	103.0	91.1	89.9	85.1	83.8					
255	-						20.4	20.6	18.5	18.7	16.7	16.9	14.3	15.1	13.0	13.4	8.9	10.3							8.4	8.2			
	-						128.0	118.0	127.0	121.0	125.0	121.0	122.0	122.0	112.0	110.0	115.0	114.0	104.0	102.0	89.8	88.7	84.0	82.8					
260	-						19.3	19.5	17.4	17.6	15.6	15.8	13.2	14.0	12.0	12.3	7.6	8.9							8.2	8.1			
	-						124.0	116.0	122.0	119.0	121.0	119.0	119.0	119.0	111.0	109.0	112.0	113.0	103.0	101.0	88.5	87.5	82.8	81.7					
265	-						16.4	16.5	14.6	14.8	12.1	12.9	10.9	11.2	6.3	7.6									8.1	8.0			
	-						118.0	116.0	117.0	116.0	116.0	117.0	116.0	117.0	110.0	108.0	110.0	110.0	102.0	100.0	87.2	86.4	81.6	80.6					
270	-						15.4	15.5	13.6	13.7	11.1	11.9	9.8	10.1			6.4								8.0	7.9			
	-						114.0	114.0	113.0	114.0	112.0	113.0	108.0	107.0	107.0	107.0	107.0	107.0	100.0	99.2	86.0	85.3	80.4	79.5					
275	-						14.4	14.6	12.6	12.8	10.0	10.8	8.6	9.0											7.9	7.8			
	-						110.0	111.0	110.0	111.0	109.0	110.0	106.0	105.0	104.0	105.0	98.4	97.8	85.0	84.0	79.4	78.4	74.7	74.0					
280	-						11.5	11.7	8.8	9.6			107.0	108.0	106.0	107.0	104.0	103.0	102.0	102.0	96.6	96.2	84.0	82.8	78.6	77.5			
	-						10.3	10.6	7.7	8.5			104.0	105.0	103.0	103.0	101.0	101.0	99.1	99.6	94.8	94.6	83.3	82.0	77.7	76.7			
285	-						9.3	9.5	6.7	7.4			101.0	102.0	100.0	101.0	98.4	98.6	96.5	97.2	92.9	93.0	82.6	81.2	76.8	75.8			
	-						5.6	6.4					97.4	97.8	95.8	96.2	94.0	94.7	90.8	91.3	81.8	80.4	75.8	74.9					
290	-												94.7	95.1	93.3	93.8	91.5	92.4	88.3	88.9	81.1	79.6	74.7	74.0					
	-												92.1	92.4	90.9	91.4	88.9	89.9	85.8	86.5	80.3	78.8	73.7	73.1					
300	-												88.5	89.0	86.3	87.4	83.0	83.7	78.7	77.6	72.6	72.1							
	-												85.9	86.5	83.4	84.6	80.3	80.9	77.0	76.1	71.5	71.2							
305	-												83.0	83.6	80.4	81.5	77.7	78.3	75.1	74.5	70.2	70.2							
	-												77.4	78.5	75.1	75.6	73.0	72.7	68.8	68.9									
310	-												74.5	75.4	73.2	73.5	71.0	70.9	67.3	67.5									
	-												72.3	73.0	71.2	71.6	69.0	69.1	65.8	66.0									
315	-												69.3	69.7	67.0	67.3	64.2	64.5											
	-												67.4	67.7	65.3	65.6	62.6	62.9											
320	-												65.6	65.9	63.5	63.9	61.1	61.4											
	-												64.0	61.8	62.2	59.5	59.8												
325	-												60.1	60.5	58.0	58.3													
	-												58.4	58.9	56.4	56.7													
330	-												57.2	54.9	55.2														
	-												53.4	53.7															
335	-												51.9	52.2															
	-												50.6																



# Lifting heights Hauteurs de levage

**SL4DFB**

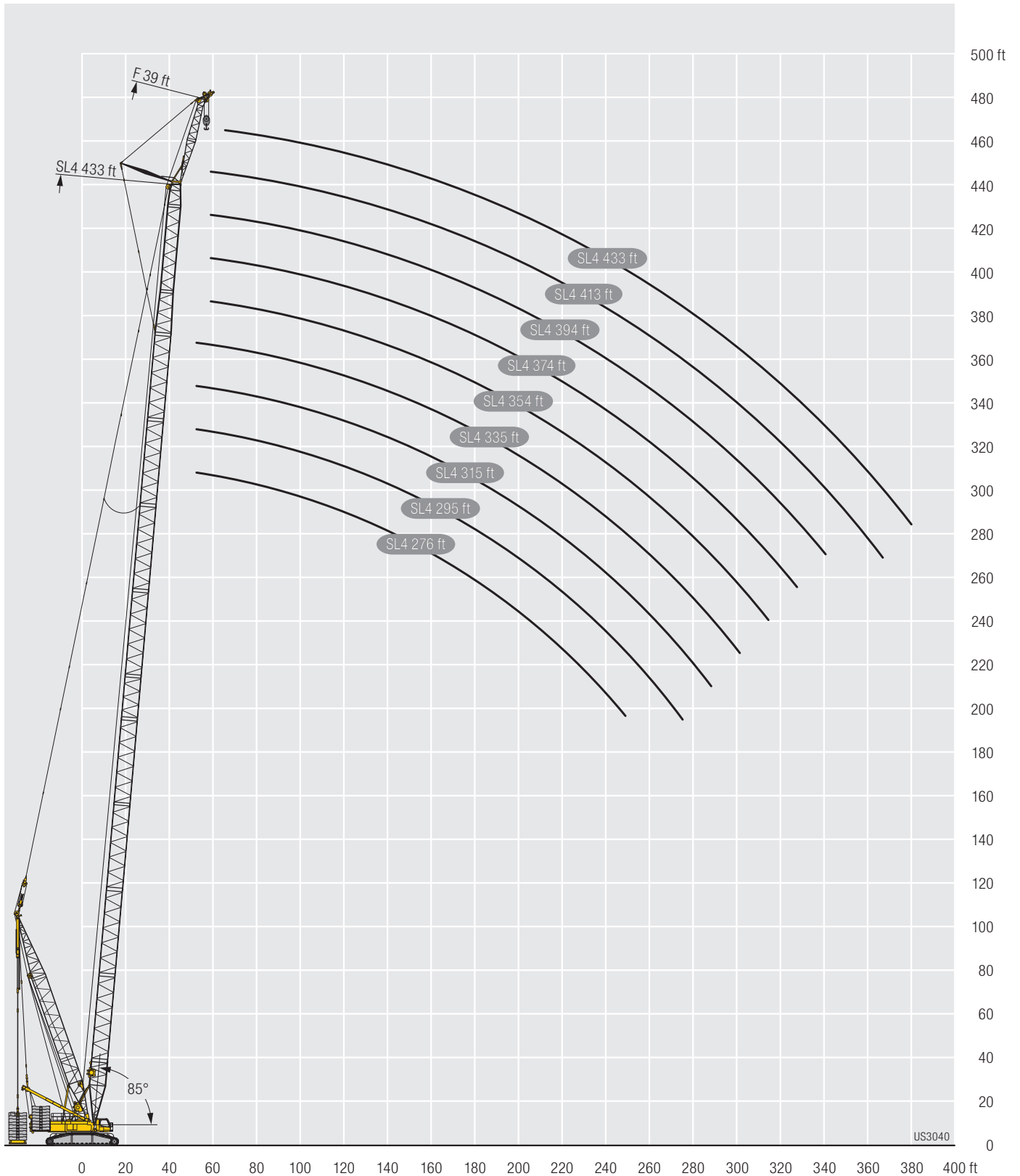

# Lifting capacities Forces de levage

**SL8F**

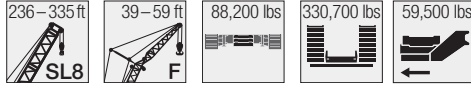

ft	SL 236				SL 246				SL 256				SL 266				SL 276				
	F 39		F 59		F 39		F 59		F 39		F 59		F 39		F 59		F 39		F 59		
	10°	15°	10°	15°	10°	15°	10°	15°	10°	15°	10°	15°	10°	15°	10°	15°	10°	15°	10°	15°	
55	253.0				248.0	242.0			244.0					239.0							
60	231.0	233.0			226.0	229.0	206.0		223.0	225.0				219.0	221.0			215.0	217.0		
65	211.0	214.0	198.0		207.0	210.0	199.0	167.0	204.0	206.0	198.0			200.0	203.0	198.0		197.0	199.0	195.0	
70	195.0	197.0	190.0	162.0	191.0	193.0	190.0	162.0	188.0	190.0	188.0	162.0		184.0	187.0	185.0	163.0	181.0	183.0	182.0	162.0
75	180.0	182.0	179.0	157.0	176.0	178.0	177.0	157.0	174.0	176.0	174.0	158.0		170.0	172.0	171.0	158.0	168.0	169.0	168.0	158.0
80	167.0	169.0	167.0	152.0	164.0	165.0	164.0	153.0	161.0	163.0	162.0	154.0		158.0	160.0	159.0	154.0	155.0	157.0	156.0	154.0
85	155.0	157.0	156.0	148.0	152.0	154.0	153.0	149.0	150.0	151.0	150.0	150.0		147.0	149.0	148.0	148.0	144.0	146.0	145.0	147.0
90	145.0	146.0	146.0	144.0	142.0	144.0	143.0	144.0	140.0	141.0	141.0	143.0		137.0	138.0	138.0	141.0	134.0	136.0	135.0	138.0
95	136.0	137.0	136.0	138.0	133.0	134.0	134.0	136.0	131.0	132.0	132.0	134.0		128.0	129.0	129.0	132.0	126.0	127.0	127.0	129.0
100	127.0	128.0	128.0	130.0	124.0	126.0	125.0	128.0	122.0	124.0	123.0	126.0		120.0	121.0	121.0	123.0	117.0	119.0	119.0	121.0
105	118.0	119.0	120.0	122.0	116.0	118.0	118.0	120.0	115.0	116.0	116.0	118.0		112.0	113.0	113.0	116.0	110.0	111.0	111.0	114.0
110	110.0	111.0	112.0	114.0	109.0	110.0	111.0	113.0	107.0	108.0	109.0	111.0		105.0	106.0	106.0	109.0	103.0	104.0	105.0	107.0
115	103.0	104.0	105.0	107.0	101.0	102.0	103.0	105.0	100.0	101.0	102.0	104.0		98.4	99.5	100.0	103.0	96.8	98.0	98.3	101.0
120	96.4	97.3	98.3	100.0	94.8	95.7	96.6	98.5	93.8	94.5	95.6	97.6		91.8	92.8	94.0	96.0	90.5	91.6	92.5	94.7
125	90.4	91.2	92.3	93.8	88.7	89.4	90.5	92.4	87.5	88.6	89.5	91.4		86.0	86.9	87.9	89.8	84.6	85.5	86.7	88.7
130	84.8	85.4	86.5	88.4	83.0	84.0	85.1	86.7	82.1	82.8	84.1	85.7		80.2	81.3	82.4	84.2	79.2	80.1	81.1	83.1
135	79.6	80.4	81.5	83.0	78.0	78.6	79.8	81.6	76.9	77.8	79.0	80.7		75.3	76.1	77.4	79.0	74.0	74.8	76.0	77.8
140	75.0	75.6	76.6	78.3	73.2	74.0	75.2	76.7	72.3	73.0	74.1	75.8		70.5	71.4	72.6	74.4	69.4	70.2	71.4	73.1
145	70.5	71.2	72.4	73.7	68.9	69.5	70.7	72.3	67.8	68.6	69.8	71.4		66.3	67.0	68.2	69.8	64.9	65.7	66.9	68.8
150	66.5	67.1	68.2	69.7	64.8	65.5	66.7	68.1	63.9	64.5	65.7	67.2		62.1	62.9	64.1	65.8	61.0	61.7	63.0	64.5
155	62.8	63.2	64.4	65.8	61.1	61.7	62.8	64.3	60.1	60.7	61.9	63.4		58.4	59.1	60.3	61.8	57.2	57.8	59.1	60.8
160	59.2	59.8	60.9	62.2	57.5	58.0	59.3	60.7	56.6	57.2	58.3	59.8		54.9	55.5	56.8	58.3	53.7	54.4	55.6	57.1
165	56.0	56.4	57.5	58.9	54.2	54.8	56.0	57.3	53.3	53.8	55.0	56.5		51.6	52.2	53.5	54.9	50.4	51.0	52.2	53.8
170	52.9	53.3	54.5	55.6	51.2	51.7	52.9	54.2	50.2	50.8	51.9	53.3		48.6	49.1	50.3	51.8	47.4	48.0	49.2	50.6
175	50.0	50.5	51.5	52.7	48.3	48.8	50.0	51.2	47.4	47.8	49.0	50.3		45.7	46.2	47.4	48.8	44.5	45.0	46.2	47.7
180	47.3	47.7	48.8	49.9	45.6	46.1	47.2	48.4	44.6	45.1	46.3	47.5		43.0	43.5	44.7	46.0	41.8	42.4	43.6	44.9
185	44.7	45.1	46.2	47.3	43.1	43.5	44.6	45.8	42.1	42.6	43.7	44.9		40.4	40.9	42.1	43.4	39.3	39.7	40.9	42.3
190	42.3	42.7	43.8	44.9	40.6	41.1	42.2	43.3	39.7	40.1	41.3	42.4		38.1	38.5	39.7	40.9	36.8	37.4	38.5	39.8
195	40.1	40.4	41.5	42.5	38.4	38.8	39.9	41.0	37.5	37.9	38.9	40.1		35.8	36.2	37.4	38.5	34.6	35.1	36.2	37.5
200	37.9	38.2	39.3	40.3	36.3	36.6	37.7	38.7	35.3	35.7	36.8	37.9		33.6	34.1	35.2	36.4	32.4	32.9	34.1	35.3
205	35.9	36.2	37.3	38.2	34.2	34.6	35.6	36.7	33.3	33.6	34.7	35.8		31.6	32.0	33.2	34.3	30.5	30.9	32.0	33.2
210	34.0	34.3	35.3	36.2	32.3	32.6	33.7	34.7	31.4	31.7	32.8	33.8		29.7	30.1	31.2	32.3	28.5	28.9	30.1	31.2
215	32.2	32.4	33.4	34.3	30.5	30.8	31.8	32.8	29.6	29.9	30.9	31.9		27.9	28.2	29.3	30.4	26.7	27.1	28.2	29.3
220	30.5	30.7	31.7	32.5	28.8	29.0	30.1	31.0	27.8	28.1	29.1	30.1		26.2	26.4	27.6	28.6	25.0	25.3	26.5	27.5
225	28.8	29.0	30.0	30.8	27.1	27.4	28.4	29.2	26.2	26.5	27.5	28.4		24.5	24.8	25.9	26.9	23.3	23.7	24.8	25.8
230	27.3	27.5	28.4	29.2	25.6	25.8	26.8	27.6	24.6	24.9	25.9	26.8		23.0	23.3	24.3	25.2	21.9	22.2	23.2	24.2
235	25.8	26.0	26.9	27.6	24.1	24.3	25.3	26.1	23.2	23.4	24.4	25.2		21.6	21.8	22.8	23.7	20.6	20.8	21.7	22.6
240			25.4	26.1	22.7	22.9	23.8	24.6	21.8	22.0	22.9	23.7		20.4	20.6	21.5	22.3	19.4	19.6	20.5	21.3
245			24.1	24.7			22.5	23.2	20.7	20.8	21.7	22.3		19.2	19.4	20.3	21.0	18.3	18.5	19.3	20.1
250			22.8	23.4			21.3	21.9	19.6	19.7	20.5	21.2		18.1	18.3	19.1	19.9	17.2	17.4	18.2	19.0
255				22.1			20.2	20.8			19.5	20.1		17.0	17.2	18.1	18.8	16.1	16.3	17.1	17.9
260							19.2	19.7			18.4	19.0			16.1	17.1	17.7	14.9	15.1	16.1	16.8
265											17.5	18.0				16.1	16.7	13.7	13.9	15.1	15.8
270												17.1				15.0	15.6			14.0	14.7
275																13.9	14.6			12.9	13.6
280																				11.8	12.5
285																				10.8	11.4

# Lifting capacities Forces de levage

**SL8F**

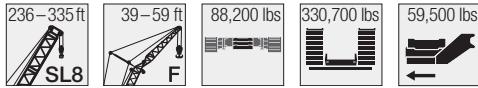

ft	SL 285				SL 295				SL 305				SL 315				SL 325				SL 335	
	F 39		F 59		F 39		F 59		F 39		F 59		F 39		F 59		F 39		F 59		F 39	
	10°	15°	10°	15°	10°	15°	10°	15°	10°	15°	10°	15°	10°	15°	10°	15°	10°	15°	10°	15°	10°	15°
55		228.0								211.0				203.0								
60	211.0	213.0	194.0		208.0	207.0	186.0		202.0	202.0			195.0	193.0			189.0	188.0			180.0	
65	193.0	195.0	189.0	166.0	191.0	193.0	182.0	162.0	187.0	189.0	177.0		184.0	184.0	168.0		179.0	179.0	163.0		174.0	171.0
70	178.0	180.0	178.0	162.0	176.0	178.0	176.0	159.0	172.0	175.0	171.0	155.0	170.0	172.0	165.0	149.0	167.0	169.0	159.0	146.0	163.0	164.0
75	164.0	166.0	165.0	158.0	162.0	164.0	163.0	155.0	159.0	161.0	160.0	152.0	157.0	159.0	157.0	147.0	154.0	157.0	153.0	144.0	152.0	154.0
80	152.0	154.0	153.0	154.0	150.0	152.0	151.0	151.0	147.0	149.0	148.0	147.0	145.0	147.0	146.0	142.0	142.0	145.0	143.0	140.0	141.0	143.0
85	141.0	143.0	142.0	145.0	140.0	141.0	141.0	143.0	137.0	138.0	138.0	140.0	135.0	137.0	136.0	138.0	132.0	135.0	133.0	134.0	131.0	132.0
90	132.0	133.0	133.0	136.0	130.0	132.0	131.0	133.0	127.0	129.0	129.0	131.0	126.0	127.0	127.0	130.0	123.0	125.0	124.0	128.0	121.0	123.0
95	123.0	124.0	124.0	127.0	121.0	123.0	123.0	125.0	119.0	120.0	120.0	122.0	117.0	119.0	119.0	122.0	114.0	117.0	116.0	119.0	113.0	115.0
100	115.0	116.0	116.0	119.0	113.0	115.0	115.0	117.0	111.0	112.0	112.0	114.0	109.0	111.0	111.0	114.0	107.0	109.0	108.0	111.0	105.0	107.0
105	107.0	109.0	109.0	111.0	106.0	107.0	108.0	109.0	103.0	105.0	105.0	107.0	102.0	104.0	104.0	107.0	99.6	102.0	101.0	104.0	98.5	100.0
110	101.0	102.0	102.0	105.0	99.4	101.0	101.0	103.0	96.8	98.2	98.6	100.0	95.7	97.0	97.4	100.0	93.1	95.5	95.0	97.9	92.1	93.5
115	94.4	95.6	95.9	98.4	93.3	94.5	94.9	96.6	90.8	92.1	92.5	94.3	89.6	90.9	91.4	94.0	87.2	89.5	89.1	91.9	86.2	87.5
120	88.6	89.7	90.3	92.6	87.6	88.8	89.3	90.9	85.2	86.3	87.0	88.6	84.1	85.3	85.9	88.5	81.7	83.9	83.5	86.3	80.7	82.0
125	82.8	83.8	84.9	87.1	82.2	83.2	84.0	85.6	80.0	81.1	81.8	83.3	78.9	80.1	80.7	83.3	76.6	78.7	78.5	81.1	75.6	76.9
130	77.5	78.2	79.5	81.5	76.6	77.7	79.0	80.4	74.9	76.0	77.0	78.5	74.1	75.1	75.9	78.4	71.9	73.9	73.8	76.3	71.0	72.1
135	72.3	73.3	74.4	76.3	71.8	72.7	73.9	75.2	70.0	70.9	72.3	73.6	69.3	70.2	71.5	73.7	67.4	69.2	69.4	71.8	66.6	67.6
140	67.6	68.3	69.7	71.5	67.0	68.0	69.2	70.3	65.5	66.4	67.6	68.9	64.8	65.5	66.9	68.9	62.9	64.7	65.2	67.4	62.3	63.3
145	63.3	64.1	65.4	67.2	62.8	63.5	64.9	65.9	61.0	62.0	63.2	64.4	60.5	61.4	62.6	64.5	58.8	60.4	60.9	63.0	58.2	59.0
150	59.3	59.9	61.2	63.1	58.7	59.5	60.8	62.0	57.1	57.9	59.3	60.3	56.4	57.2	58.6	60.5	54.7	56.4	56.9	58.9	54.3	55.1
155	55.5	56.3	57.6	59.2	55.0	55.6	57.0	58.1	53.2	54.1	55.4	56.6	52.7	53.5	54.9	56.7	51.1	52.5	53.3	55.1	50.4	51.4
160	52.0	52.6	53.9	55.7	51.5	52.2	53.6	54.5	49.8	50.5	52.0	52.9	49.2	50.0	51.2	53.2	47.6	49.1	49.8	51.7	47.1	47.8
165	48.8	49.4	50.7	52.2	48.2	48.8	50.2	51.2	46.5	47.3	48.7	49.7	46.0	46.7	48.1	49.7	44.3	45.8	46.4	48.3	43.8	44.6
170	45.7	46.2	47.5	49.2	45.1	45.8	47.2	48.0	43.5	44.1	45.5	46.5	42.9	43.6	44.9	46.7	41.3	42.8	43.4	45.1	40.7	41.4
175	42.8	43.4	44.7	46.1	42.3	42.8	44.1	45.1	40.6	41.3	42.7	43.6	40.1	40.7	42.1	43.7	38.4	39.8	40.4	42.3	37.9	38.6
180	40.1	40.6	41.9	43.4	39.6	40.2	41.5	42.3	37.9	38.5	39.9	40.8	37.4	38.0	39.4	41.0	35.8	37.1	37.8	39.4	35.2	35.9
185	37.6	38.1	39.4	40.7	37.0	37.5	38.9	39.7	35.4	36.0	37.4	38.1	34.9	35.4	36.7	38.4	33.2	34.6	35.2	36.9	32.7	33.3
190	35.2	35.7	36.9	38.3	34.6	35.2	36.5	37.2	33.0	33.5	34.8	35.7	32.5	33.1	34.4	35.9	30.8	32.1	32.8	34.4	30.2	30.9
195	32.9	33.4	34.7	35.9	32.4	32.8	34.1	34.9	30.7	31.3	32.6	33.3	30.2	30.7	32.0	33.6	28.6	29.9	30.5	32.1	28.1	28.6
200	30.8	31.2	32.5	33.8	30.2	30.7	32.0	32.6	28.6	29.0	30.4	31.2	28.1	28.6	29.9	31.3	26.4	27.6	28.3	29.9	25.9	26.5
205	28.7	29.2	30.4	31.6	28.2	28.6	29.9	30.6	26.5	27.0	28.4	29.0	26.1	26.5	27.8	29.3	24.4	25.6	26.3	27.7	23.9	24.4
210	26.9	27.3	28.4	29.7	26.3	26.7	28.0	28.6	24.6	25.0	26.4	27.1	24.1	24.6	25.9	27.2	22.6	23.6	24.3	25.8	22.1	22.6
215	25.0	25.4	26.6	27.8	24.5	24.8	26.1	26.7	22.8	23.3	24.6	25.1	22.4	22.7	24.0	25.4	21.0	22.0	22.6	23.9	20.4	20.9
220	23.3	23.7	24.8	26.0	22.7	23.1	24.4	24.9	21.2	21.6	22.8	23.4	20.9	21.2	22.4	23.6	19.4	20.4	21.0	22.3	19.0	19.4
225	21.8	22.0	23.2	24.3	21.3	21.6	22.7	23.3	19.8	20.2	21.3	21.8	19.4	19.7	20.9	22.0	18.1	19.0	19.5	20.6	17.6	17.9
230	20.4	20.7	21.7	22.7	19.9	20.2	21.2	21.7	18.5	18.8	19.9	20.4	18.1	18.4	19.5	20.5	16.7	17.6	18.2	19.3	16.3	16.6
235	19.2	19.4	20.4	21.3	18.6	18.9	19.9	20.4	17.2	17.5	18.6	19.0	16.8	17.1	18.2	19.2	15.5	16.3	16.9	17.9	15.0	15.3
240	17.9	18.2	19.1	20.0	17.4	17.7	18.7	19.1	16.0	16.2	17.4	17.8	15.6	15.9	17.0	17.9	14.2	15.1	15.6	16.7	13.8	14.1
245	16.7	17.0	18.0	18.8	16.3	16.5	17.5	17.9	14.7	14.9	16.2	16.6	14.4	14.7	15.8	16.7	12.9	13.8	14.4	15.5	12.5	12.8
250	15.5	15.8	16.9	17.6	15.0	15.3	16.4	16.7	13.4	13.6	15.0	15.4	13.2	13.4	14.6	15.6	11.5	12.6	13.3	14.3	11.2	11.5
255	14.3	14.6	15.8	16.5	13.7	14.0	15.3	15.6	12.1	12.4	13.8	14.3	12.0	12.2	13.6	14.5	10.2	11.2	12.2	13.2	9.8	10.1
260	13.1	13.4	14.7	15.5	12.4	12.8	14.1	14.5	10.7	11.1	12.6	13.0	10.7	10.9	12.4	13.4	9.0	9.9	10.9	12.1	8.5	8.8
265	12.0	12.2	13.5	14.3	11.3	11.6	13.0	13.4	9.6	9.9	11.4	11.8	9.5	9.7	11.2	12.3	7.8	8.7	9.6	10.9	7.3	7.6
270	10.8	11.1	12.4	13.2	10.1	10.4	11.7	12.2	8.4	8.7	10.2	10.7	8.3	8.5	10.0	11.1	6.6	7.6	8.4	9.7	6.1	6.4
275		10.0	11.3	12.1	9.0	9.3	10.6	11.0	7.4	7.6	9.1	9.5	7.2	7.4	8.9	10.0		6.4	7.2	8.4		
280			10.2	11.0	8.0	8.2	9.6	9.9	6.3	6.5	7.9	8.4	6.2	6.4	7.9	8.8			6.2	7.3		
285			9.1	10.0			8.6	8.9			6.9	7.4			6.8	7.7				6.2		
290			8.2	8.9			7.6	7.8			5.9	6.3			5.8	6.6						
295				7.9			6.6	6.8								5.7						
300							5.7	5.9														

# Lifting heights Hauteurs de levage

**SL8F**

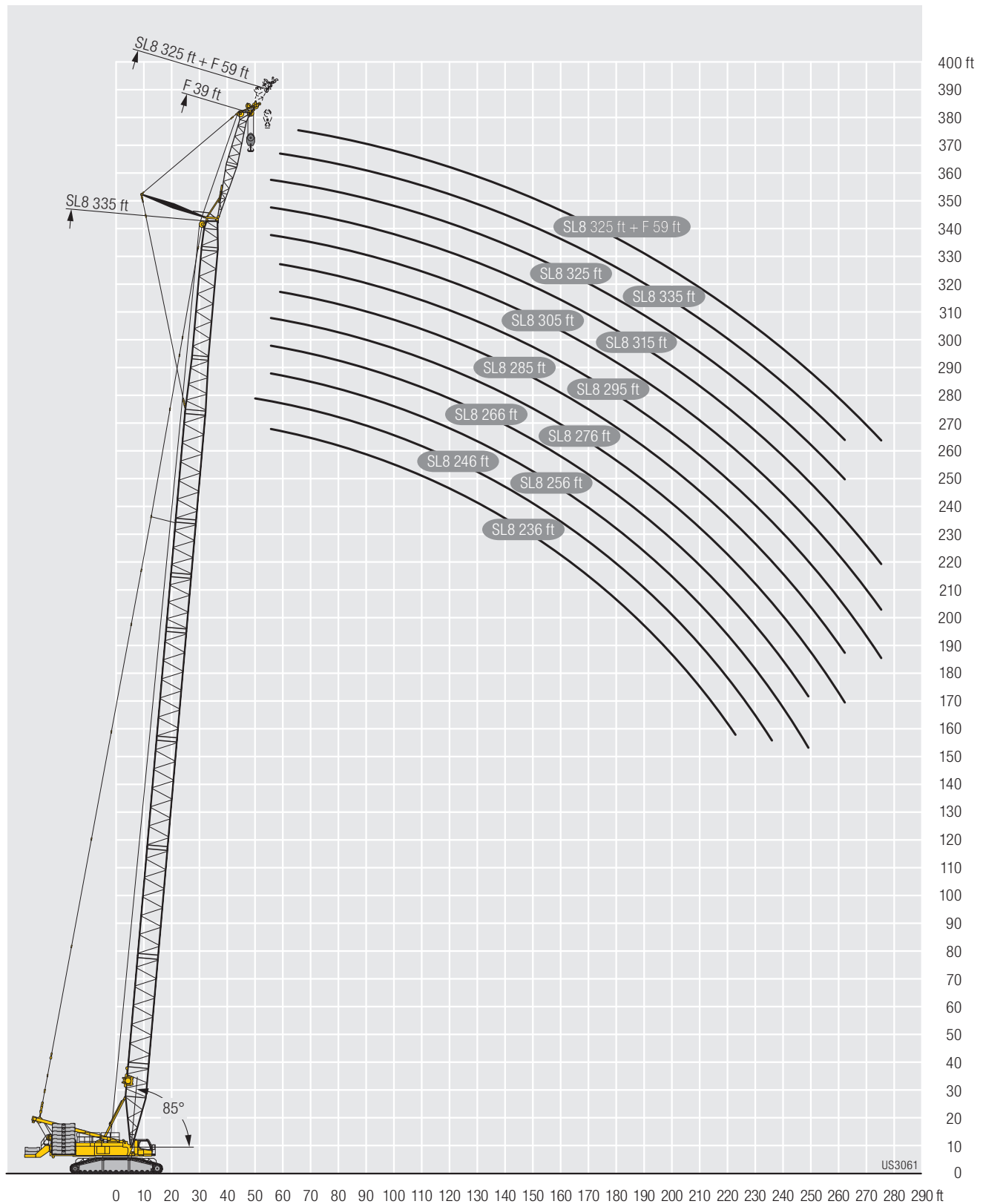

# Description of symbols Explication des symboles

## General symbols/Symboles généraux



Hoist gear  
Treuil de levage



Hookblock / Capacity  
Moufle à crochet / Capacité de charge



Slewing speeds  
Vitesses d'orientation



Page  
Page



Radius  
Portée



Central ballast  
Contrepoids central



Driving speed  
Vitesse de translation



Counterweight  
Contrepoids

## Crane specific symbols/Symboles spécifiques à la grue



Max. boom length  
Longueur maxi. de la flèche principale



Derrick system D  
Système derrick D



Max. boom system length  
Longueur maxi. du système de flèche



Fixed lattice jib F  
Fléchette à treillis fixe F



Width crawler chassis  
Largeur du train de chenilles



Lattice type luffing fly jib W  
Fléchette treillis à volée variable W



Main boom S  
Flèche principale S



Counterweight frame B  
Palette de lest B



Main boom SL  
Flèche principale SL



Extension of slewing platform ballast  
Extension de lest de partie tournante

## Remarks referring to load charts

1. The lifting capacities do not exceed 75 % of the tipping load according to ASME B 30.5. The crane's structural steelwork is in accordance with EN 13000 and ASME B 30.5.
2. For the calculation of the load charts at least a wind speed of 29 ft/s (9 m/s, 20.1 miles/hour) and regarding the load a sail area of 1 m<sup>2</sup> per ton load and a wind resistance coefficient of 1.2 on the load have been taken into account. For lifting of loads with large sail areas and/or high wind resistance coefficients the maximum wind speed as stated in the load charts has to be reduced.
3. Lifting capacities are given in kips.
4. The weight of the hook blocks and hooks is part of the load and therefore it must be deducted from the lifting capacities.
5. The working radii are measured from the slewing centreline.
6. The subsoil must be even and of good bearing capacity.
7. Subject to modification of lifting capacities.
8. The data of this brochure serves only for general information. All information is provided without warranty. Instructions for the correct commissioning of the crane please take from the operation manual and the load chart book.

## Remarques relatives aux tableaux des charges

1. La capacité de charge ne doit pas dépasser 75 % de la charge de basculement conformément à ASME B 30.5. La structure métallique de la grue est conforme à EN 13000 et ASME B 30.5.
2. Une vitesse de vent de 29 ft/s (9 m/s, 20.1 miles/hour) minimum, une surface de prise au vent de 1 m<sup>2</sup> par tonne ainsi qu'un coefficient de résistance au vent de la charge 1,2 sont pris en compte pour le calcul des tableaux de charge. Lorsque des charges ayant une surface de prise au vent et/ou un coefficient de résistance au vent plus élevé(e)(s) sont levées, la vitesse de vent maximale indiquée dans les tableaux de charge doit être réduite.
3. Les charges sont indiquées en kips.
4. Le poids du crochet de levage resp. de la moufle à crochet est une partie de la charge et doit donc être déduit de la capacité de charge.
5. Les portées sont prises à partir de l'axe de rotation de la partie tournante.
6. Le sol doit être plat et résistant.
7. Charges données sous réserve de modification.
8. Les données de cette brochure sont données à titre informatif. Ces renseignements sont sans garantie. Les consignes relatives à la bonne mise en service de la grue sont disponibles dans le manuel d'utilisation et le manuel de tableaux de charge.