



1200 USt



551 ft



354 ft +
374 ft



551 kip



286 kip



992 kip



30 ft

Stays strong when things get tight.

LR 11000

Crawler Crane
Grue sur chenilles

LIEBHERR

Mobile and Crawler Cranes

BUCKNER
HEAVYLIFT CRANES
www.bucknerheavylift.com | 336.376.8888
f @ in



Technical Data

Caractéristiques technique

Equipment	
Equipement	4-5
Dimensions	
Encombrement	6-10
Crane data	
Dates de la grue	11
Transportation plan	
Plan de transport	12-13
Boom/jib combinations	
Configurations de flèche	14-21
SL	22-23
S2	24-25
SDB/SDBV/SDBW	26-27
SL2DB/SL2DB2/SL2DBW	28-30
S2DB/S2DB2/S2DBW	31-32
PDB/PDBW	33-34
SW1	35-39
SDWB/SDWBV/SDWBW	40-65
PDW3B/PDW3BW	66-86
SL8F2	87-91
SL10DF2B/BV	92-95
SL9	96-97
SL11DB/BV	98-99
Description of symbols	
Explication des symboles	100
Remarks	
Remarques	101
Customer Service	102

Equipment

Max. capacity	2205 kip at 36 ft radius SDBW – System with S 138 ft and D 118 ft.
Max. load moment	112,000,000 lb-ft – 1038 kip at 105 ft radius. SL2DBW – System with S 217 ft and D 138 ft.

Crawler travel gear

Crawler chassis	Liebherr crawler chassis consisting of one centre section and two crawler carriers with crawler plates 6.5 ft (optional 7.9 ft) and quadruple drive.
Central ballast	2 brackets 11,025 lb each. 8 ballast plates 22,050 lb each. Total central ballast 198.4 kip (optional 286,6 kip).



Crane superstructure

Superstructure frame	Liebherr slewing platform frame, consisting of the slewing platform with winch IV and removable SA frame and roller turning connection.
Crane engine	8-cylinder diesel engine, make Liebherr, watercooled, rated power 500 kW (680 h.p.), max torque 2335 lb-ft. Fuel tank approx. 396 gallons, exhaust emission according to directive 97/68/EG and EPA/CARB.
Winch I	Standard hoist drum, hydraulically driven by axial-piston swivel pumps with integrated planetary gear.
Winch IV	Boom hoist.
Reeving winch	Auxiliary winch for the reeving of ropes.
Slewing gear	2 slewing gears, hydraulically powered by axial-piston swivel pump, with integrated planetary gear.
Crane cabin	Air conditioned crane cabin tiltable to the rear with safety glazing, heat insulating glass, roof window with bullet proof glass, standardized control units ergonomically positioned. Additional thermostatically controlled hot water heating.
Crane control	All crane movements are initiated by means of two 4-way joystick hand levers and two 2-way hand/foot levers. All working movements are independently controllable.
Safety devices	Hoist limit switch. Safety valves against hose and pipe rupture. Drum switch limit at 3 rest layers. Wind speed gauge. Electronic inclination indicator. Aircraft warning control light.
Camera observation	2 colour-screens, 3 cameras for winches and rear area.
Counterweight	2 brackets 11,025 lb each. Total counterweight at superstructure 551.15 kip. 24 ballast plates 22,050 lb each (option).



Boom system

Main boom S	System S3228 with head section for max. 2205 kip load capacity. Boom length SDB 138 ft – 354 ft with derrick system.
Main boom S2	System S3228 with head section for max. 1433 kip load capacity. Boom length S2 59 ft – 335 ft. Boom length S2DB 138 ft – 512 ft with derrick system.
Main boom P	System L2722/S3228 with head section for max. 2205 kip load capacity. Boom length PDB 157 ft – 453 ft. Boom length PDB2/BW 157 ft – 512 ft.
Main boom SL	System S3228/L2722 with head section for max. 1433 kip load capacity. Boom length SDB 59 ft – 374 ft.
Main boom SL2	System S3228/L2722 with head section for max. 1433 kip load capacity. Boom length SL2DB 138 ft – 512 ft.
Main boom SL8	System S3228/L2722 with fixed lattice jib F2, boom length SL8 276 ft – 354 ft, boom length SL8 335 ft – 433 ft.
Main boom SL9	System S3228/L2722 with head section for maximum lifting capacity of 1433 kip. Boom length of SL9 256 ft – 335 ft boom length of SL9D 315 ft – 413 ft.
Main boom SL10	System S3228/L2722 with fixed lattice jib F2, boom length SL10 236 ft – 551 ft
Main boom SL11	System S3228/L2722 with head section for maximum lifting capacity of 1433 kip. Boom length of SL11D 217 ft – 532 ft.
Fixed lattice fly jib F2	For maximum lifting capacity of 557 kip and integral runner, can be attached at angles of 10°, 15° and 20°, boom length F 39 ft – F 128 ft.
Lattice type luffing fly jib W	System S3228/L2722 with head section for max. 1433 kip load capacity. Luffing jib lengths 98 ft – 374 ft.
Derrick system D	System 2825 including guy rods.
Counterweight frame B	For max. derrick counterweight of 992 kip, for infinitely variable radius from 39 ft – 66 ft. Max. radius of 98 ft only with guiding frame (B2).
V-frame BV	For max. derrick ballast of 992 kip and infinitely variable radii from 43 ft – 98 ft.
Counterweight trailer BW	For maximum derrick ballast of 992 kip with a maximum radius of 98 ft, for infinitely variable radii of 43 ft – 59 ft, 56 ft – 72 ft, 69 ft – 85 ft, 82 ft – 98 ft.
Derrick-Counterweight	Ballast pallet with VarioTray (option). 22,050 lb counterweight slabs for a total weight of 992 kip.
Winch II	Second hoist winch.
Winch III	Reeving main boom / Derrick operation.
Winch V	Luffing for W-jib configuration.
Winch VI	Auxiliary hoist gear.
Whip line 70,550 lb	For attaching to the S or L head.

Additional equipment

Mechanical outriggers	For erecting long boom combinations without derrick system.
Hydraulic assembly jacks	Lifting of the basic machine for assembly/disassembly. Consisting of 4 lifting cylinders with supporting plates, installed on the centre part.
Hydraulic assembly cylinder	For assembly/disassembly of the crawler carrier by the crane itself.
Pin pulling device	Including mobile hydraulic aggregate. For assembly/disassembly of the pins at the crawler chassis and centre part as well as the boom sections.

Other items of equipment available on request. Standard equipment and options according to effective price list.

Équipement

Capacité max.	2205 kip pour une portée de 36 ft. Système SDBW avec S 138 ft et D 118 ft.
Couple de charge max.	112,000,000 lb-ft – 1038 kip pour une portée de 105 ft. Système SL2DBW avec S 217 ft et D 138 ft.

Train de chenilles

Mécanisme de translation	Le train de chenilles Liebherr est composé d'une partie centrale et de deux longerons avec patins de chenilles 6.5 ft (en option 7.9 ft) et un entraînement à 4 positions.
Contrepoids central	2 consoles de 11,025 lb. 8 plaques de lest de 22,050 lb. Contrepoids central total 198.4 kip (en option 286.6 kip).



Partie tournante

Cadre de la partie tournante	Châssis de plate-forme tournante Liebherr, composé d'une plate-forme tournante avec treuil IV, chevalet SA amovible et couronne d'orientation à rouleaux.
Moteur de la grue	Diesel Liebherr 8 cylindres, refroidissement par eau, puissance 500 kW (680 ch), couple de rotation max. 2335 lb-ft. Réservoir de carburant: env. 396 gallons. Emissions polluantes conformes aux normes 97/68/EG et EPA/CARB.
Treuil I	Treuil de levage standard, il est entraîné hydrauliquement par des pompes à débit variable à pistons axiaux avec réducteur planétaire intégré.
Treuil IV	Mécanisme de relevage.
Treuil de mouflage	Treuil auxiliaire pour le mouflage des câbles.
Mécanisme d'orientation	Deux mécanismes d'orientation, il est entraîné hydrauliquement par des pompes à débit variable à pistons axiaux avec réducteur planétaire intégré.
Cabine du grutier	La cabine du grutier est climatisée, inclinable vers l'arrière, possède un vitrage de sécurité, un vitrage isolant thermiquement, une fenêtre de toit en verre blindé, des unités de commande normalisées disposées de façon ergonomique. Chauffage d'appoint et chauffage de l'eau régulé thermostatiquement.
Commande de la grue	Tous les mouvements de la grue sont commandés par deux manipulateurs à 4 voies et deux pédale/levier à 2 voies. Tous les mouvements de travail peuvent être commandés indépendamment.
Dispositifs de sécurité	Interrupteur de fin de course. Clapets de sécurité contre les ruptures de tuyaux et de flexibles. Coupure de fin de course du tambour avec 3 enroulements de sécurité. Anémomètre de sécurité. Inclinomètre électronique. Balise aérienne.
Contrôle vidéo	2 écrans couleur, 3 caméras pour la zone de treuils et la partie arrière.
Contrepoids	2 consoles de 11,025 lb chacune. Contrepoids total 551.15 kip. 24 plaques de lest à 22,050 lb (option).



Système de flèche

Flèche principale S	Système S3228 avec élément de tête pour une capacité max. de 2205 kip. Longueur de la flèche SDB 138 ft – 354 ft avec système derrick.
Flèche principale S2	Système S3228 avec élément de tête pour une capacité max. de 1433 kip. Longueur de la flèche S2 59 ft – 335 ft. Longueur de la flèche S2DB 138 ft – 512 ft avec système derrick.
Flèche principale P	Système L2722/S3228 avec élément de tête pour une capacité max. de 2205 kip. Longueur de la flèche PDB 157 ft – 453 ft. Longueur de la flèche PDB2/BW 157 ft – 512 ft.
Flèche principale SL	Système S3228/L2722 avec élément de tête pour une capacité max. de 1433 kip. Longueur de la flèche SL 59 ft – 374 ft.
Flèche principale SL2	Système S3228/L2722 avec élément de tête pour une capacité max. de 1433 kip. Longueur de la flèche SL2DB 138 ft – 512 ft.
Flèche principale SL8	Système S3228/L2722 avec pointe de flèche en treillis fixe F2. Longueur de flèche SL8 276 ft – 354 ft, longueur de flèche SL8 335 ft – 433 ft.
Flèche principale SL9	Système S3228/L2722 avec élément de tête pour une capacité de charge de 1433 kip. Longueur de flèche SL9 256 ft – 335 ft. Longueur de flèche SL9D 315 ft – 413 ft.
Flèche principale SL10	Système S3228/L2722 avec pointe de flèche en treillis fixe F2. Longueur de flèche SL10 236 ft – 551 ft.
Flèche principale SL11	Système S3228/L2722 avec élément de tête pour une capacité de charge de 1433 kip. Longueur de flèche SL11D 217 ft – 532 ft.
Fléchette treillis fixe F2	Pour capacité de charge maximale de 557 kip et extrémité de mât intégrée, montage possible sous 10°, 15°, 20°, longueur de flèche F 39 ft – F 128 ft.
Fléchette treillis à volée variable W	Système S3228/L2722 avec élément de tête pour une capacité max. de 1433 kip. Longueurs de flèche treillis 98 ft – 374 ft.
Système derrick D	Le système 2825 comprend des tirants.
Palette de lest B	Pour un contrepoids derrick max. de 992 kip et rayons variables progressivement de 39 ft – 66 ft. Rayon max. de 98 ft uniquement avec cadre de guidage (B2).
V-Frame BV	Pour un contrepoids derrick de 992 kip max. et des rayons variables progressivement de 43 ft – 98 ft.
Remorque à contrepoids BW	Pour un contrepoids derrick de 992 kip avec un rayon de 98 ft, pour des rayons variables progressivement de 43 ft – 59 ft, 56 ft – 72 ft, 69 ft – 85 ft, 82 ft – 98 ft.
Contrepoids derrick	Plaque lest avec VarioTray (Option). 22,050 lb de plaques de contrepoids pour un poids total de 992 kip.
Treuil II	2. treuil de levage.
Treuil III	Réglage flèche principale/mode derrick.
Treuil V	Réglage fléchette treillis à volée variable.
Treuil VI	Treuil de levage auxiliaire.
Poulies en extrémité de mât 70,550 lb	Pour le montage sur la tête S ou L.

Équipement additionnel

Stab. additionnel mécanique	Pour le relevage de longues combinaisons de flèches sans système de derrick.
Stabilisateurs hydrauliques de montage	Ils soulèvent l'engin de base pour le montage/démontage. Ils sont constitués de 4 vérins de calage dont les patins de calage montés sur l'élément central.
Vérin hydraulique de montage	Pour le montage autonome/démontage du train de chenilles.
Dispositif d'extraction des axes	Il est constitué du composant hydraulique mobile. Pour le montage/démontage des goujons au niveau des chenilles et de l'élément central ainsi que pour celui des pièces intermédiaires de la flèche.

D'autres équipements additionnels sont disponibles sur demande. Les équipements de série et les options correspondent à la liste de prix actuelle.

Dimensions

Encombrement

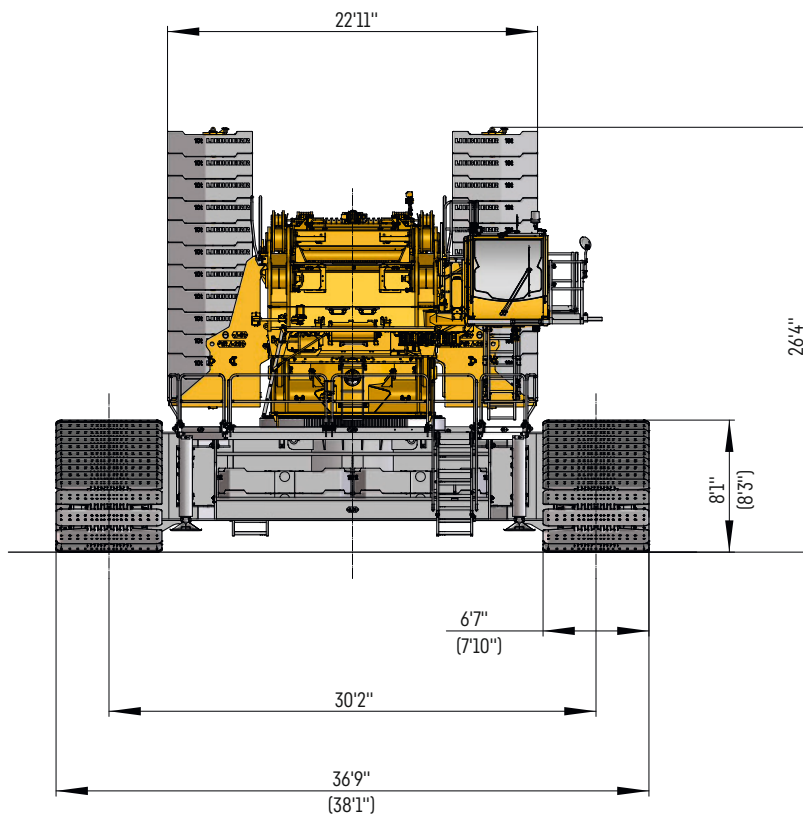
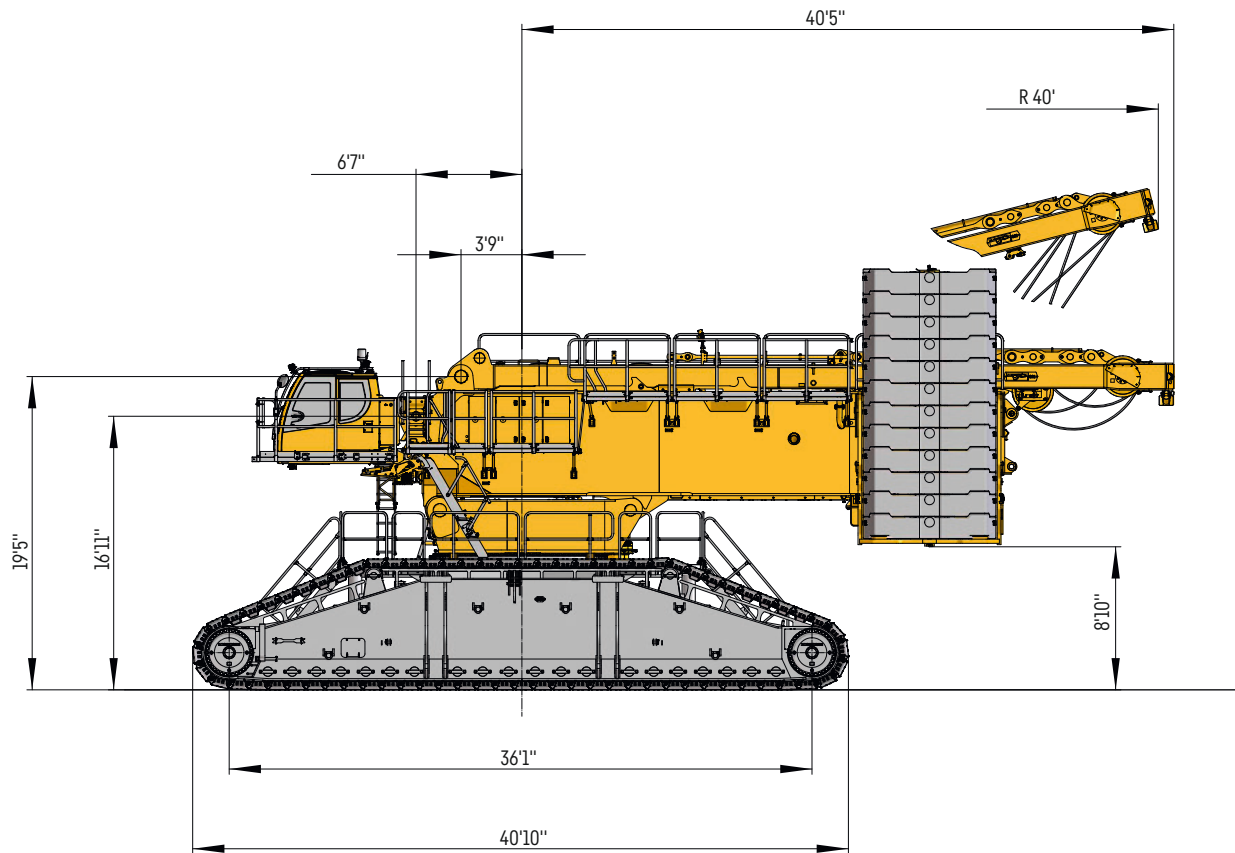

US235-0001-00

Dimensions

Encombrement

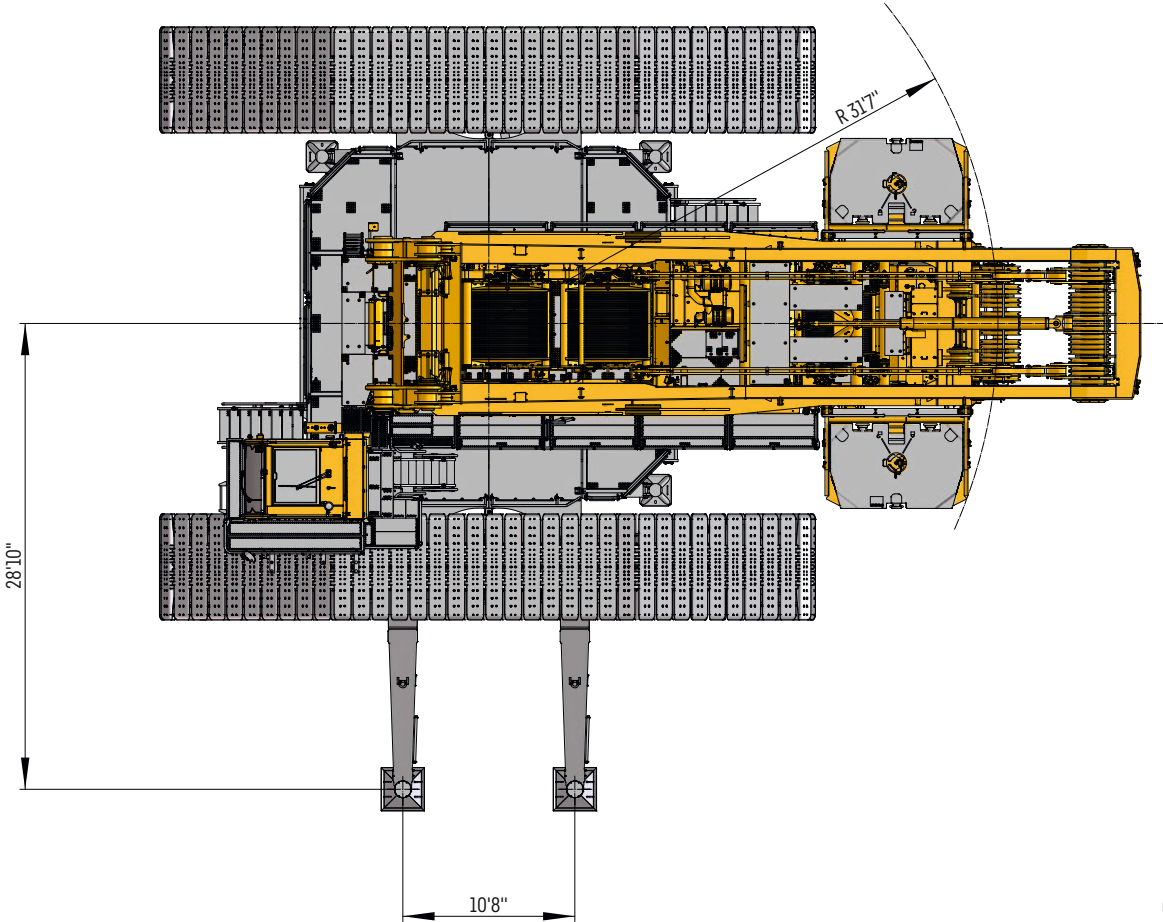

US235-0001-00

Dimensions

Encombrement

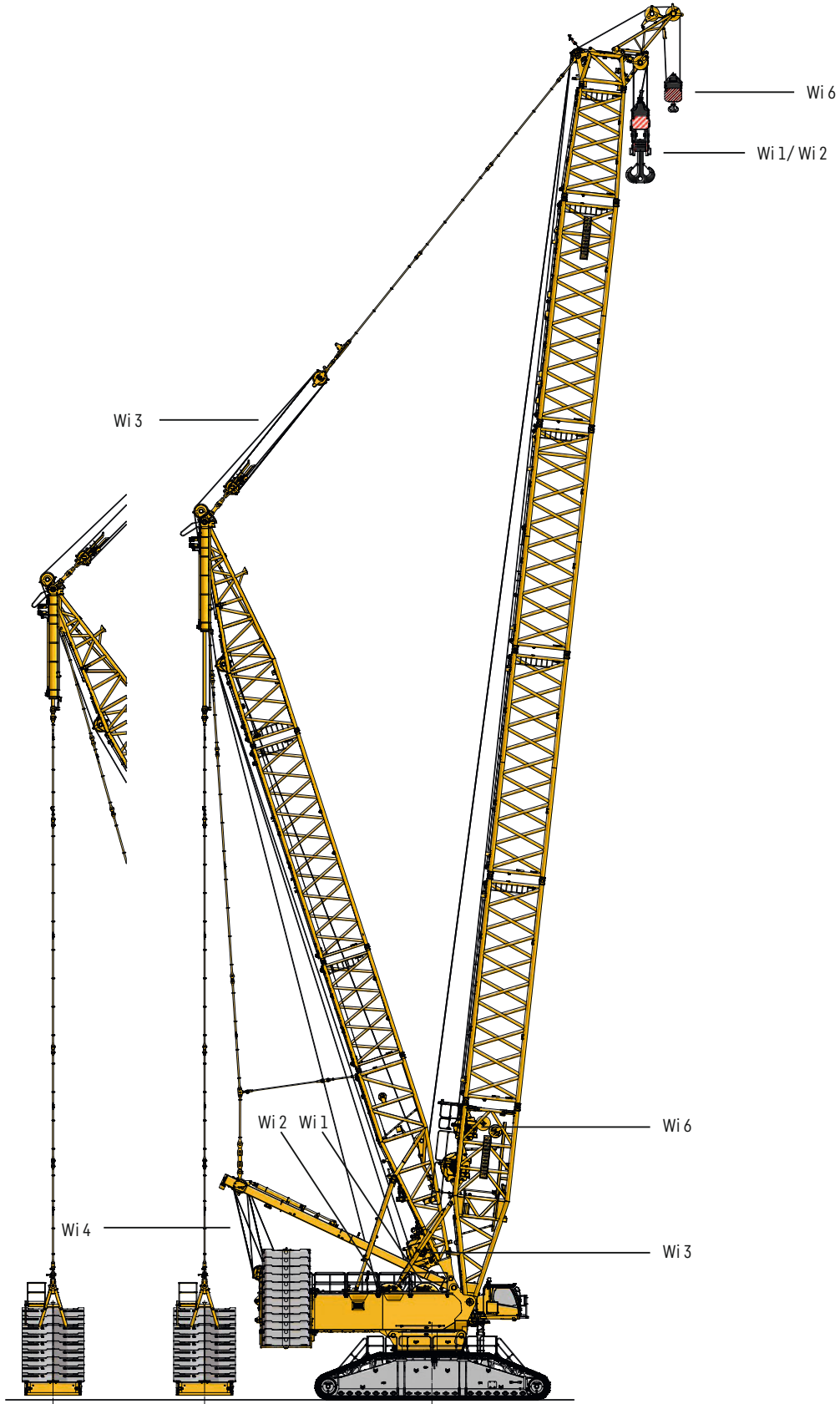

S235-0016-00

Dimensions

Encombrement

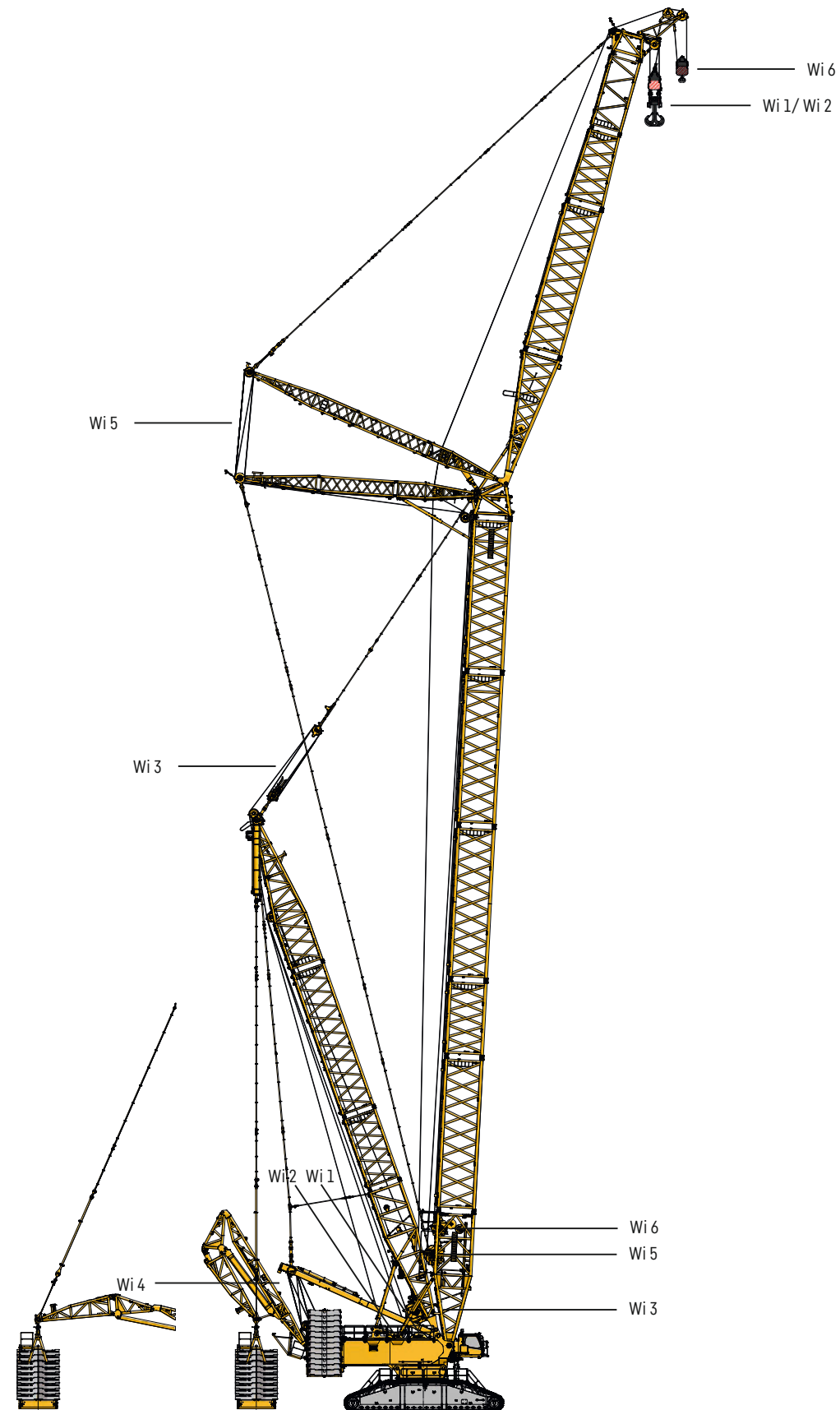

S235-0017-00

Dimensions

Encombrement



B 39 ft – 66 ft

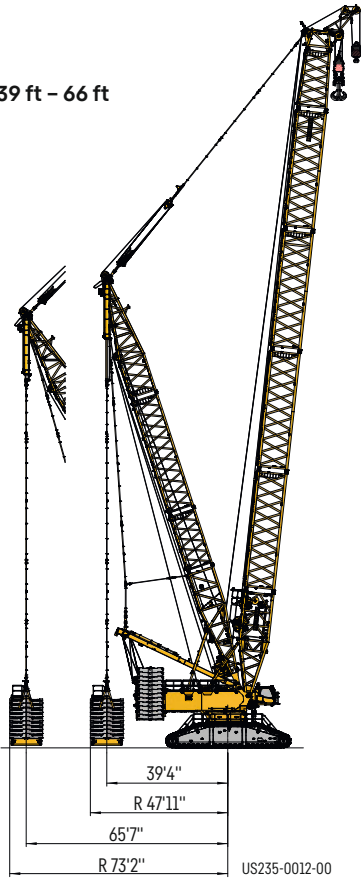

BV 43 ft – 98 ft

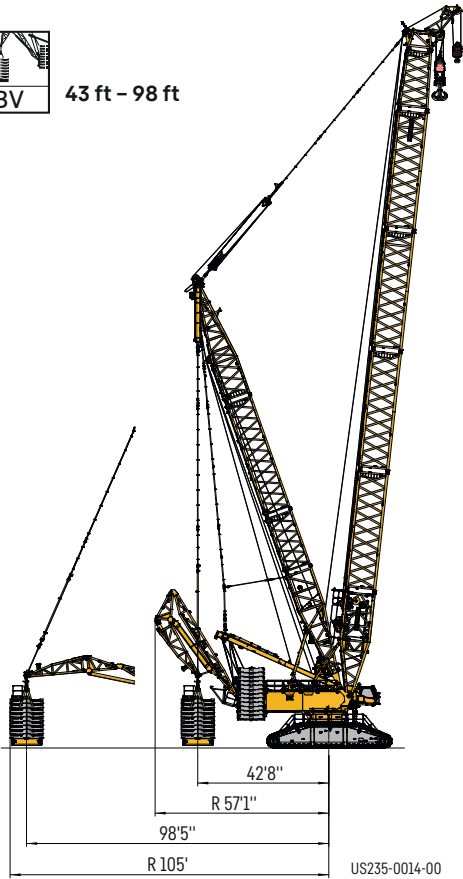

B2 66 ft, 82 ft, 98 ft







BW 43 ft – 98 ft





Crane data

Dates de la grue







Winches · Treuils

	V ft/min	 F	 ϕ	
1	0 - 394 ft/min	51,750 lb	1.2"	4757 ft
2	0 - 394 ft/min	51,750 lb	1.2"	4757 ft
3	0 - 377 ft/min	-	-	-
4	0 - 2 x 197 ft/min	-	-	-
5	0 - 345 ft/min	-	-	-
6	0 - 387 ft/min	36,000 lb	1.1"	1969 ft

Working speeds · Vitesses

	Slewing speeds · Vitesses d'orientation	0 - 0.89 rpm
	Travel speeds · Vitesses de translation	0 - 0.88 mph

Hook blocks · Moufles à crochet

		 ϕ			
2205 / 1212 kip (M)	2205 kip	1.2"	2 x 13	2 x 25	62,600 / 47,400 lb
2094 / 1058 kip	2205 kip	1.2"	2 x 11	2 x 23	56,225 - 65,050 lb / 43,000 - 51,800 lb
1763 / 881 kip	1763 kip	1.2"	2 x 9	2 x 19	35,300 - 57,320 lb / 26,500 - 48,500 lb
1433 / 716 kip	1433 kip	1.2"	2 x 7	2 x 15	30,900 - 48,500 lb / 22,050 - 39,700 lb
683 / 341 kip	705 kip	1.2"	2 x 3	2 x 7	10,350 - 28,000 lb / 7,500 - 25,125 lb
529 kip	551 kip	1.2"	5	11	6,600 - 24,250 lb
352 kip	352 kip	1.2"	3	7	5,500 - 18,750 lb
149 kip	176 kip	1.2"	1	3	5,500 - 9,920 lb
50 kip	55 kip	1.2"	-	1	3,300 lb

(M) = Module block · Moufle modulaire

Transportation plan

Plan de transport

Crawler middle section with rotating (3 slewing gears), width 11'6"

Partie centrale des chenilles avec système de rotation (3 mécanismes d'orientation), largeur 11'6"

59.96 kip*

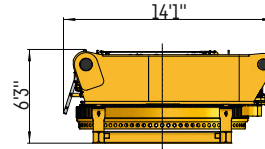

132.3 kip [146.6 kip*]

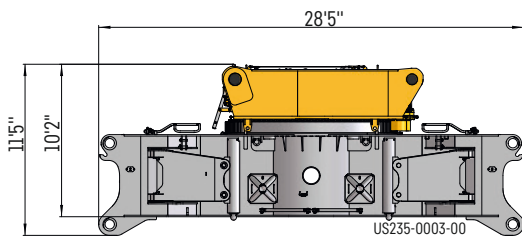

88.2 kip*

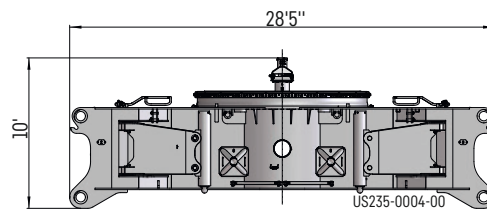

* Optional with quick connection · en option avec quick connection

Crawler incl. 2 driving gears

Longeron avec 2 mécanismes de translation

2 x 132.3 kip [2 x 147.7 kip]

6.5 ft (7.9 ft) Width · largeur

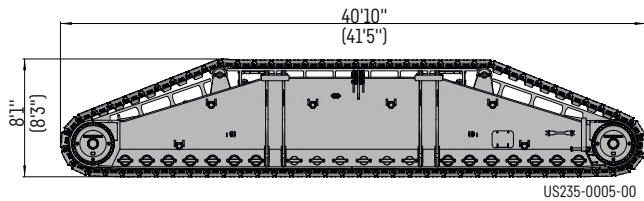

2 x 68.4 kip

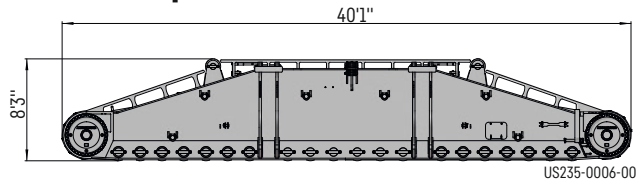

Winch 1/2

Treuil 1/2

30.87 kip

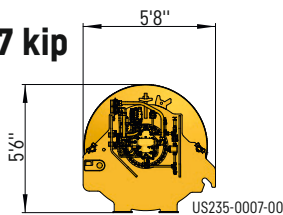

30.87 kip

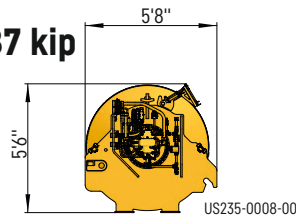

6'11" Width · largeur

Transportation plan

Plan de transport

Superstructure with SA-frame, winch 4, width

Partie tournante avec chevalet SA, treuil 4, largeur

171.96 kip

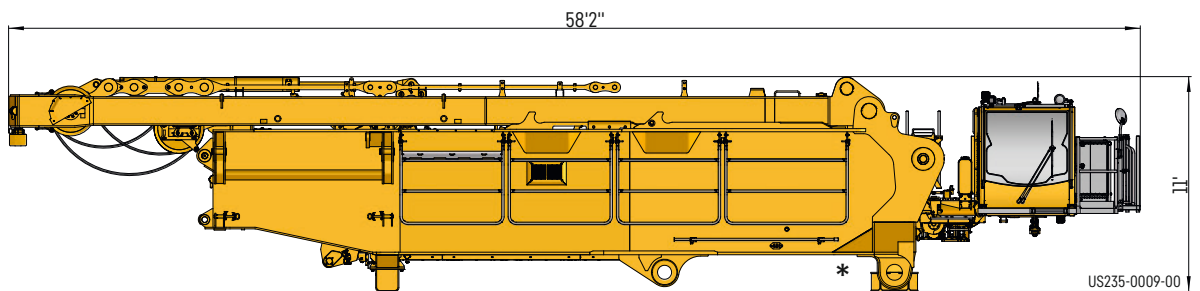

11'6" Width - largeur

* + 2000 lb Transport support · t pour le support de transport

Superstructure without SA-frame

Partie tournante sans chevalet SA

101.4 kip

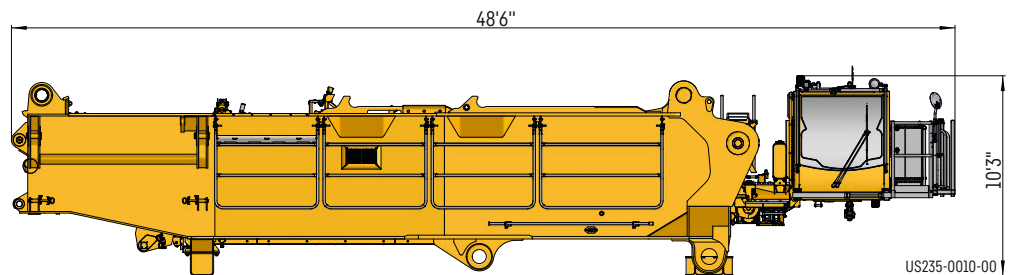

11'6" Width - largeur

* + 2000 lb Transport support · t pour le support de transport

SA-frame, winch 4 incl. rope and pulley block

Chevalet SA, treuil 4 incl. câble et bloc de poulies

72.75 kip

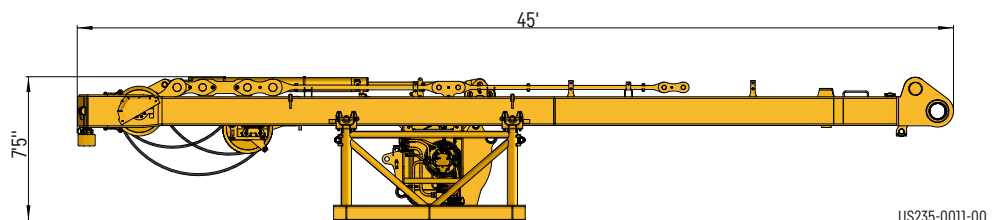

10'2" Width - largeur

* + 2000 lb Transport support · t pour le support de transport

Standard boom system

Systèmes de flèche standards

315 + 276

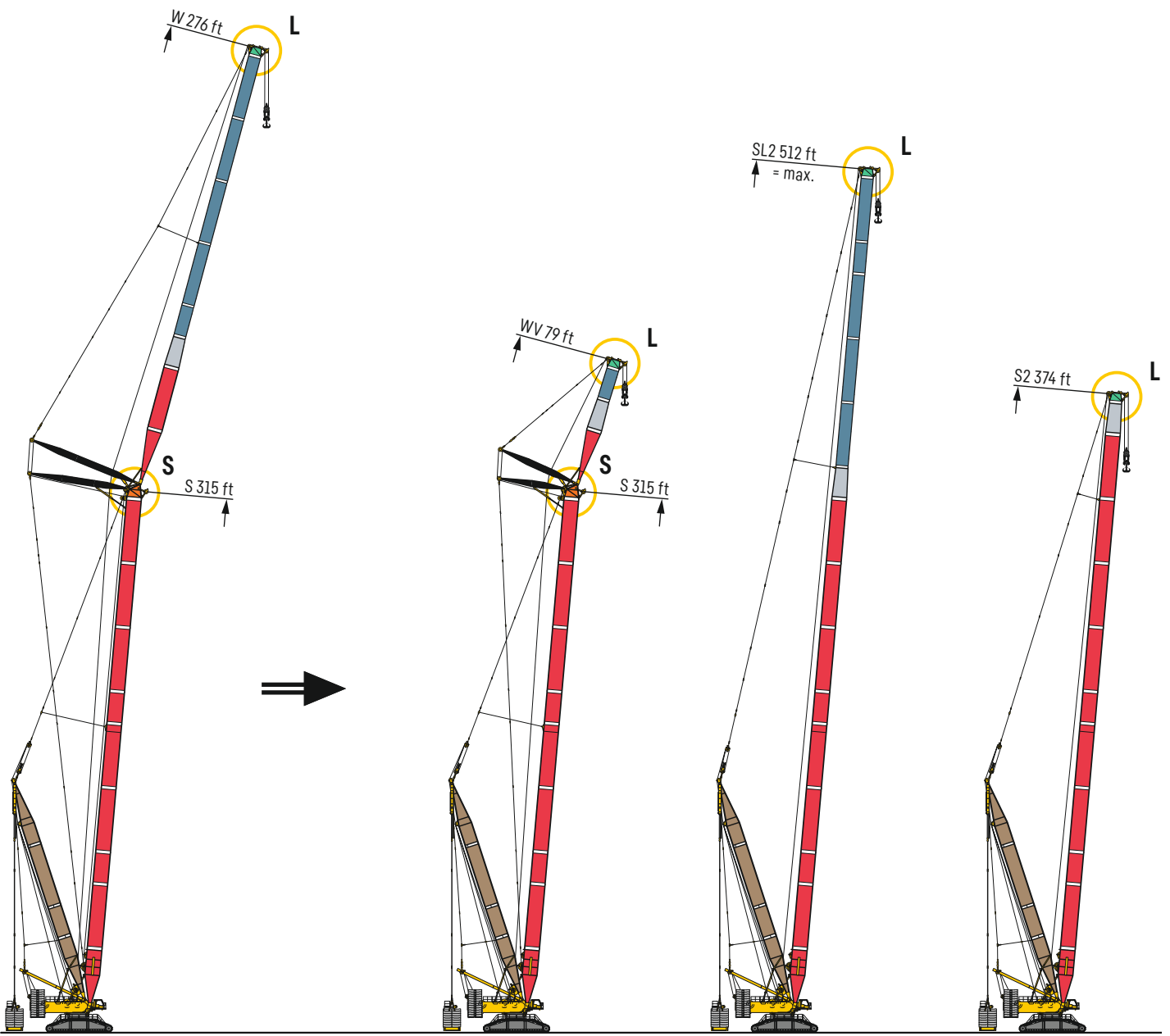
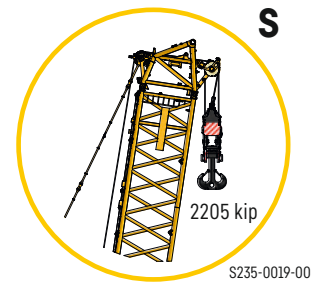
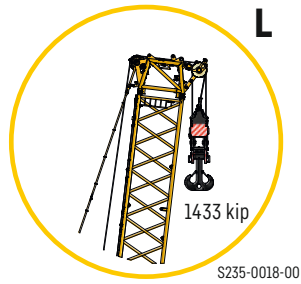
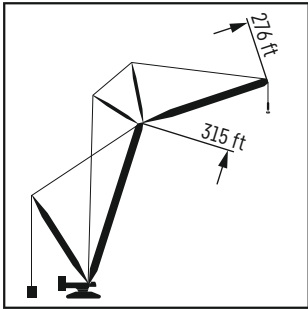

SDWB/BV/BW

S 138 ft - 354 ft
W 59 ft - 374 ft
D 118 ft - 138 ft

SDWVB/BV/BW

S 138 ft - 354 ft
W 59 ft - 79 ft
D 118 ft - 138 ft

SL2DB/BV/BW

SL2 138 ft - 512 ft
D 118 ft - 138 ft

S2DB/BW

S2 138 ft - 512 ft
D 118 ft - 138 ft

Standard boom system

Systèmes de flèche standards

315 + 276

S Main boom, heavy
Flèche principale, lourde

D Derrick
Flèche derrick

B/B2 Suspended ballast
Lest suspendu

S Main boom, heavy/light
Flèche principale, lourde/légère

W Luffing fly jib, heavy
Fléchette, lourde

P PowerBoom

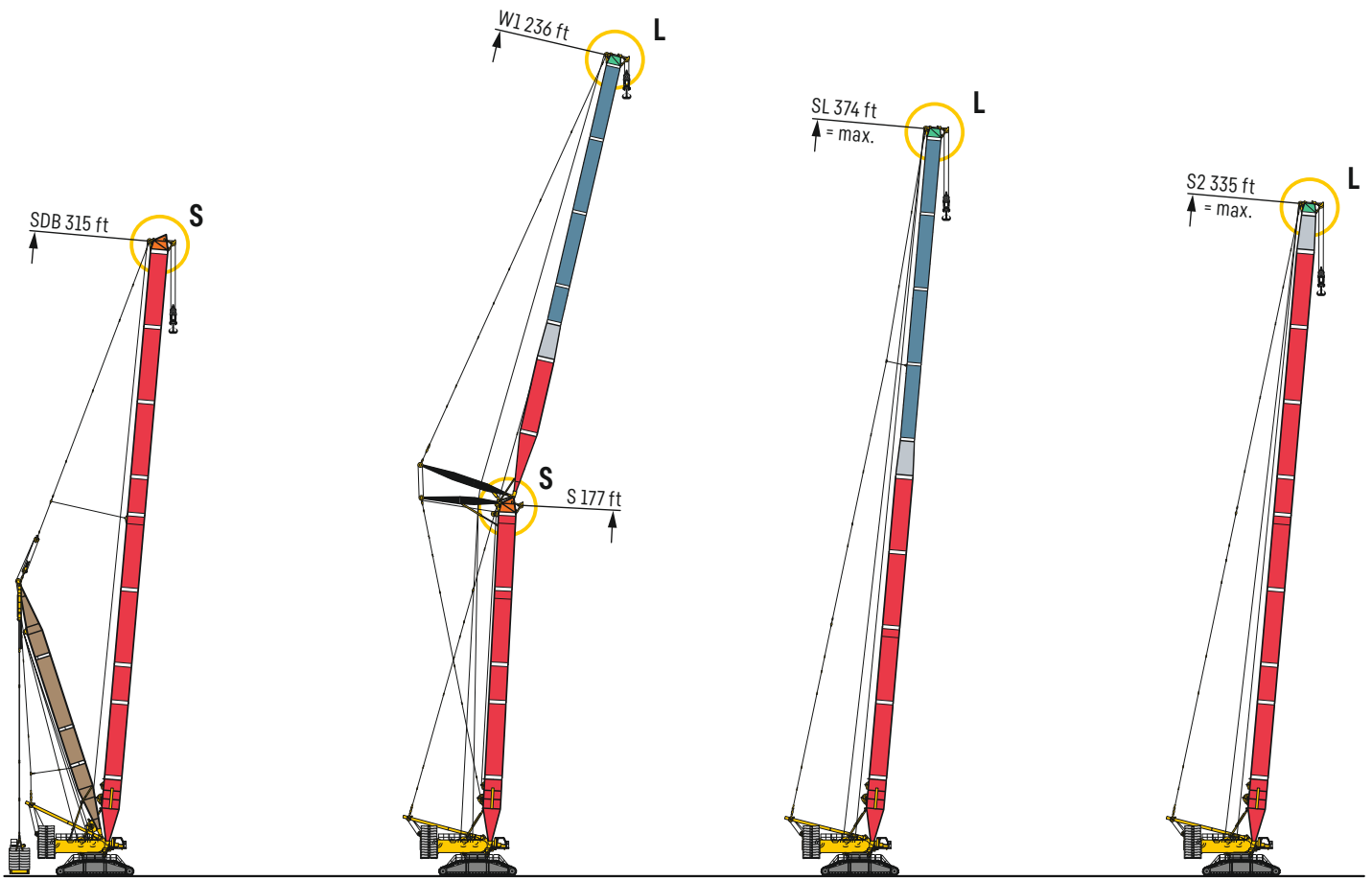

SDB/BV/BW

S 138 ft - 354 ft
D 138 ft

SW1

S 138 ft - 197 ft
W1 59 ft - 276 ft

SL

SL 59 ft - 374 ft

S2

S2 59 ft - 335 ft

US2799.01

Extended boom system

Systèmes de flèche étendus

354 + 374

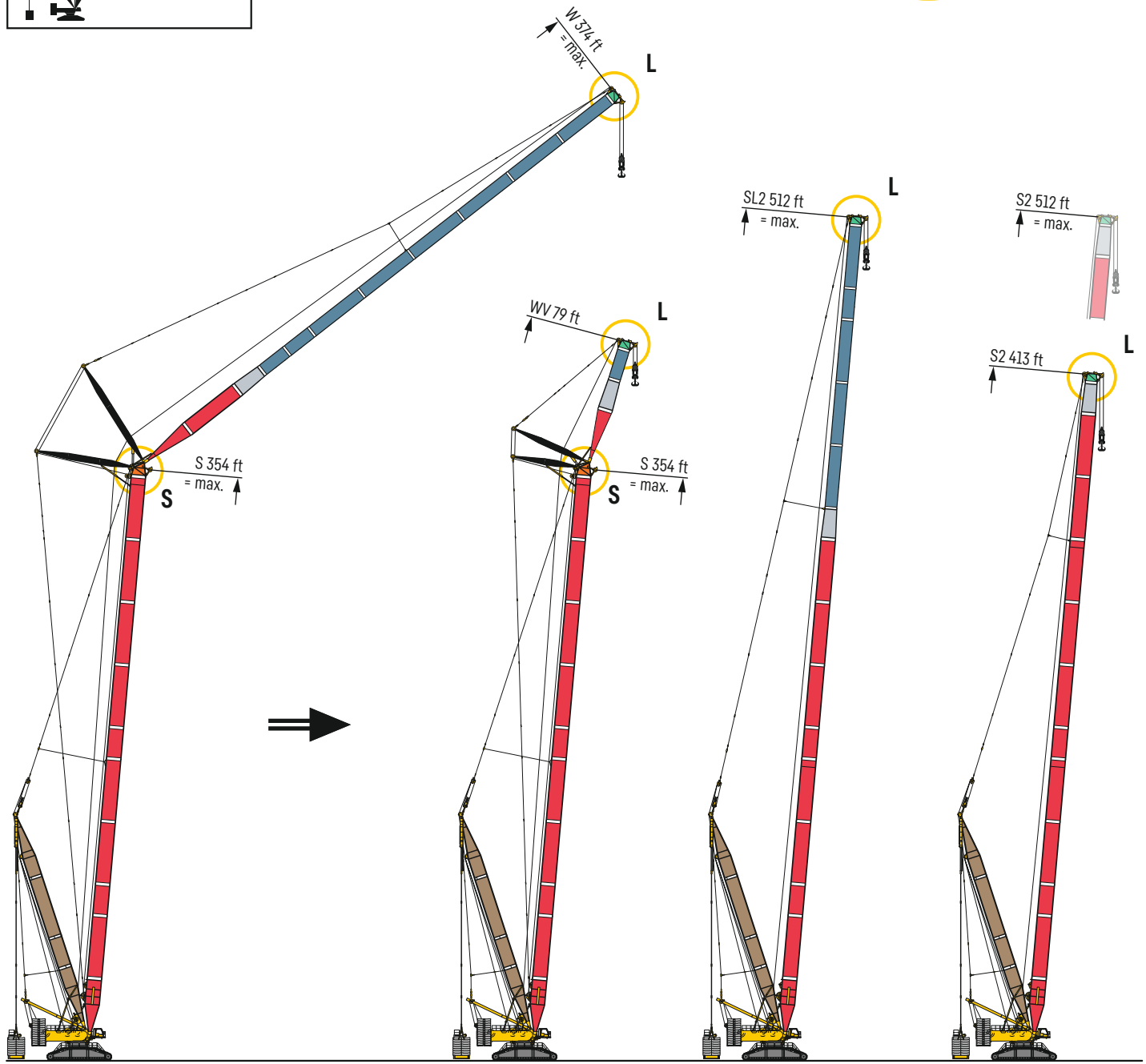
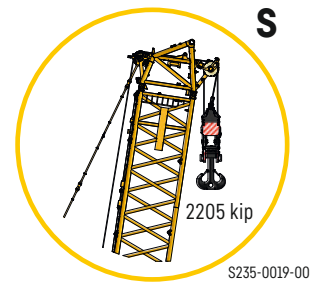
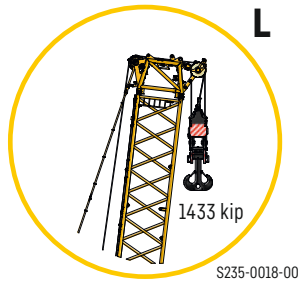
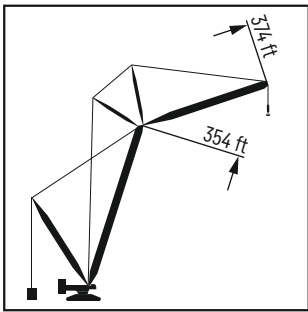

SDWB/BV/BW
S 138 ft - 354 ft
W 59 ft - 374 ft
D 118 ft - 138 ft

SDWVB/BV/BW
S 138 ft - 354 ft
W 59 ft - 79 ft
D 118 ft - 138 ft

SL2DB/BV/BW
SL2 138 ft - 512 ft
D 118 ft - 138 ft

S2DB/BW
S2 138 ft - 512 ft
D 118 ft - 138 ft

Extended boom system

Systèmes de flèche étendus

354 + 374

S 19.85 kip - 37.5 kip

L 15.5 kip - 19.85 kip

S + L 32.25 kip - 57.3 kip

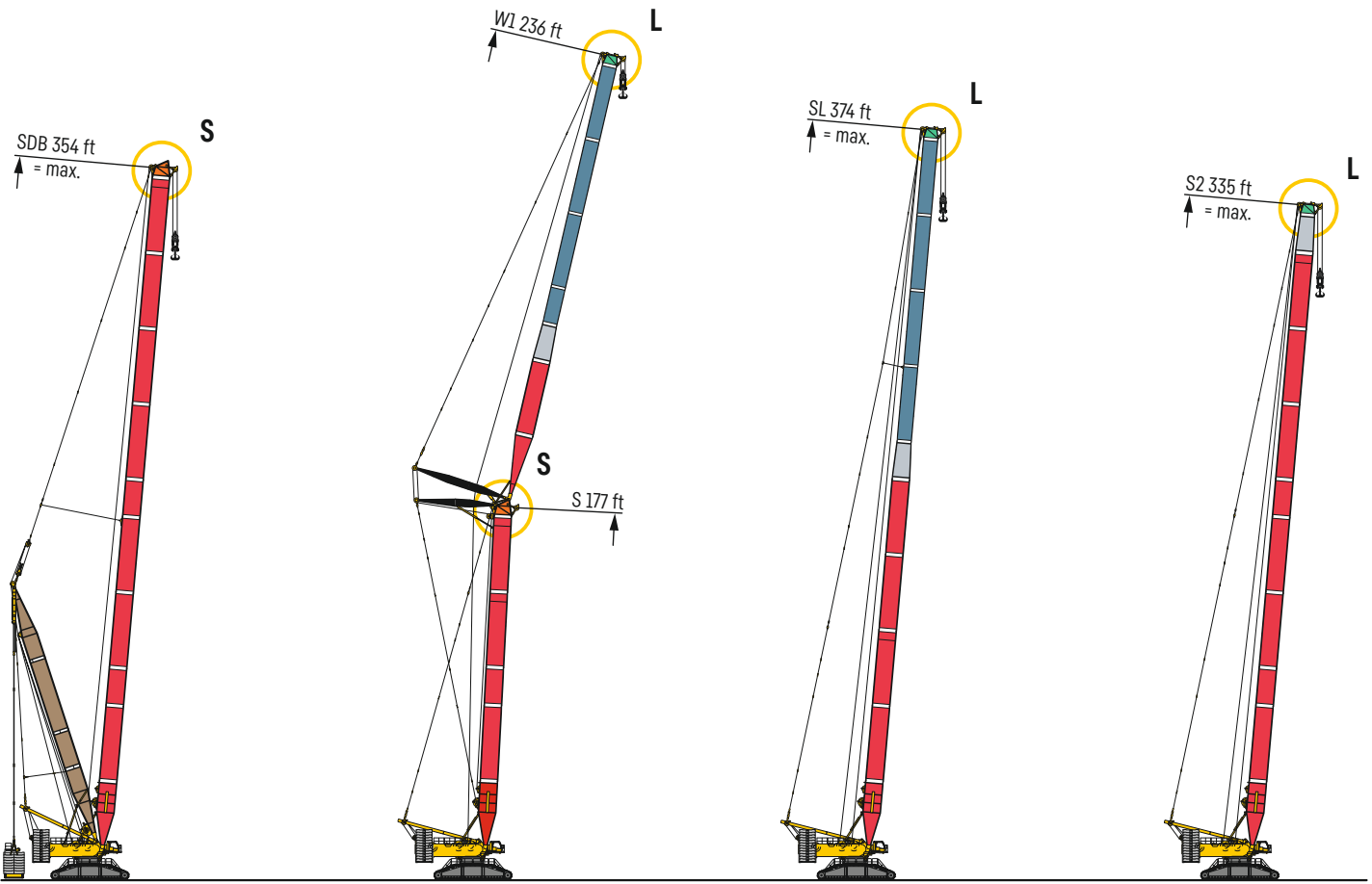
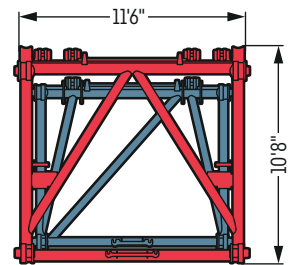
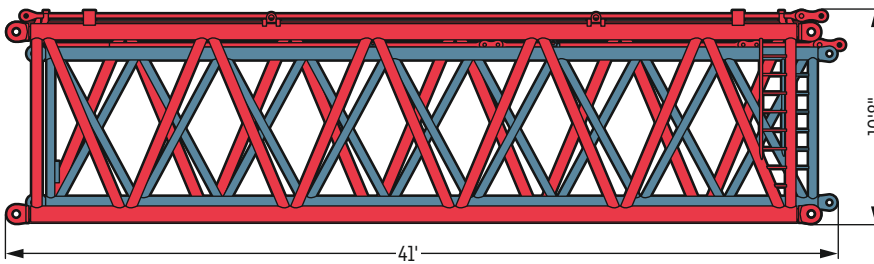

SDB/BV/BW

S 138 ft - 354 ft
D 118 ft - 138 ft

SW1

S 138 ft - 197 ft
W1 59 ft - 276 ft

SL

SL 59 ft - 374 ft

S2

S2 59 ft - 335 ft

US2800.01

PowerBoom system

Systèmes de flèche PowerBoom

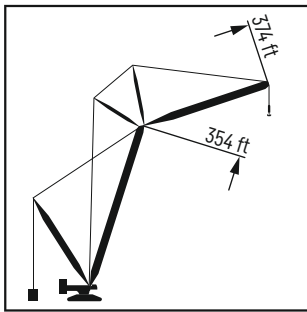

+

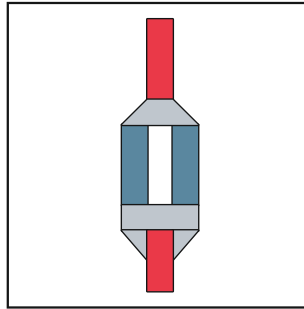

=

P PowerBoom

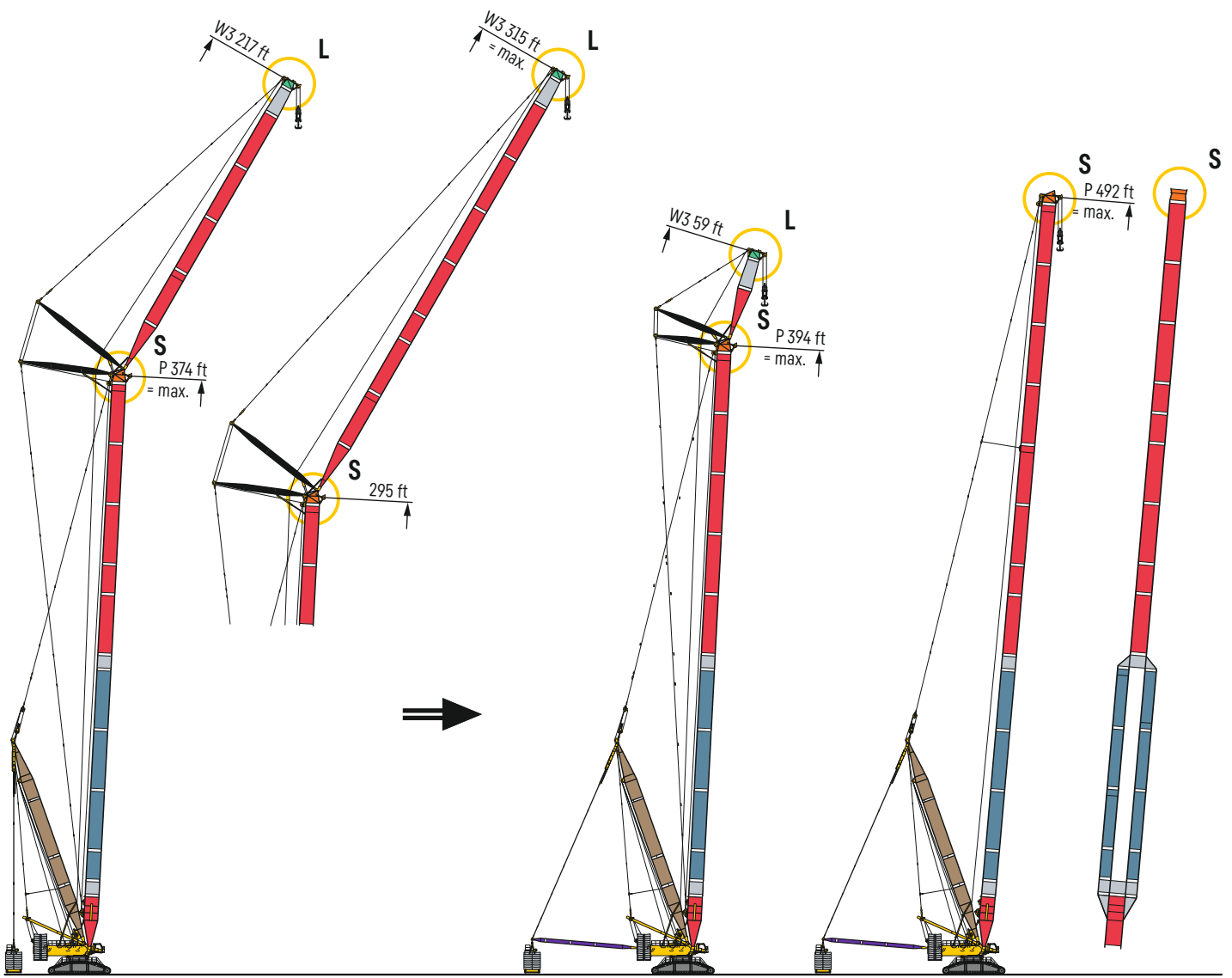

PDW3B/BW

P 157 ft - 394 ft
W3 59 ft - 315 ft
D 118 ft - 138 ft

PDWV3B/BW

P 157 ft - 394 ft
W3 59 ft - 79 ft
D 118 ft - 138 ft

PDB/BW

P 157 ft - 492 ft
D 118 ft - 138 ft

US2801.01

PowerBoom system

Systèmes de flèche PowerBoom

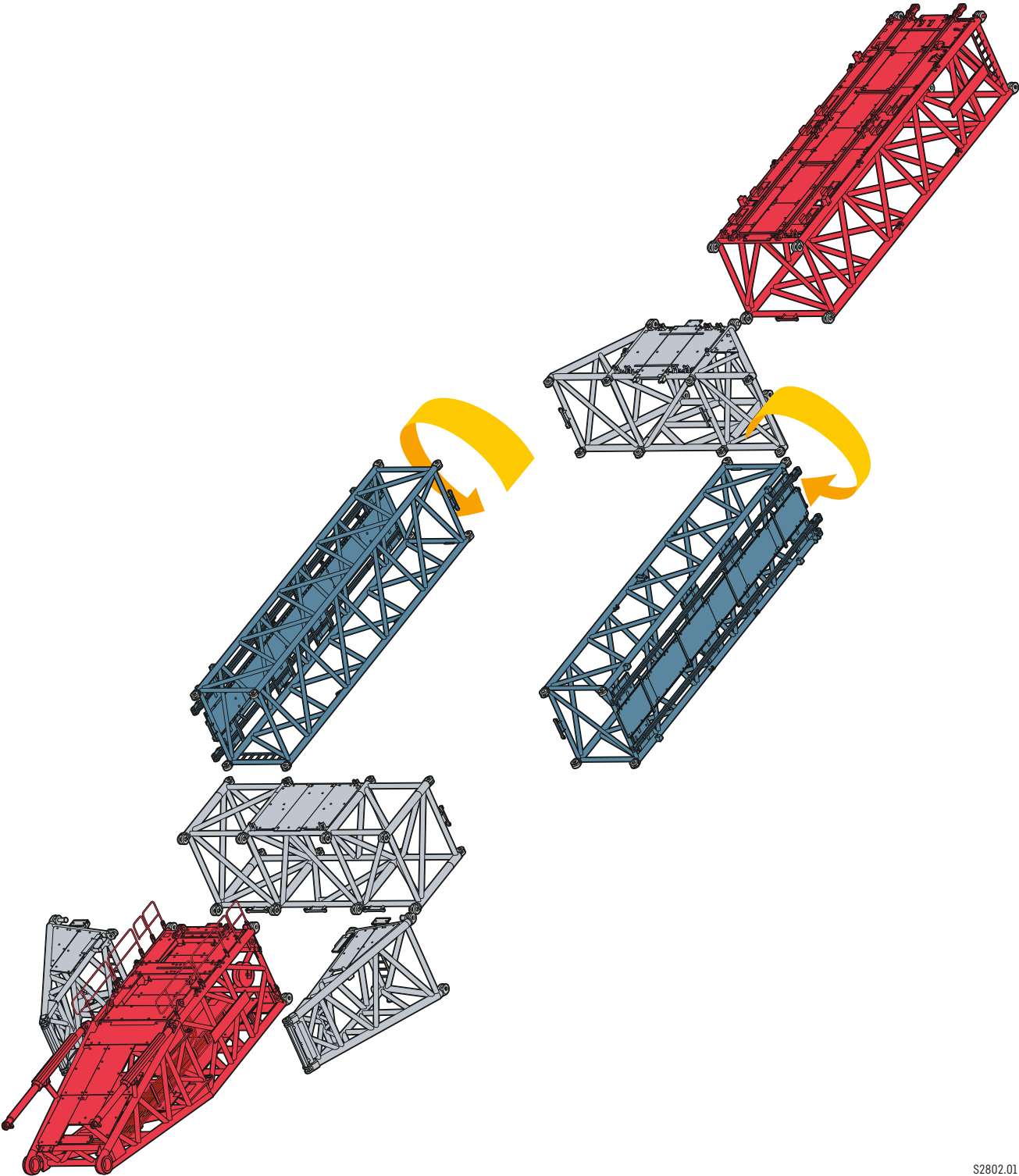

S2802.01

Boom system – Wind power

Systèmes de flèche – L'énergie éolienne

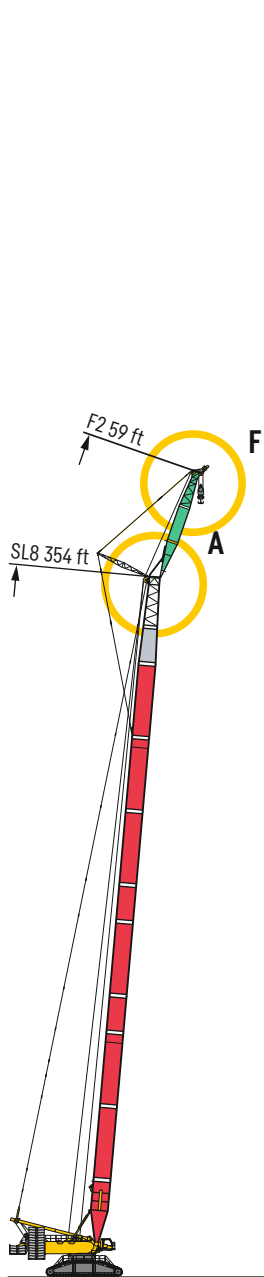
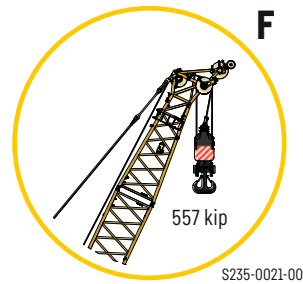
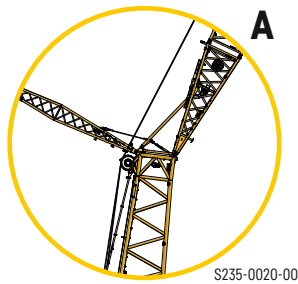
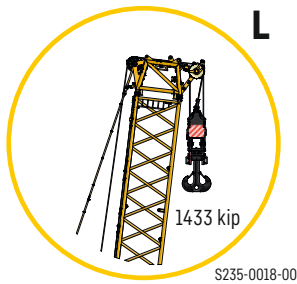

SL8F2

SL8 276 ft - 354 ft
F2 39 ft - 118 ft

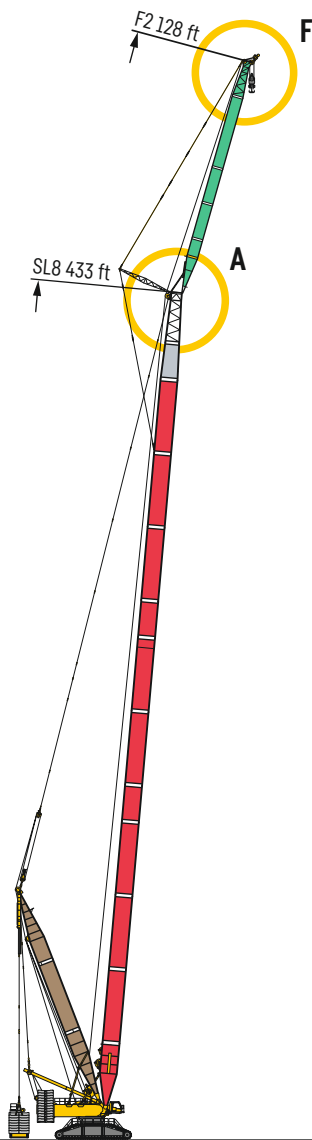

SL8DF2B

SL8 335 ft - 433 ft
F2 39 ft - 128 ft
D 118 ft

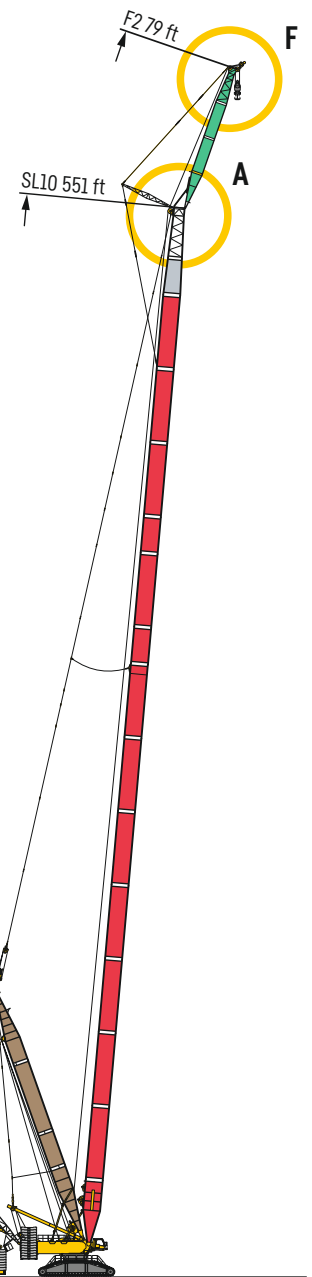

SL10DF2B/BV

SL10 236 ft - 551 ft
F2 39 ft - 128 ft
D 138 ft

Boom system – Wind power

Systèmes de flèche – L'énergie éolienne

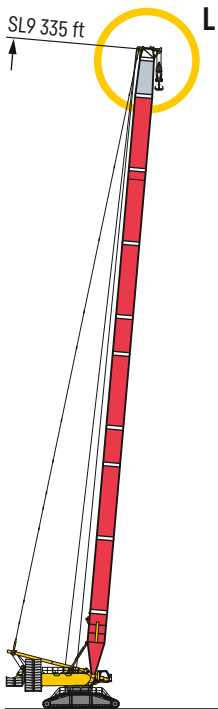

SL9
SL9 256 ft - 335 ft

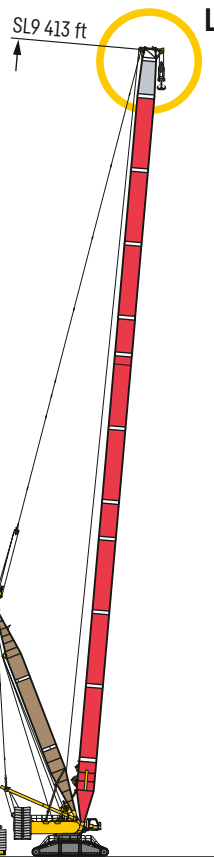

SL9DB
SL9 315 ft - 413 ft
D 118 ft

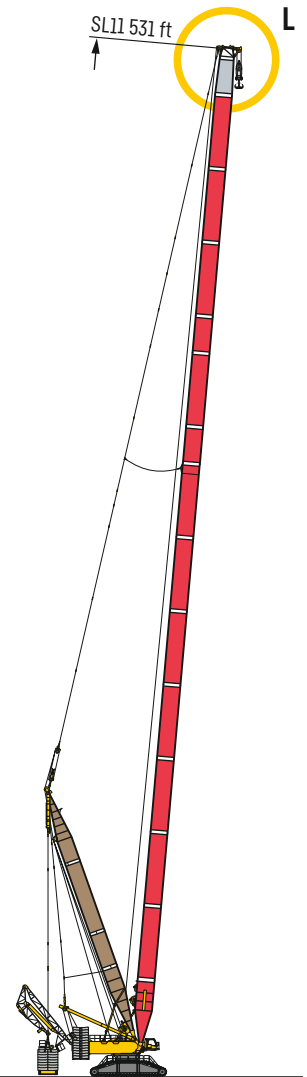

SL11DB/BV
SL11 217 ft - 531 ft
D 138 ft

US3414

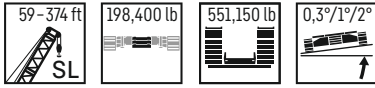

		SL 59 - 374 ft																
		59 ft	79 ft	98 ft	118 ft	138 ft	158 ft	177 ft	197 ft	217 ft	235 ft	256 ft	276 ft	295 ft	315 ft	335 ft	354 ft	374 ft
18	0.3	1432																
	1																	
	2																	
19	0.3	1432	1432															
	1																	
	2																	
20	0.3	1432	1432															
	1																	
	2																	
22	0.3	1432	1432	1431														
	1	1432	1432															
	2	1275																
24	0.3	1432	1432	1432	1425													
	1	1430	1432															
	2	1314																
26	0.3	1432	1432	1432	1430	1404												
	1	1406	1384															
	2	1322	1281															
28	0.3	1412	1421	1411	1395	1391	1351	907										
	1	1356	1325	1288	1259													
	2	1279	1210	1100														
30	0.3	1369	1357	1346	1345	1343	1273	1203	956									
	1	1289	1255	1223	1190	1100												
	2	1208	1147	1070														
32	0.3	1287	1282	1280	1279	1243	1176	1115	1059	844								
	1	1216	1185	1160	1108	1027	956											
	2	1145	1088	1033	951													
34	0.3	1213	1210	1212	1207	1152	1094	1038	989	943	619							
	1	1150	1123	1102	1035	963	899											
	2	1088	1038	979	896	822												
36	0.3	1145	1141	1143	1132	1074	1022	973	927	885	849	474						
	1	1090	1065	1040	971	906	848											
	2	1036	981	922	847	779												
38	0.3	1084	1082	1085	1056	1005	958	913	873	834	800	767	385					
	1	1035	1013	977	914	856	802	753	709									
	2	960	911	866	802	741	685											
40	0.3	1030	1028	1030	990	944	900	859	821	787	758	725	699					
	1	971	950	919	863	810	760	714	673	636								
	2	891	847	809	762	705	653	313										
50	0.3	734	741	747	745	718	689	661	635	610	590	568	548	532	515	503	484	446
	1	691	680	671	655	634	600	567	537	509	487	462	441					
	2	652	626	605	582	558	528	493	462	432	384							
60	0.3		559	565	565	563	552	531	511	492	477	460	445	433	420	411	397	388
	1		524	520	510	500	487	465	442	420	403	383	366	353				
	2		492	480	463	446	429	411	387	363	344	318	255	196				
70	0.3		444	451	451	448	445	439	423	407	395	381	369	360	349	343	331	324
	1		423	421	414	406	396	385	372	353	339	322	309	298				
	2		403	395	382	368	355	341	328	309	294	276	254	196				
80	0.3			371	371	368	365	361	357	343	334	321	311	304	295	291	280	275
	1			352	346	338	330	322	314	302	290	275	264	255				
	2			334	323	312	300	288	277	266	254	238	225	196				
90	0.3			313	313	311	307	302	299	294	286	274	266	260	252	249	239	235
	1			295	288	281	273	267	260	251	243	238	227	220				
	2			279	269	258	247	238	229	222	207	196	187	182				
100	0.3				269	266	262	258	254	250	247	237	229	224	217	215	206	202
	1				257	250	243	235	229	222	219	207	197	191				
	2				245	235	225	215	207	198	192	181	171	163				
110	0.3					232	227	223	219	215	214	206	199	194	188	186	178	175
	1					219	212	205	199	193	189	181	173	167				
	2					208	198	189	181	173	168	159	150	143				
120	0.3					204	199	194	191	186	185	180	174	169	163	162	155	152
	1					194	187	180	175	168	165	159	151	146				
	2					186	176	167	160	152	147	138	132	126				
130	0.3						176	171	168	163	162	157	152	148	142	142	135	132
	1						167	160	154	147	144	138	133	128				
	2						158	149	142	134	129	122	116	110				
140	0.3							157	152	148	143	141	136	133	130	124	117	115
	1							150	143	137	130	127	121	117	112			
	2							134	127	119	115	107	99.4	96				
150	0.3								136	132	126	124	119	116	109	109	102	99.9
	1								128	123	116	113	106	101				
	2								122	114	106	102	91.7	87				
160	0.3									122	118	112	110	105	95.1	94.9	88.6	86.7
	1									110	102	97.8	91.3	87.2				
	2									103	92	88.2	81.3	76.8				
170	0.3										105	97.5	94.4	89.4	86.8	85.7	83	82.8
	1										97.6	89.4	86.4	80.4	76.8	74.9	76.6	74.9
	2											82.9	79	72.1	67.8	65.2		
180	0.3											86.2	84.2	79.1	76.3	75.2	72.2	72
	1											80.4	77.3	71.3	67.6	65.9	66	64.3
	2											74.9	70.9	64.1	59.8	57		
190	0.3												77.4	75.2	69.9	67.1	62.6	62.4
	1													69.3	63.2	59.4	56.4	54.8
	2													63.9	56.7	51.7		
200	0.3																	
	1																	
	2																	
220	0.3																	
	1																	
	2																	
240	0.3																	
	1																	
	2																	
260	0.3																	
	1																	
	2																	

Lifting heights

Hauteurs de levage

SL

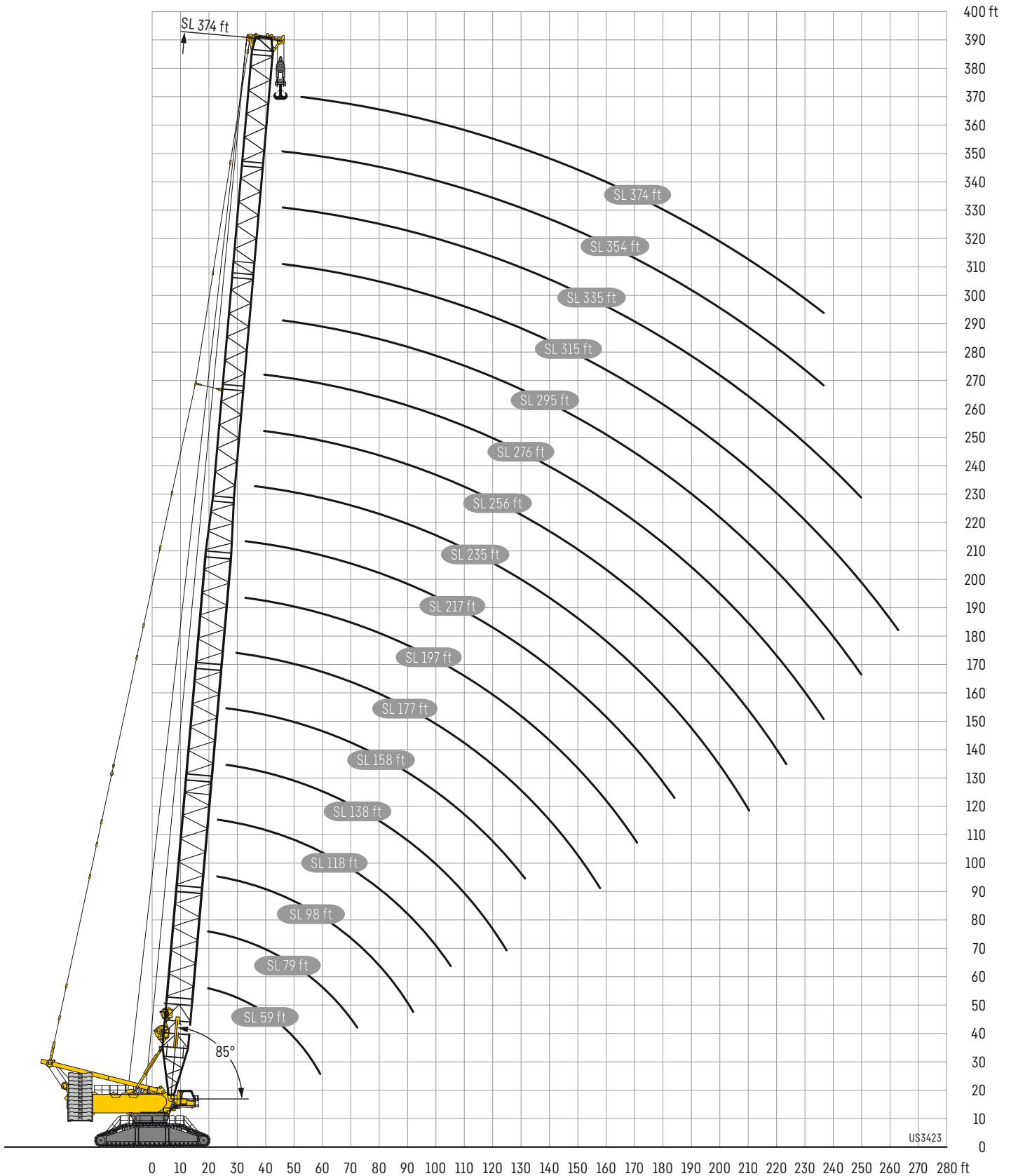

US3423



		S2 59 - 335 ft																
ft		59 ft	79 ft	98 ft	118 ft	138 ft	158 ft	177 ft	197 ft	217 ft	236 ft	256 ft	276 ft	295 ft	315 ft	335 ft	ft	
18		1432																18
19		1432	1432															19
20		1432	1432															20
22		1432	1432	1432														22
24		1432	1432	1432	1432													24
26		1432	1432	1432	1432	1411												26
28		1412	1421	1411	1391	1388	1364	1156										28
30		1369	1357	1342	1336	1334	1263	1195	1067									30
32		1287	1282	1273	1268	1235	1166	1107	1050	944								32
34		1213	1210	1204	1196	1143	1084	1030	979	935	842							34
36		1145	1141	1136	1122	1065	1012	965	917	876	838	664						36
38		1084	1082	1079	1048	996	947	904	862	825	788	753						38
40		1030	1028	1026	982	934	889	850	810	778	745	711	685					40
50		734	741	742	738	707	677	651	623	600	576	553	533	513	491	478		50
60			559	560	558	555	540	520	498	482	463	444	429	413	396	385		60
70			444	445	443	440	436	428	410	397	381	365	352	340	325	316		70
80				366	364	359	355	353	344	333	319	305	294	283	270	263		80
90				307	305	301	297	294	289	283	271	258	249	239	226	221		90
100					261	257	252	249	244	242	232	220	212	203	191	186		100
110						222	217	214	209	207	200	189	181	173	162	158		110
120						194	189	185	180	178	173	163	156	148	137	134		120
130							166	162	157	154	148	141	134	126	116	113		130
140							147	143	137	133	128	122	115	108	97.9	95.1		140
150								126	120	117	112	104	98.6	91.8	82.1	79.4		150
160								112	106	100	95.9	88.4	84.5	77.7	68.2	65.6		160
170									91	87.4	82.1	76.4	72	65.4	56	53.4		170
180											77.1	71.7	65.6	60.9	54.5	45.2		180
190											67.7	61.7	55.3	51	44.7	35.5		190
200												52.7	46.2	41.9	35.8	26.8		200
220													30.8	26.2	20.9			220

Lifting heights

Hauteurs de levage

S2

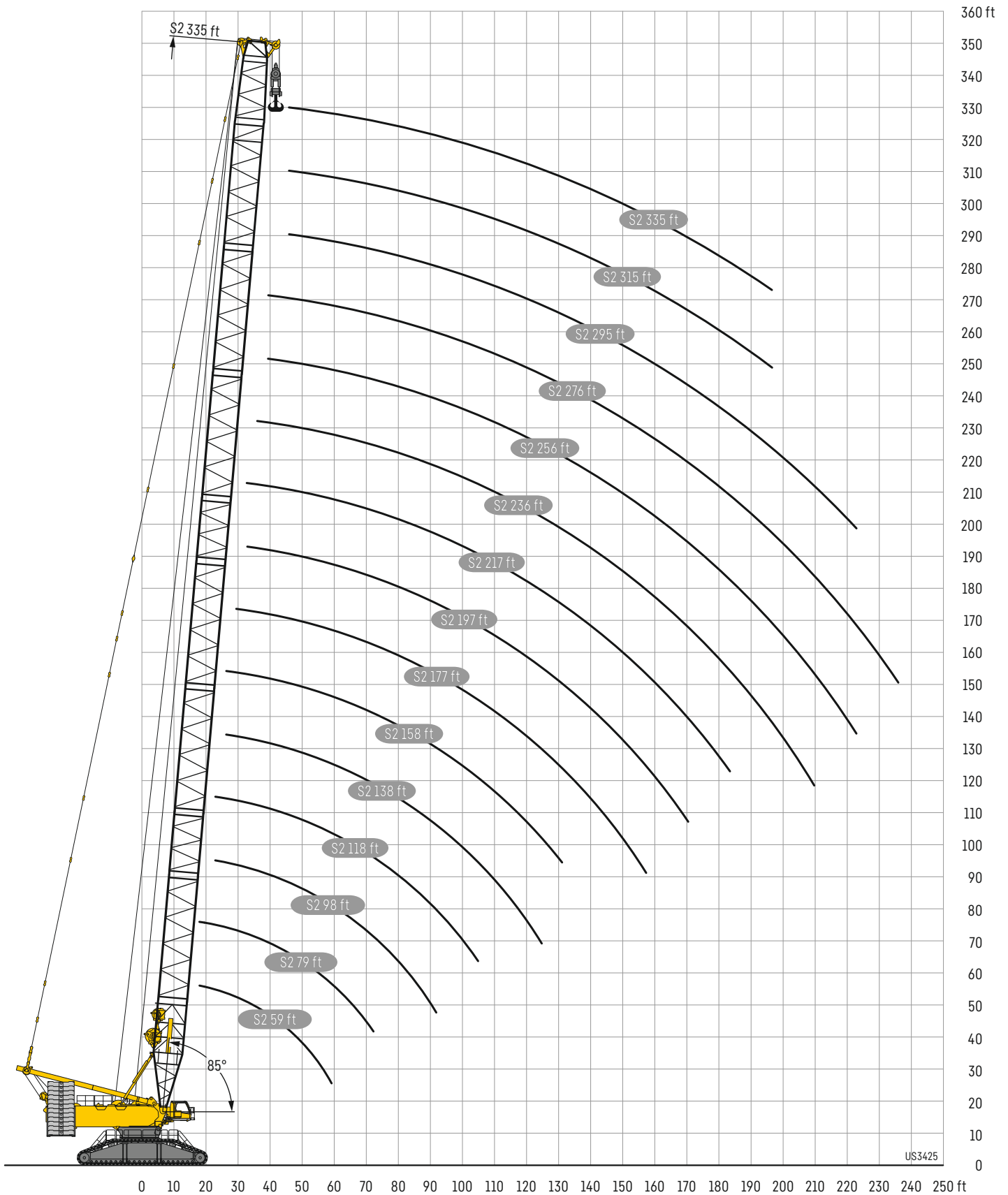

SDB/SDBV/SDBW

S 138 - 354



		S 138 - 354 ft											
		138 ft	158 ft	177 ft	197 ft	217 ft	236 ft	256 ft	276 ft	295 ft	315 ft	335 ft	354 ft
ft	S	D 118 ft					D 138 ft						
		28	B	2204									
	BV	2204											
	BW	2197	2202										
30	B	2204	2204										
	BV	2146	2159	2089									
	BW	2204	2204	2185									
32	B	2114	2098	2039	1959								
	BV	2204	2204	2149	2060								
	BW	2087	2044	1988	1916								
34	B	2204	2188	2114	2027								
	BV	2032	1990	1939	1874	1770							
	BW	2189	2142	2074	1995	1848							
36	B	1976	1936	1891	1832	1736	1587						
	BV	2147	2096	2032	1962	1838	1654						
	BW	1639	1642	1617	1602	1569	1497	1394	1257	1125	1008	901	
40	B	1913	1886	1839	1791	1718	1616	1461	1302	1153	1028		
	BV	1336	1371	1356	1351	1398	1355	1300	1229	1110	998	891	805
	BW	1653	1648	1638	1606	1551	1487	1412	1307	1158	1033	917	819
50	B	1097	1150	1159	1153	1207	1195	1174	1139	1071	976	881	796
	BV	1398	1420	1406	1398	1415	1370	1316	1255	1161	1037	920	820
	BW	919	959	999	1002	1051	1045	1029	1021	1000	946	858	772
60	B	1169	1233	1226	1220	1234	1242	1222	1177	1121	1038	919	812
	BV	781	815	852	875	931	922	914	907	893	873	821	750
	BW	994	1064	1084	1078	1138	1108	1092	1091	1058	1008	907	796
70	B	663	711	732	761	828	824	816	810	803	793	763	713
	BV	845	918	956	964	1052	1029	1005	980	969	951	887	771
	BW	575	612	649	673	745	740	733	730	723	715	701	671
80	B	728	795	836	868	972	955	936	918	894	867	839	746
	BV	501	545	574	592	671	670	664	660	656	650	640	626
	BW	635	698	739	771	887	880	870	858	839	817	786	730
90	B		477	507	527	607	610	605	601	597	593	585	578
	BV		610	656	687	814	806	800	796	783	768	744	700
	BW		414	446	467	548	552	553	549	546	542	535	530
100	B		540	588	617	749	743	735	733	726	718	700	665
	BV			397	416	743	741	733	731	724	718	709	692
	BW			525	559	492	500	497	499	502	498	491	486
110	B			352	379	687	687	681	676	671	666	655	631
	BV			466	498	677	683	677	674	669	664	655	646
	BW					443	453	454	459	462	459	452	448
120	B				334	623	634	631	629	622	618	609	597
	BV					613	628	626	623	620	616	607	597
	BW					405	417	418	421	428	424	417	415
130	B				443	566	582	584	585	579	574	567	560
	BV					557	574	575	579	574	573	563	557
	BW					369	381	381	382	394	390	386	384
140	B					516	535	544	543	540	535	528	523
	BV					509	527	532	538	534	532	524	519
	BW					331	344	345	351	361	360	359	356
150	B					470	493	506	507	503	500	492	487
	BV					466	487	491	498	499	496	490	484
	BW												
160	B												
	BV												
	BW												
170	B												
	BV												
	BW												
180	B												
	BV												
	BW												
190	B												
	BV												
	BW												
200	B												
	BV												
	BW												
220	B												
	BV												
	BW												
240	B												
	BV												
	BW												
260	B												
	BV												
	BW												
280	B												
	BV												
	BW												
300	B												
	BV												
	BW												

Lifting heights

Hauteurs de levage

SDB/SDBV/SDBW

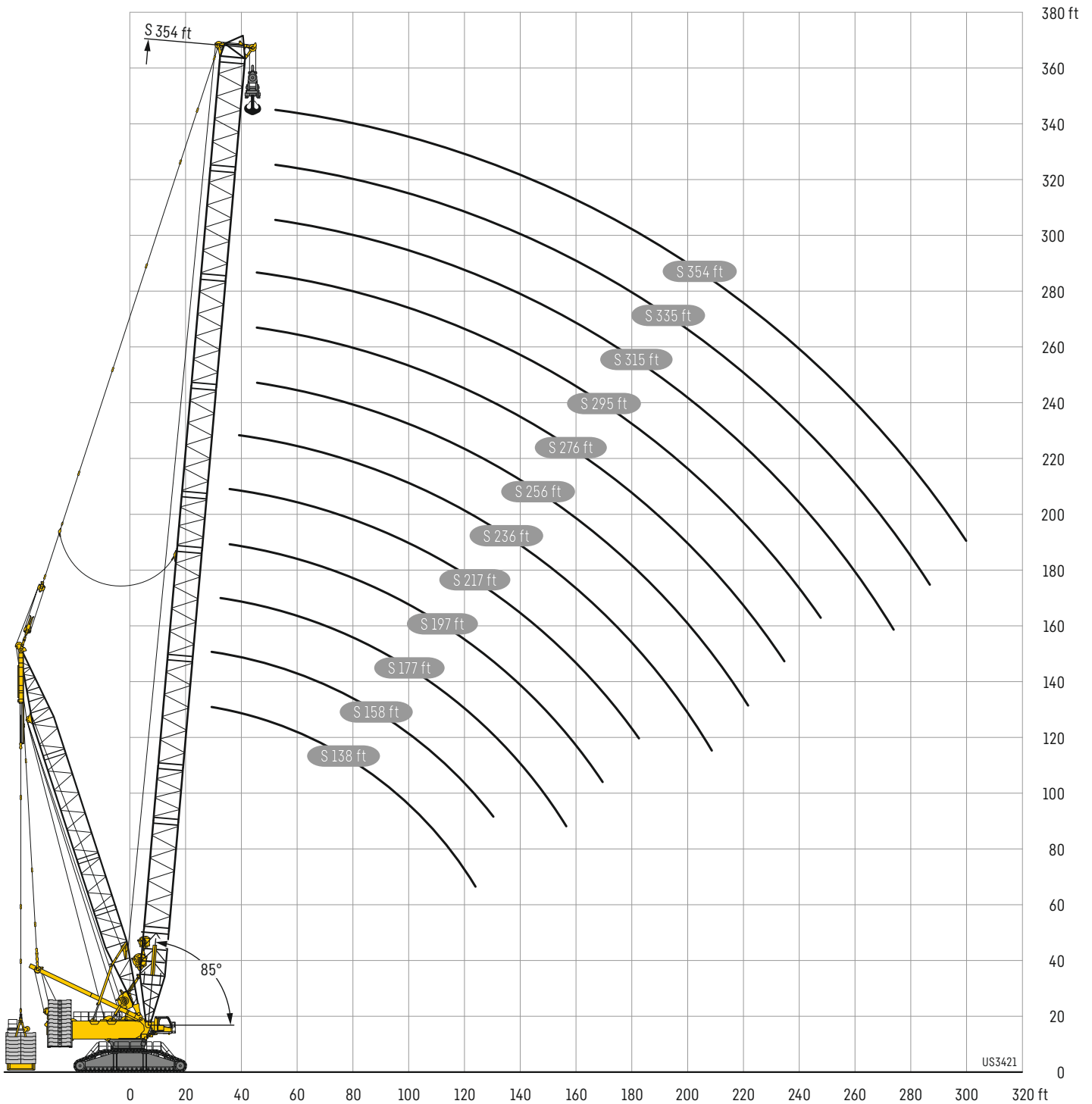

SL2DB/SL2DBV/SL2DBW

SL2 138 - 512



		SL2 138 - 512 ft																												
ft	ft	138 ft	158 ft	177 ft	197 ft	217 ft	236 ft	256 ft	276 ft	295 ft	315 ft	335 ft	354 ft	374 ft	394 ft	413 ft	433 ft	453 ft	472 ft	492 ft	512 ft									
		D 118 ft					D 138 ft																							
28	B	1380																												
	BV																													
	BW	1381																												
30	B	1385	1370																											
	BV																													
	BW	1386	1369																											
32	B	1390	1377	1368																										
	BV																													
	BW	1391	1374	1369																										
34	B	1395	1378	1372	1325																									
	BV																													
	BW	1396	1379	1372	1326																									
36	B	1400	1382	1374	1329	1281																								
	BV																													
	BW	1401	1386	1375	1331	1290																								
38	B	1404	1387	1373	1333	1286	1237																							
	BV																													
	BW	1407	1394	1375	1337	1293	1245																							
40	B	1407	1392	1381	1336	1291	1240	1187																						
	BV																													
	BW	1413	1392	1381	1337	1297	1249	1194																						
50	B	1432	1423	1406	1326	1291	1255	1198	1133	1068	977	879	792																	
	BV						1270	1217	1152	1071	979																			
	BW	1432	1423	1412	1366	1314	1268	1215	1154	1070	979	885	799																	
60	B	1323	1367	1356	1317	1289	1241	1190	1133	1064	972	875	790	703	614	535	499	437												
	BV					1342	1293	1237	1172	1071	979	885	802	711	617															
	BW	1432	1432	1423	1395	1337	1291	1236	1172	1071	979	885	802	711	617	514	495													
70	B	1100	1162	1182	1175	1224	1195	1173	1119	1049	957	866	786	700	607	533	498	436	381	336	294									
	BV					1337	1319	1260	1191	1071	979	885	804	713	618	514	493	413	368	328										
	BW	1390	1399	1369	1369	1335	1317	1245	1188	1071	979	885	804	713	617	514	493	414	369	328	272									
80	B	911	972	1010	1025	1075	1068	1050	1035	1014	946	854	776	685	597	531	494	432	377	333	292									
	BV					1259	1258	1236	1187	1071	978	885	786	714	620	516	492	411	366	325	268									
	BW	1168	1250	1254	1243	1284	1259	1222	1185	1070	977	885	804	711	617	514	491	410	367	326	269									
90	B	776	824	869	886	956	946	933	925	909	884	814	760	669	584	520	485	424	373	326	286									
	BV					1164	1134	1106	1099	1063	959	885	777	707	612	517	488	407	364	324	265									
	BW	996	1071	1110	1101	1193	1167	1138	1123	1058	972	885	801	705	610	514	488	407	365	325	267									
100	B	668	724	755	779	852	846	836	827	819	809	771	722	638	566	508	479	417	367	320	280									
	BV					1077	1052	1024	995	977	921	883	767	692	599	518	483	404	362	322	264									
	BW	848	929	976	988	1098	1081	1060	1029	997	952	880	793	691	598	514	483	403	363	322	265									
110	B	582	632	662	686	768	763	755	749	741	733	715	682	620	551	494	465	408	360	311	274									
	BV					997	979	956	932	907	879	849	758	676	584	518	478	401	361	320	263									
	BW	734	806	858	891	998	988	978	960	935	905	859	780	675	585	512	478	399	361	319	265									
120	B	508	557	585	603	683	694	686	680	674	668	659	643	589	526	481	450	400	352	306	271									
	BV					911	904	890	874	853	831	805	747	653	567	508	473	398	360	313	262									
	BW	631	704	751	794	908	903	893	884	873	853	826	769	651	565	508	473	398	359	315	264									
130	B		487	519	537	619	634	626	621	615	610	605	595	564	494	460	439	392	344	301	267									
	BV					838	830	822	813	801	783	764	717	629	542	490	467	397	358	306	262									
	BW		613	674	710	834	827	820	812	804	796	779	743	627	542	489	465	397	356	308	264									
140	B		424	458	478	561	569	574	569	565	560	554	549	532	472	439	426	380	335	295	261									
	BV					767	767	757	751	745	736	721	683	611	522	469	456	396	349	299	262									
	BW		546	602	637	758	764	755	748	743	734	727	707	608	521	470	455	395	349	300	263									
150	B			410	427	506	519	527	524	520	517	510	505	499	452	413	410	369	323	286	253									
	BV					700	710	703	695	690	685	676	650	594	506	454	445	393	338	289	261									
	BW			535	570	689	702	700	692	687	682	674	663	590	505	454	444	393	338	290	260									

SL2DB/SL2DBV/SL2DBW

SL2 138 - 512



		SL2 138 - 512 ft																			
		138 ft	158 ft	177 ft	197 ft	217 ft	236 ft	256 ft	276 ft	295 ft	315 ft	335 ft	354 ft	374 ft	394 ft	413 ft	433 ft	453 ft	472 ft	492 ft	512 ft
ft	B BV BW	D 118 ft				D 138 ft															
		160			372	391	455	476	482	483	481	477	472	466	463	437	398	391	356	312	275
	BV					636	654	653	647	641	637	630	616	577	490	441	436	387	326	278	254
	BW			476	512	626	642	648	643	638	633	628	617	573	489	440	435	387	327	280	253
170	B				346	419	435	439	446	447	443	438	433	430	421	382	375	344	301	264	241
	BV					576	598	606	603	597	593	588	579	557	475	427	426	379	318	268	245
	BW				467	570	588	598	598	593	588	585	575	552	474	427	425	378	318	270	246
180	B					382	394	400	413	413	409	407	402	400	397	372	358	334	291	249	234
	BV					526	550	564	560	558	554	549	543	533	460	414	417	371	310	261	239
	BW					521	540	556	555	553	550	544	536	526	458	413	415	370	310	262	240
190	B					344	357	365	379	379	379	378	374	372	370	355	341	321	280	242	223
	BV					480	508	522	523	521	518	513	507	505	445	401	407	363	302	253	233
	BW					477	500	514	517	517	514	509	502	498	443	400	405	362	302	254	234
200	B						331	339	346	350	354	352	349	347	346	335	324	306	273	235	217
	BV						462	480	487	487	485	480	475	473	432	389	398	355	294	246	227
	BW						457	472	481	484	482	476	471	467	429	387	396	354	294	246	228
220	B							292	299	302	303	307	302	303	299	290	286	271	254	218	204
	BV							413	424	428	428	424	420	417	407	365	381	339	279	231	215
	BW							404	418	424	421	420	416	414	403	364	378	337	279	232	217
240	B								248	254	259	259	260	262	262	258	252	244	236	202	189
	BV								360	369	378	376	372	370	372	344	358	325	264	217	203
	BW								355	363	370	372	369	368	367	342	354	322	264	219	204
260	B								222	227	228	229	231	233	231	221	219	214	190	178	
	BV								324	333	335	331	331	331	322	327	309	251	205	193	
	BW								318	327	330	328	328	328	319	321	307	250	207	193	
280	B											199	201	200	206	202	189	191	191	176	167
	BV											287	290	295	297	296	292	284	239	194	182
	BW											283	285	292	292	292	287	281	238	194	184
300	B												167	167	176	171	168	166	166	159	155
	BV												258	262	266	266	263	259	228	185	173
	BW												253	258	260	262	260	255	227	185	174
320	B													146	151	150	150	147	147	143	140
	BV													233	238	240	237	233	218	176	165
	BW													229	233	236	235	231	217	177	167
340	B														132	133	133	132	131	129	126
	BV														212	215	213	207	208	168	158
	BW														209	210	211	204	208	170	159
360	B															118	118	117	117	115	113
	BV															186	183	182	185	162	152
	BW															182	180	178	182	163	152
380	B																	101	103	101	101
	BV																	163	165	156	147
	BW																	161	161	158	146
400	B																		89.4	89.1	88.4
	BV																		148	141	141
	BW																		144	141	141
420	B																			78.3	78
	BV																			121	131
	BW																			122	129
440	B																				68.1
	BV																				118
	BW																				117

Lifting heights

Hauteurs de levage

SL2DB/SL2DBV/SL2DBW

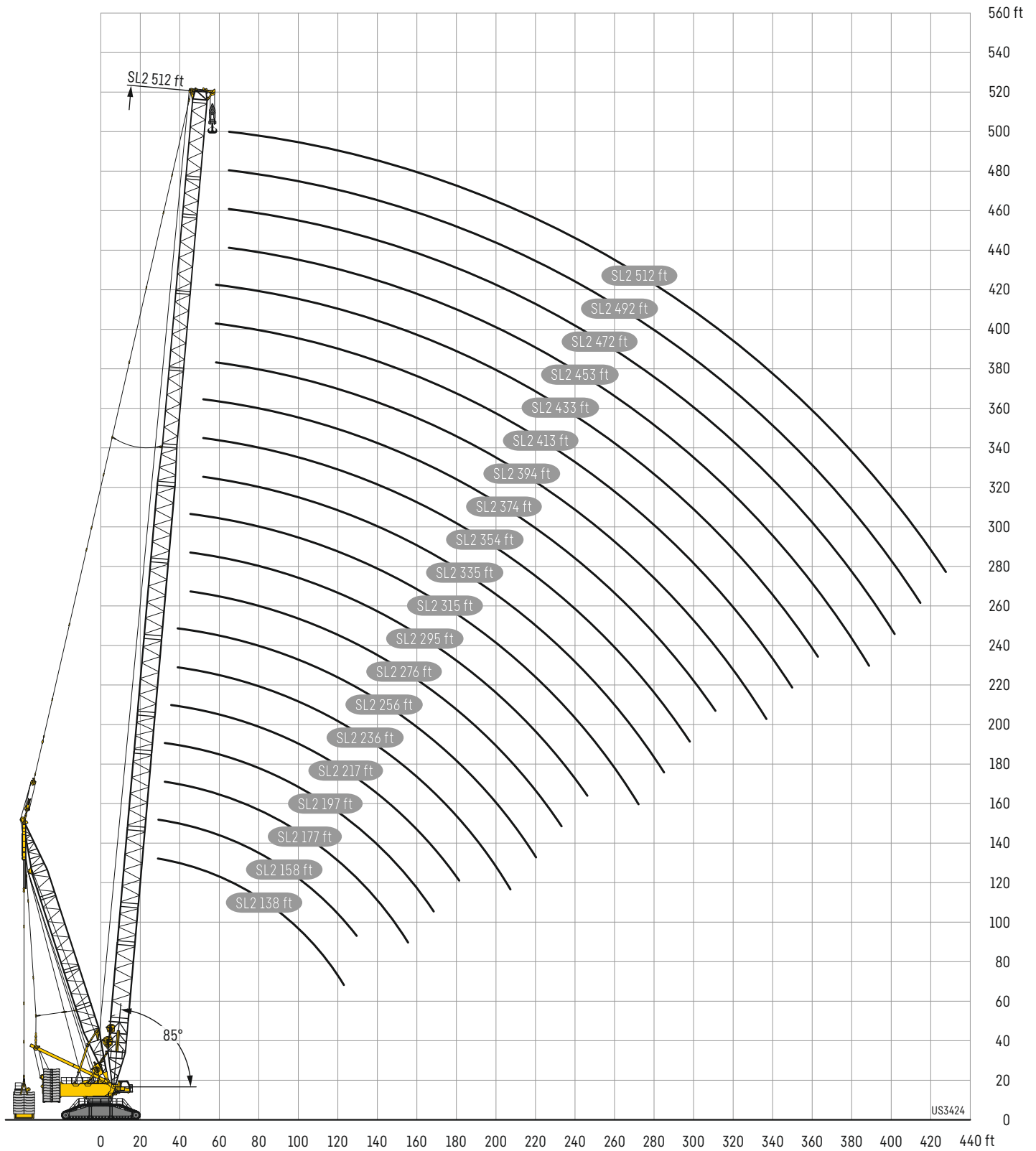

S2DB/S2DBW

S2 138 - 512



		S2 138 - 512 ft																				
ft	B BW	138 ft	158 ft	177 ft	197 ft	217 ft	236 ft	256 ft	276 ft	295 ft	315 ft	335 ft	354 ft	374 ft	394 ft	413 ft	433 ft	453 ft	472 ft	492 ft	512 ft	
		D 118 ft					D 138 ft															
28	B	1432																				
	BW	1432																				
30	B	1432	1432																			
	BW	1432	1432																			
32	B	1432	1432	1432																		
	BW	1432	1432	1432																		
34	B	1432	1432	1432	1432																	
	BW	1432	1432	1432	1432																	
36	B	1428	1432	1432	1432	1432																
	BW	1432	1432	1432	1432	1432																
38	B	1428	1432	1432	1432	1432	1432															
	BW	1432	1432	1432	1432	1432	1432															
40	B	1428	1427	1432	1432	1432	1432	1427														
	BW	1432	1432	1432	1432	1432	1432	1432														
50	B	1428	1427	1421	1415	1420	1425	1402	1265	1137	1018	911	815									
	BW	1432	1432	1432	1432	1432	1432	1431	1314	1162	1039	925	823									
60	B	1321	1365	1371	1339	1393	1353	1306	1242	1123	1004	902	811	725	650	574	502	450				
	BW	1432	1432	1432	1432	1432	1432	1410	1307	1162	1043	929	827	736	656	582	502					
70	B	1093	1149	1175	1166	1216	1203	1182	1147	1082	984	889	804	714	641	573	502	451	405	361	320	
	BW	1389	1402	1391	1373	1406	1392	1351	1275	1153	1044	931	825	728	660	581	502	448	410	360	318	
80	B	906	960	1004	1014	1062	1053	1038	1026	1007	951	868	782	702	635	571	502	448	401	357	316	
	BW	1165	1239	1243	1233	1281	1279	1259	1210	1141	1038	926	814	713	660	579	502	443	409	357	314	
90	B	769	816	853	878	942	932	920	913	900	877	827	761	690	623	557	496	442	397	354	311	
	BW	991	1064	1099	1091	1188	1162	1134	1119	1089	1022	913	800	695	657	575	502	438	407	353	309	
100	B	662	715	747	762	839	832	823	815	810	798	769	720	662	606	550	491	438	390	348	307	
	BW	842	922	957	976	1083	1073	1050	1022	1002	973	889	785	674	652	569	502	434	405	350	305	
110	B	575	615	653	676	756	748	741	736	731	720	708	677	629	581	530	479	431	386	344	304	
	BW	727	797	849	874	984	974	965	949	929	902	856	772	654	646	563	500	429	402	348	300	
120	B	504	549	577	595	675	680	672	666	663	656	648	634	596	557	513	466	420	377	339	300	
	BW	625	697	743	782	896	889	878	872	862	844	817	761	653	635	558	498	426	397	345	296	
130	B		480	510	529	613	619	613	607	603	598	593	586	563	533	491	451	412	370	333	294	
	BW		609	658	701	821	813	805	799	792	784	769	735	652	619	554	493	422	391	343	293	
140	B		416	450	470	553	557	560	556	553	546	542	538	525	505	470	435	398	360	329	291	
	BW		541	592	627	749	749	739	735	731	722	717	699	646	602	552	487	422	383	341	290	
150	B			402	419	497	505	516	511	509	503	498	495	487	472	445	418	383	350	320	286	
	BW			527	562	681	690	685	679	676	669	662	655	624	587	538	479	422	373	338	288	
160	B			355	381	446	458	473	470	470	464	461	456	452	440	422	395	367	339	311	278	
	BW			467	501	618	633	635	629	627	621	615	607	593	568	522	470	422	364	334	288	
170	B				337	410	421	430	430	436	429	426	422	419	408	397	374	350	327	300	272	
	BW				446	562	579	587	584	582	577	571	565	557	543	504	459	415	356	329	288	
180	B					373	385	391	392	402	397	395	391	389	381	371	354	333	313	288	262	
	BW					514	531	545	542	542	537	532	526	520	512	486	447	406	348	324	288	
190	B					336	348	354	361	370	369	368	364	361	356	349	334	318	299	275	252	
	BW					469	491	504	505	506	501	497	492	485	480	464	434	394	341	318	285	
200	B						322	330	336	342	345	341	339	336	332	326	311	301	283	263	242	
	BW						448	462	470	473	469	465	461	454	450	441	419	381	333	313	280	
220	B							282	290	294	293	289	294	287	287	279	272	265	254	240	223	
	BW							396	406	414	411	408	406	402	397	390	383	357	319	299	272	
240	B								239	246	250	252	254	253	252	246	243	236	229	216	197	
	BW								344	356	361	362	360	356	345	348	344	331	304	284	258	
260	B									213	217	222	220	224	220	219	212	210	200	186	175	
	BW									310	318	323	319	316	293	311	308	297	285	267	244	
280	B												183	180	193	183	190	179	181	171	166	157
	BW												278	278	281	251	278	276	268	254	247	229
300	B													159	160	158	160	157	156	151	149	140
	BW													245	249	221	248	247	241	213	226	212
320	B														139	138	140	139	137	134	131	124
	BW														221	197	223	217	217	178	203	191
340	B															121	122	122	121	119	115	109
	BW															178	191	187	192	145	179	172
360	B																105	104	106	103	99.4	93.3
	BW																166	166	166	124	154	156
380	B																		90	89.1	85.6	79.1
	BW																		147	103	127	139
400	B																			76.8	73.1	66
	BW																			86.6	106	122
420	B																				61.9	54.9
	BW																				89.4	100
440	B																					45
	BW																					82.9

Lifting heights

Hauteurs de levage

S2DB/S2DBW

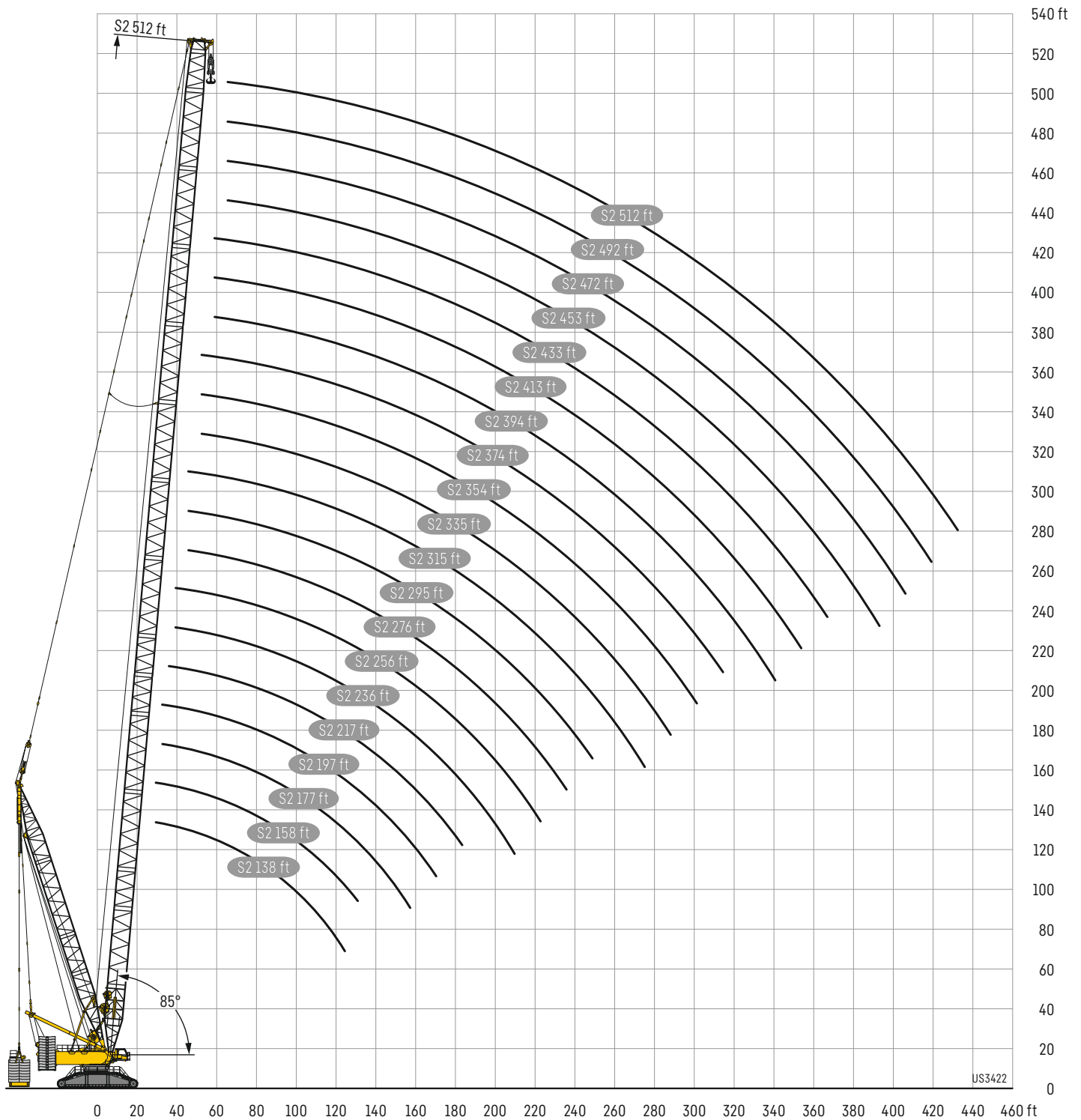



		P 158 - 492 ft																		
ft	ft	158 ft	177 ft	197 ft	217 ft	236 ft	256 ft	276 ft	295 ft	315 ft	335 ft	354 ft	374 ft	394 ft	413 ft	433 ft	453 ft	472 ft	492 ft	
		D 118 ft				D 138 ft														
30	B	2201																		
	BW	2204																		
32	B	2143	2087																	
	BW	2204	2203																	
34	B	2083	2034	1977																
	BW	2204	2166	2096																
36	B	2026	1980	1929																
	BW	2174	2118	2055																
38	B	1970	1928	1881	1744															
	BW	2123	2071	2014	1781															
40	B	1914	1879	1835	1735	1629														
	BW	2075	2026	1973	1785	1662														
50	B	1625	1600	1592	1578	1533	1478	1424	1323	1267	1189									
	BW	1863	1823	1785	1741	1654	1603	1538	1450	1345	1233									
60	B	1354	1341	1332	1386	1359	1326	1293	1227	1181	1134	1053	995	913	831	755				
	BW	1632	1623	1593	1588	1538	1487	1431	1378	1317	1229	1128	1032	940	851	741				
70	B	1130	1142	1135	1186	1182	1167	1145	1120	1089	1061	989	954	897	821	749	674			
	BW	1403	1389	1382	1446	1412	1371	1325	1285	1237	1181	1086	1000	925	849	723	694	621	551	
80	B	950	984	984	1029	1027	1016	1007	995	979	955	898	879	851	795	735	663			
	BW	1214	1211	1202	1266	1274	1267	1233	1197	1159	1106	1016	947	874	823	712	688	616	545	
90	B	804	842	865	911	902	897	887	876	871	852	824	803	774	734	701	647			
	BW	1042	1068	1059	1168	1143	1134	1129	1116	1077	1028	943	891	824	785	698	678	607	537	
100	B	699	722	754	807	804	797	786	781	773	754	742	729	710	682	650	605			
	BW	909	946	946	1054	1046	1031	1015	1010	994	952	880	839	777	742	677	658	596	527	
110	B	599	638	651	725	719	714	707	698	692	683	666	650	641	622	602	568			
	BW	786	827	849	953	945	938	927	916	910	886	822	788	734	701	652	636	587	520	
120	B	521	561	581	653	651	645	636	631	626	618	610	596	580	560	548	527			
	BW	689	728	759	864	860	852	843	836	830	820	773	742	695	662	622	605	571	511	
130	B	465	495	517	587	590	586	576	571	566	561	557	548	536	517	501	484			
	BW	601	645	676	790	783	778	769	763	757	751	724	700	663	633	594	572	548	503	
140	B	403	436	457	532	539	533	525	520	515	510	508	501	494	478	465	448			
	BW	533	569	606	721	721	713	706	699	693	687	674	655	629	606	569	546	525	495	
150	B		386	406	481	490	489	480	475	471	465	463	458	451	439	430	415			
	BW		507	546	658	666	659	649	641	639	631	623	610	592	572	545	521	503	477	
160	B		341	369	432	442	451	442	435	432	427	424	419	412	403	396	385			
	BW		449	489	604	613	610	601	584	587	584	568	565	555	537	519	497	482	457	
170	B			324	395	399	416	409	402	398	392	390	385	378	369	364	355			
	BW			434	548	563	562	557	532	538	540	502	524	513	501	490	472	461	439	
180	B				359	362	379	377	372	367	361	359	354	348	339	334	327			
	BW				498	516	521	516	488	487	500	441	487	478	465	458	446	438	421	
190	B				321	333	342	349	344	339	334	331	326	320	313	307	301			
	BW				455	467	481	480	451	444	456	390	453	445	433	425	417	414	401	
200	B					307	316	323	316	311	309	307	301	295	288	284	277			
	BW					431	446	447	420	409	419	351	422	415	404	398	388	386	379	
220	B						257	263	261	265	267	265	259	252	244	242	237			
	BW						373	383	374	354	349	290	370	363	352	347	339	338	331	
240	B							224	224	229	231	226	223	218	209	206	201			
	BW							329	331	319	304	244	325	319	309	304	296	296	289	
260	B								192	191	189	186	191	187	179	176	171			
	BW								281	285	276	213	287	280	272	269	247	260	254	
280	B											157	162	162	161	153	149			
	BW											249	191	253	247	239	236	230	224	
300	B												139	140	139	128	123			
	BW												180	222	218	208	165	202	198	
320	B													121	120	110	108			
	BW													186	193	186	184	178	174	
340	B														103	93.3	90.6			
	BW														168	165	162	156	153	
360	B															78.9	75.6			
	BW															145	142	88	138	132
380	B																56.9			
	BW																73.2	121	108	
400	B																			
	BW																	106	88.7	
420	B																			
	BW																		72	

Lifting heights

Hauteurs de levage

PDB/PDBW

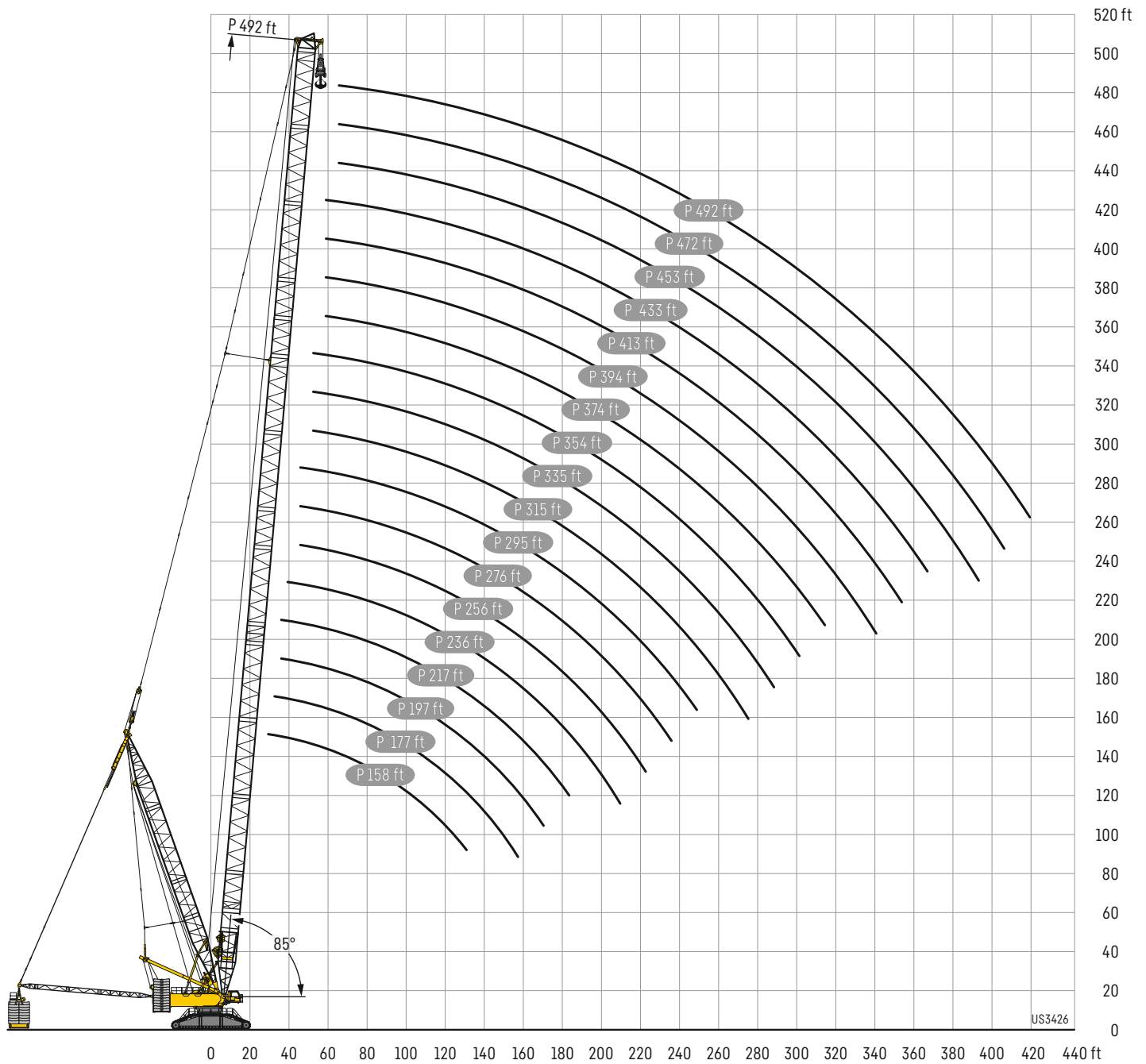



418,900 - 551,150 lb

ft	S 79 ft																						ft			
	W1 59 ft		W1 79 ft		W1 98 ft		W1 118 ft		W1 138 ft		W1 158 ft		W1 177 ft		W1 197 ft		W1 217 ft		W1 236 ft		W1 256 ft			W1 276 ft		
	87/85*	WVmax	87/85*	WVmax	87/85*	WVmax	87/85*	WVmax	87/85*	WVmax	87/85*	WVmax	87/85*	WVmax	87/85*	WVmax	87/85*	WVmax	87/85*	WVmax	87/85*	WVmax		87/85*	WVmax	
34	1130.0	1130.0																							34	
36	1059.0	1060.0 ⁽¹⁾																								36
38	997.0	997.0																								38
40	941.0	941.0	895.0	895.0																						40
50	733.0	733.0	702.0	702.0	670.0	670.0	643.0	643.0																		50
60	600.0	600.0	575.0	575.0	550.0	550.0	529.0	529.0	510.0	510.0	494.0	494.0														60
70	487.0	487.0	485.0	485.0	464.0	464.0	447.0	447.0	432.0	432.0	419.0	419.0	403.0	403.0	392.0	392.0										70
80	392.0 ⁽¹¹⁾	405.0	405.0	400.0	400.0	385.0	385.0	372.0	372.0	362.0	362.0	348.0	348.0	339.0	339.0	326.0	326.0	298.0	298.0							80
90	320.0 ⁽⁹⁾	344.0	344.0	341.0	341.0	337.0	337.0	325.0	325.0	316.0	316.0	304.0	304.0	297.0	297.0	285.0	285.0	278.0	278.0	267.0	267.0	210.0	210.0			90
100	266.0 ⁽⁹⁾	286.0 ⁽¹¹⁾	295.0	295.0	293.0	293.0	288.0	288.0	280.0	280.0	269.0	269.0	262.0	262.0	252.0	252.0	245.0	245.0	235.0	235.0	230.0	230.0				100
110	222.0 ⁽⁷⁾	240.0 ⁽¹⁰⁾	257.0	257.0	257.0	257.0	254.0	254.0	250.0	250.0	240.0	240.0	234.0	234.0	224.0	224.0	219.0	219.0	209.0	209.0	204.0	204.0				110
120		204.0 ⁽¹⁰⁾	217.0 ⁽¹¹⁾	227.0	227.0	225.0	225.0	224.0	224.0	215.0	215.0	210.0	210.0	201.0	201.0	196.0	196.0	187.0	187.0	182.0	182.0					120
130		172.0 ⁽⁸⁾	185.0 ⁽¹⁰⁾	202.0	202.0	200.0	200.0	200.0	200.0	195.0	195.0	189.0	189.0	181.0	181.0	176.0	176.0	168.0	168.0	163.0	163.0					130
140			158.0 ⁽¹⁰⁾	171.0 ⁽¹¹⁾	180.0	180.0	179.0	179.0	176.0	176.0	172.0	172.0	163.0	163.0	159.0	159.0	151.0	151.0	147.0	147.0						140
150				147.0 ⁽¹⁰⁾	162.0	162.0	162.0	162.0	158.0	158.0	157.0	157.0	148.0	148.0	144.0	144.0	140.0	140.0	137.0	137.0						150
160				126.0 ⁽¹⁰⁾	137.0 ⁽¹¹⁾	146.0	146.0	142.0	142.0	140.0	140.0	135.0	135.0	131.0	131.0	124.0	124.0	120.0	120.0							160
170				104.0 ⁽⁸⁾	116.0 ⁽¹⁰⁾	133.0	133.0	129.0	129.0	128.0	128.0	124.0	124.0	120.0	120.0	112.0	112.0	109.0	109.0							170
180				87.1 ⁽⁶⁾	97.8 ⁽⁸⁾	112.0 ⁽¹¹⁾	118.0	118.0	117.0	117.0	112.0	112.0	109.0	109.0	102.0	102.0	102.0	102.0	98.8	98.8						180
190					82.3 ⁽⁸⁾	96.2 ⁽¹¹⁾	109.0	109.0	107.0	107.0	101.0	101.0	101.0	101.0	99.2	99.2	93.0	93.0	89.8	89.8						190
200						80.4 ⁽¹¹⁾	94.6	94.6	89.0	89.0	86.4 ⁽¹¹⁾	94.6	90.5	90.5	89.0	89.0	84.9	84.9	81.6	81.6						200
220						52.5 ⁽⁷⁾			63.2 ⁽¹¹⁾	76.4	76.4	74.6	74.6	74.6	74.6	70.6	70.6	67.5	67.5							220
240									37.2 ⁽⁷⁾	48.6 ⁽¹¹⁾	55.5 ⁽¹¹⁾	63.0	63.0	63.0	63.0	58.9	58.9	55.9	55.9							240
260										26.7 ⁽⁷⁾	36.0 ⁽¹¹⁾	42.5 ⁽¹¹⁾	46.8	46.8	46.8	45.0	45.0	45.0	45.0							260
280											14.7 ⁽⁷⁾	25.6 ⁽¹¹⁾	29.9 ⁽¹¹⁾	37.3	37.3	37.3	37.3	37.3								280
300																										300

1) 12° 2) 17° 3) 22° 4) 27° 5) 32° 6) 37° 7) 42° 8) 47° 9) 52° 10) 57° 11) 62°



418,900 - 551,150 lb

ft	S 98 ft																						ft			
	W1 59 ft		W1 79 ft		W1 98 ft		W1 118 ft		W1 138 ft		W1 158 ft		W1 177 ft		W1 197 ft		W1 217 ft		W1 236 ft		W1 256 ft			W1 276 ft		
	87/85*	WVmax	87/85*	WVmax	87/85*	WVmax	87/85*	WVmax	87/85*	WVmax	87/85*	WVmax	87/85*	WVmax	87/85*	WVmax	87/85*	WVmax	87/85*	WVmax	87/85*	WVmax		87/85*	WVmax	
36	1000.0	1000.0																								36
38	943.0	943.0																								38
40	892.0	892.0	850.0	850.0																						40
50	700.0	700.0	671.0	671.0	641.0	641.0	615.0	615.0																		50
60	575.0	575.0	552.0	552.0	528.0	528.0	508.0	508.0	490.0	490.0	475.0	475.0														60
70	487.0	487.0	467.0	467.0	447.0	447.0	431.0	431.0	416.0	416.0	403.0	403.0	388.0	388.0	378.0	378.0										70
80	394.0 ⁽¹¹⁾	404.0	404.0	386.0	386.0	372.0	372.0	359.0	359.0	349.0	349.0	336.0	336.0	327.0	327.0	316.0	316.0	249.0	249.0							80
90	321.0 ⁽¹¹⁾	343.0	343.0	338.0	338.0	326.0	326.0	314.0	314.0	306.0	306.0	294.0	294.0	287.0	287.0	277.0	277.0	268.0	268.0	260.0	260.0					90
100	267.0 ⁽⁹⁾	287.0 ⁽¹¹⁾	294.0	294.0	289.0	289.0	278.0	278.0	271.0	271.0	260.0	260.0	253.0	253.0	245.0	245.0	237.0	237.0	229.0	229.0	222.0	222.0				100
110	221.0 ⁽⁹⁾	241.0 ⁽¹¹⁾	257.0	257.0	256.0	256.0	249.0	249.0	242.0	242.0	232.0	232.0	226.0	226.0	218.0	218.0	211.0	211.0	204.0	204.0	197.0	197.0				110
120	186.0 ⁽⁷⁾	204.0 ⁽¹⁰⁾	217.0 ⁽¹¹⁾	226.0	226.0	224.0	224.0	218.0	218.0	208.0	208.0	203.0	203.0	196.0	196.0	189.0	189.0	183.0	183.0	176.0	176.0					120
130		172.0 ⁽¹⁰⁾	185.0 ⁽¹¹⁾	202.0	202.0	200.0	200.0	197.0	197.0	188.0	188.0	183.0	183.0	176.0	176.0	170.0	170.0	164.0	164.0	158.0	158.0					130
140		145.0 ⁽⁸⁾	158.0 ⁽¹⁰⁾	171.0 ⁽¹¹⁾	179.0	179.0	179.0	179.0	171.0	171.0	166.0	166.0	160.0	160.0	153.0	153.0	148.0	148.0	142.0	142.0						140
150			133.0 ⁽¹⁰⁾	146.0 ⁽¹¹⁾	162.0	162.0	161.0	161.0	156.0	156.0	151.0	151.0	145.0	145.0	139.0	139.0	134.0	134.0	128.0	128.0						150
160				111.0 ⁽⁷⁾	125.0 ⁽¹⁰⁾	135.0 ⁽¹¹⁾	145.0	145.0	141.0	141.0	138.0	138.0	132.0	132.0	126.0	126.0	121.0	121.0	115.0	115.0						160
170				106.0 ⁽¹⁰⁾	117.0 ⁽¹¹⁾	132.0	132.0	128.0	128.0	126.0	126.0	121.0	121.0	115.0	115.0	110.0	110.0	105.0	105.0							170
180				86.4 ⁽⁸⁾	97.8 ⁽¹⁰⁾	110.0 ⁽¹¹⁾	117.0	117.0	115.0	115.0	111.0	111.0	105.0	105.0	100.0	100.0	94.7	94.7								180
190				69.2 ⁽⁶⁾	78.8 ⁽⁸⁾	92.1 ⁽¹¹⁾	107.0	107.0	106.0	106.0	101.0	101.0	101.0	101.0	96.2	96.2	91.1	91.1	85.9	85.9						190
200					66.2 ⁽⁸⁾	78.8 ⁽¹¹⁾	93.5	93.5	90.6	90.6	88.0	88.0	88.0	88.0	83.1	83.1	78.0	78.0								200
220						52.0 ⁽⁹⁾	61.4 ⁽¹¹⁾	69.4 ⁽¹¹⁾	76.3	76.3	73.6	73.6	73.6	73.6	69.3	69.3	64.2	64.2								220
240							37.3 ⁽⁹⁾	48.5 ⁽¹¹⁾	53.9 ⁽¹¹⁾	62.1	62.1	62.1	62.1	62.1	58.0	58.0	52.9	52.9								240
260								26.5 ⁽⁹⁾	34.6 ⁽¹¹⁾	46.8	46.8	46.8	46.8	46.8	43.5	43.5	43.5	43.5								260
280									14.9 ⁽⁹⁾	23.9 ⁽¹¹⁾	36.1	36.1	36.1	36.1	36.1	36.1	36.1	36.1								280
300																										300

1) 12° 2) 17° 3) 22° 4) 27° 5) 32° 6) 37° 7) 42° 8) 47° 9) 52° 10) 57° 11) 62°



418,900 - 551,150 lb

ft	S 118 ft																				ft				
	W1 59 ft		W1 79 ft		W1 98 ft		W1 118 ft		W1 138 ft		W1 158 ft		W1 177 ft		W1 197 ft		W1 217 ft		W1 236 ft			W1 256 ft		W1 276 ft	
	87/85*	WVmax	87/85*	WVmax	87/85*	WVmax	87/85*	WVmax	87/85*	WVmax	87/85*	WVmax	87/85*	WVmax	87/85*	WVmax	87/85*	WVmax	87/85*	WVmax		87/85*	WVmax	87/85*	WVmax
36	945.0	945.0																						36	
38	893.0	893.0																						38	
40	847.0	847.0																						40	
50	670.0	670.0	641.0	641.0	614.0	614.0																		50	
60	552.0	552.0	529.0	529.0	508.0	508.0	489.0	489.0	470.0	470.0	455.0	455.0												60	
70	470.0	470.0	449.0	449.0	431.0	431.0	416.0	416.0	400.0	400.0	388.0	388.0	375.0	375.0	298.0	298.0								70	
80		392.0 ⁽¹¹⁾	390.0	390.0	373.0	373.0	360.0	360.0	346.0	346.0	336.0	336.0	325.0	325.0	315.0	315.0	305.0	305.0						80	
90		320.0 ⁽¹¹⁾	343.0	343.0	328.0	328.0	316.0	316.0	303.0	303.0	295.0	295.0	285.0	285.0	276.0	276.0	267.0	267.0	258.0	258.0	250.0	250.0		90	
100		264.0 ⁽⁹⁾			287.0 ⁽¹¹⁾	292.0	292.0	281.0	281.0	269.0	269.0	261.0	261.0	253.0	253.0	244.0	244.0	236.0	236.0	228.0	228.0	221.0	221.0	213.0	100
110		223.0 ⁽⁹⁾			240.0 ⁽¹¹⁾	257.0	257.0	252.0	252.0	240.0	240.0	234.0	234.0	225.0	225.0	218.0	218.0	210.0	210.0	203.0	203.0	197.0	197.0	189.0	110
120					201.0 ⁽¹⁰⁾	218.0 ⁽¹¹⁾	226.0	226.0	217.0	217.0	210.0	210.0	202.0	202.0	195.0	195.0	189.0	189.0	182.0	182.0	176.0	176.0	169.0	169.0	120
130					171.0 ⁽¹⁰⁾	185.0 ⁽¹¹⁾	202.0	202.0	197.0	197.0	190.0	190.0	183.0	183.0	176.0	176.0	170.0	170.0	164.0	164.0	158.0	158.0	151.0	151.0	130
140					141.0 ⁽⁸⁾	156.0 ⁽¹⁰⁾	171.0 ⁽¹¹⁾	179.0	179.0	174.0	174.0	166.0	166.0	160.0	160.0	154.0	154.0	147.0	147.0	142.0	142.0	136.0	136.0	130.0	140
150					120.0 ⁽⁸⁾	133.0 ⁽¹⁰⁾	146.0 ⁽¹¹⁾	161.0	161.0	159.0	159.0	152.0	152.0	146.0	146.0	140.0	140.0	134.0	134.0	128.0	128.0	122.0	122.0	116.0	150
160					109.0 ⁽⁸⁾	122.0 ⁽¹⁰⁾	134.0 ⁽¹¹⁾	143.0	143.0	139.0	139.0	133.0	133.0	127.0	127.0	121.0	121.0	116.0	116.0	111.0	111.0	105.0	105.0	100.0	160
170					90.7 ⁽⁸⁾	103.0 ⁽¹⁰⁾	115.0 ⁽¹¹⁾	131.0	131.0	128.0	128.0	122.0	122.0	116.0	116.0	110.0	110.0	105.0	105.0	100.0	100.0	94.6	94.6	89.6	170
180						82.7 ⁽⁸⁾	96.3 ⁽¹⁰⁾	109.0 ⁽¹¹⁾	117.0	117.0	112.0	112.0	106.0	106.0	101.0	101.0	95.7	95.7	90.4	90.4	85.8	85.8	80.7	80.7	180
190						68.8 ⁽⁸⁾	80.7 ⁽¹⁰⁾	91.9 ⁽¹¹⁾	107.0	107.0	104.0	104.0	97.4	97.4	92.0	92.0	87.1	87.1	81.8	81.8	76.5	76.5	71.2	71.2	190
200							63.0 ⁽⁸⁾	76.8 ⁽¹⁰⁾	84.4 ⁽¹¹⁾	92.4	92.4	89.6	89.6	84.2	84.2	79.2	79.2	74.1	74.1	68.8	68.8	63.5	63.5	58.2	200
220								50.1 ⁽⁹⁾	60.3 ⁽¹¹⁾	67.7 ⁽¹¹⁾	75.3	75.3	70.9	70.9	65.8	65.8	60.7	60.7	55.6	55.6	50.5	50.5	45.4	45.4	220
240									25.8 ⁽⁷⁾	34.6 ⁽⁹⁾	46.1 ⁽¹¹⁾	51.5 ⁽¹¹⁾	60.5	60.5	54.7	54.7	49.6	49.6	44.5	44.5	39.4	39.4	34.3	34.3	240
260																									260
280																									280

1) 12° 2) 17° 3) 22° 4) 27° 5) 32° 6) 37° 7) 42° 8) 47° 9) 52° 10) 57° 11) 62°



418,900 - 551,150 lb

ft	S 138 ft																				ft				
	W1 59 ft		W1 79 ft		W1 98 ft		W1 118 ft		W1 138 ft		W1 158 ft		W1 177 ft		W1 197 ft		W1 217 ft		W1 236 ft			W1 256 ft		W1 276 ft	
	87/85*	WVmax	87/85*	WVmax	87/85*	WVmax	87/85*	WVmax	87/85*	WVmax	87/85*	WVmax	87/85*	WVmax	87/85*	WVmax	87/85*	WVmax	87/85*	WVmax		87/85*	WVmax	87/85*	WVmax
38	845.0	845.0																						38	
40	803.0	803.0																						40	
50	639.0	639.0	614.0	614.0	586.0	586.0																		50	
60	529.0	529.0	509.0	509.0	487.0	487.0	469.0	469.0	453.0	453.0														60	
70	451.0	451.0	433.0	433.0	415.0	415.0	400.0	400.0	386.0	386.0	373.0	373.0	361.0	361.0										70	
80	381.0*	381.0	376.0	376.0	359.0	359.0	347.0	347.0	335.0	335.0	324.0	324.0	313.0	313.0	302.0	302.0	293.0	293.0						80	
90		315.0 ⁽¹¹⁾	333.0	333.0	316.0	316.0	305.0	305.0	294.0	294.0	284.0	284.0	275.0	275.0	265.0	265.0	257.0	257.0	248.0	248.0	191.0	191.0		90	
100		263.0 ⁽¹¹⁾	288.0*	288.0	281.0	281.0	270.0	270.0	261.0	261.0	252.0	252.0	243.0	243.0	235.0	235.0	227.0	227.0	219.0	219.0	212.0	212.0	205.0	100	
110		219.0 ⁽⁹⁾			239.0 ⁽¹¹⁾	254.0	254.0	243.0	243.0	233.0	233.0	225.0	225.0	217.0	217.0	210.0	210.0	202.0	202.0	195.0	195.0	189.0	189.0	182.0	110
120		185.0 ⁽⁹⁾			202.0 ⁽¹¹⁾	220.0*	220.0	220.0	220.0	210.0	210.0	203.0	203.0	195.0	195.0	188.0	188.0	182.0	182.0	175.0	175.0	169.0	169.0	162.0	120
130					170.0 ⁽¹⁰⁾	183.0 ⁽¹¹⁾	201.0	201.0	191.0	191.0	183.0	183.0	176.0	176.0	170.0	170.0	163.0	163.0	157.0	157.0	151.0	151.0	145.0	145.0	130
140					143.0 ⁽¹⁰⁾	154.0 ⁽¹¹⁾	175.0*	175.0	175.0	175.0	167.0	167.0	160.0	160.0	154.0	154.0	148.0	148.0	141.0	141.0	136.0	136.0	130.0	130.0	140
150						129.0 ⁽¹⁰⁾	143.0 ⁽¹¹⁾	161.0	161.0	153.0	153.0	146.0	146.0	140.0	140.0	134.0	134.0	128.0	128.0	123.0	123.0	117.0	117.0	111.0	150
160						107.0 ⁽¹⁰⁾	122.0 ⁽¹¹⁾	141.0	141.0	134.0 ⁽¹¹⁾	141.0	141.0	134.0	134.0	128.0	128.0	122.0	122.0	116.0	116.0	111.0	111.0	105.0	105.0	160
170						85.7 ⁽⁸⁾	102.0 ⁽¹⁰⁾	113.0 ⁽¹¹⁾	129.0	129.0	123.0	123.0	117.0	117.0	111.0	111.0	106.0	106.0	101.0	101.0	95.2	95.2	89.9	89.9	170
180						70.6 ⁽⁸⁾	84.1 ⁽¹⁰⁾	93.9 ⁽¹¹⁾	105.0 ⁽¹¹⁾	114.0	114.0	107.0	107.0	102.0	102.0	96.1	96.1	91.2	91.2	86.0	86.0	80.7	80.7	75.4	180
190							64.8 ⁽⁸⁾	77.2 ⁽¹⁰⁾	88.4 ⁽¹¹⁾	106.0	106.0	99.0	99.0	93.1	93.1	87.6	87.6	82.9	82.9	77.6	77.6	72.3	72.3	67.0	190
200							51.5 ⁽⁸⁾	62.9 ⁽¹⁰⁾	74.6 ⁽¹¹⁾	83.0 ⁽¹¹⁾	91.2	91.2	85.5	85.5	80.1	80.1	75.2	75.2	70.1	70.1	64.8	64.8	59.5	59.5	200
220								34.7 ⁽⁸⁾	48.1 ⁽¹¹⁾	56.2 ⁽¹¹⁾	64.4 ⁽¹¹⁾	72.9	72.9	67.1	67.1	62.1	62.1	57.0	57.0	51.9	51.9	46.8	46.8	41.7	220
240									22.6 ⁽⁹⁾	32.8 ⁽¹¹⁾	41.4 ⁽¹¹⁾	47.6 ⁽¹¹⁾	56.9	56.9	51.3	51.3	46.3	46.3	41.2	41.2	36.1	36.1	31.0	31.0	240
260																									260
280																									280

1) 12° 2) 17° 3) 22° 4) 27° 5) 32° 6) 37° 7) 42° 8) 47° 9) 52° 10) 57° 11) 62°



418,900 - 551,150 lb

S 158 ft

ft	W1 59 ft		W1 79 ft		W1 98 ft		W1 118 ft		W1 138 ft		W1 158 ft		W1 177 ft		W1 197 ft		W1 217 ft		W1 236 ft		W1 256 ft		W1 276 ft		ft
	87/85*	WVmax	87/85*	WVmax	87/85*	WVmax	87/85*	WVmax	87/85*	WVmax	87/85*	WVmax	87/85*	WVmax	87/85*	WVmax	87/85*	WVmax	87/85*	WVmax	87/85*	WVmax	87/85*	WVmax	
40	763.0	763.0																							40.0
50	611.0	611.0	586.0	586.0	560.0	560.0																			50.0
60	508.0	508.0	488.0	488.0	467.0	467.0	450.0	450.0	434.0	434.0															60.0
70	434.0	434.0	416.0	416.0	398.0	398.0	384.0	384.0	371.0	371.0	358.0	358.0													70.0
80	364.0*	365.0 ⁽¹⁾	362.0	362.0	345.0	345.0	333.0	333.0	322.0	322.0	311.0	311.0	300.0	300.0	293.0	293.0									80.0
90		306.0 ⁽¹⁾	320.0	320.0	304.0	304.0	293.0	293.0	283.0	283.0	273.0	273.0	264.0	264.0	257.0	257.0	247.0	247.0	241.0	241.0					90.0
100		254.0 ⁽¹⁾	275.0*	275.0	271.0	271.0	260.0	260.0	251.0	251.0	242.0	242.0	234.0	234.0	228.0	228.0	218.0	218.0	213.0	213.0	204.0	204.0	196.0	196.0	100.0
110		210.0 ⁽¹⁾		231.0 ⁽¹⁾	244.0	244.0	234.0	234.0	225.0	225.0	216.0	216.0	209.0	209.0	204.0	204.0	194.0	194.0	190.0	190.0	181.0	181.0	174.0	174.0	110.0
120		177.0 ⁽⁹⁾		194.0 ⁽¹⁾	212.0*	212.0	211.0	211.0	203.0	203.0	195.0	195.0	188.0	188.0	183.0	183.0	174.0	174.0	170.0	170.0	161.0	161.0	155.0	155.0	120.0
130		147.0 ⁽⁹⁾		161.0 ⁽¹⁰⁾	176.0 ⁽¹⁾	176.0	193.0	193.0	184.0	184.0	176.0	176.0	169.0	169.0	165.0	165.0	157.0	157.0	153.0	153.0	145.0	145.0	139.0	139.0	130.0
140				137.0 ⁽¹⁰⁾	149.0 ⁽¹⁾	169.0*	169.0	168.0	168.0	161.0	161.0	154.0	154.0	150.0	150.0	142.0	142.0	138.0	138.0	130.0	130.0	124.0	124.0	140.0	
150				113.0 ⁽¹⁰⁾	122.0 ⁽¹⁰⁾		138.0 ⁽¹⁾	155.0	155.0	147.0	147.0	140.0	140.0	136.0	136.0	128.0	128.0	125.0	125.0	117.0	117.0	112.0	112.0	150.0	
160					103.0 ⁽¹⁰⁾		116.0 ⁽¹⁾	136.0*	136.0	135.0	135.0	128.0	128.0	124.0	124.0	117.0	117.0	113.0	113.0	106.0	106.0	100.0	100.0	160.0	
170					83.4 ⁽¹⁰⁾		94.5 ⁽¹⁰⁾		108.0 ⁽¹⁾	125.0	125.0	118.0	118.0	114.0	114.0	106.0	106.0	103.0	103.0	95.8	95.8	90.3	90.3	170.0	
180					63.6 ⁽⁸⁾		78.2 ⁽¹⁰⁾		90.3 ⁽¹⁾	110.0	110.0	109.0	109.0	104.0	104.0	96.9	96.9	93.8	93.8	86.6	86.6	81.4	81.4	180.0	
190					49.4 ⁽⁸⁾		61.8 ⁽¹⁰⁾		71.8 ⁽¹⁰⁾		84.3 ⁽¹⁾	101.0	101.0	96.3	96.3	88.6	88.6	85.5	85.5	78.5	78.5	73.3	73.3	190.0	
200							44.5 ⁽⁸⁾		57.8 ⁽¹⁰⁾		69.7 ⁽¹⁾	87.7*	87.7	89.0	89.0	81.2	81.2	78.1	78.1	71.1	71.1	66.0	66.0	200.0	
220									17.6 ⁽⁴⁾		43.2 ⁽¹⁾		51.6 ⁽¹⁾	72.2*	72.2	68.9	68.9	65.3	65.3	58.4	58.4	53.3	53.3	220.0	
240													28.4 ⁽¹⁾		38.5 ⁽¹⁾	54.9*	54.9	55.0	55.0	47.9	47.9	42.8	42.8	240.0	
260															23.3 ⁽¹⁾				31.6 ⁽¹⁾	39.4	39.4	34.0	34.0	260.0	
280																					17.2 ⁽¹⁾	27.1	27.1	280.0	

1) 12° 2) 17° 3) 22° 4) 27° 5) 32° 6) 37° 7) 42° 8) 47° 9) 52° 10) 57° 11) 62°



418,900 - 551,150 lb

S 177 ft

ft	W1 59 ft		W1 79 ft		W1 98 ft		W1 118 ft		W1 138 ft		W1 158 ft		W1 177 ft		W1 197 ft		W1 217 ft		W1 236 ft		ft				
	87/85*	WVmax	87/85*	WVmax	87/85*	WVmax	87/85*	WVmax	87/85*	WVmax	87/85*	WVmax	87/85*	WVmax	87/85*	WVmax	87/85*	WVmax	87/85*	WVmax					
40	723.0	723.0																						40	
50	583.0	583.0	560.0	560.0																					50
60	486.0	486.0	468.0	468.0	449.0	449.0	430.0	430.0																	60
70	416.0	416.0	401.0	401.0	383.0	383.0	368.0	368.0	355.0	355.0	345.0	345.0													70
80	347.0*	353.0 ⁽¹⁾	349.0	349.0	333.0	333.0	320.0	320.0	309.0	309.0	300.0	300.0	288.0	288.0	281.0	281.0									80
90		295.0 ⁽¹⁾	309.0	309.0	294.0	294.0	281.0	281.0	271.0	271.0	264.0	264.0	253.0	253.0	247.0	247.0	236.0	236.0	230.0	230.0	230.0	230.0			90
100		241.0 ⁽¹⁾	264.0*	264.0	262.0	262.0	250.0	250.0	241.0	241.0	235.0	235.0	224.0	224.0	219.0	219.0	209.0	209.0	204.0	204.0	204.0	204.0			100
110		202.0 ⁽¹⁾		224.0 ⁽¹⁾	236.0	236.0	224.0	224.0	216.0	216.0	210.0	210.0	200.0	200.0	195.0	195.0	186.0	186.0	182.0	182.0	182.0	182.0			110
120		166.0 ⁽⁹⁾		186.0 ⁽¹⁾	203.0*	203.0	203.0	203.0	194.0	194.0	189.0	189.0	180.0	180.0	175.0	175.0	167.0	167.0	163.0	163.0	163.0	163.0			120
130		139.0 ⁽⁹⁾		156.0 ⁽¹⁾	171.0 ⁽¹⁾	171.0	185.0	185.0	176.0	176.0	171.0	171.0	162.0	162.0	158.0	158.0	150.0	150.0	146.0	146.0	146.0	146.0			130
140		112.0 ⁽⁹⁾		129.0 ⁽¹⁰⁾	143.0 ⁽¹⁾	160.0*	160.0	161.0	161.0	156.0	156.0	147.0	147.0	143.0	143.0	135.0	135.0	132.0	132.0	132.0	132.0			140	
150				108.0 ⁽¹⁰⁾	119.0 ⁽¹⁾		132.0 ⁽¹⁾	148.0	148.0	142.0	142.0	134.0	134.0	130.0	130.0	122.0	122.0	119.0	119.0	119.0	119.0			150	
160				85.7 ⁽¹⁰⁾	96.7 ⁽¹⁰⁾		110.0 ⁽¹⁾	128.0*	128.0	131.0	131.0	122.0	122.0	119.0	119.0	111.0	111.0	108.0	108.0	108.0	108.0			160	
170					78.6 ⁽¹⁰⁾		90.0 ⁽¹⁾		103.0 ⁽¹⁾	121.0	121.0	112.0	112.0	109.0	109.0	101.0	101.0	98.0	98.0	98.0	98.0			170	
180					60.5 ⁽¹⁰⁾		71.5 ⁽¹⁰⁾		84.6 ⁽¹⁾	105.0*	105.0	103.0	103.0	99.6	99.6	91.9	91.9	89.0	89.0	89.0	89.0			180	
190					43.2 ⁽⁸⁾		56.2 ⁽¹⁰⁾		68.0 ⁽¹⁾		81.0 ⁽¹⁾	96.0	96.0	91.6	91.6	83.9	83.9	81.0	81.0	81.0	81.0			190	
200					30.3 ⁽⁸⁾		40.9 ⁽¹⁰⁾		51.8 ⁽¹⁰⁾		66.0 ⁽¹⁾	82.1*	82.1	84.5	84.5	76.8	76.8	73.8	73.8	73.8	73.8			200	
220									25.4 ⁽¹⁰⁾		39.4 ⁽¹⁾		46.8 ⁽¹⁾	66.6*	66.6	64.7	64.7	61.4	61.4	61.4	61.4			220	
240											15.2 ⁽¹⁾				34.1 ⁽¹⁾	49.6*	49.6	51.3	51.3	51.3	51.3			240	
260																15.5 ⁽¹⁰⁾	38.0*	38.0	38.0	38.0				260	

1) 12° 2) 17° 3) 22° 4) 27° 5) 32° 6) 37° 7) 42° 8) 47° 9) 52° 10) 57° 11) 62°



418,900 - 551,150 lb

ft	S 197 ft														ft
	W1 59 ft		W1 79 ft		W1 98 ft		W1 118 ft		W1 138 ft		W1 158 ft		W1 177 ft		
	87/85*	WVmax	87/85*	WVmax	87/85*	WVmax	87/85*	WVmax	87/85*	WVmax	87/85*	WVmax	87/85*	WVmax	
50	557.0	557.0	534.0	534.0											50
60	466.0	466.0	448.0	448.0	429.0	429.0	413.0	413.0							60
70	400.0	400.0	384.0	384.0	367.0	367.0	354.0	354.0	340.0	340.0	330.0	330.0			70
80	331.0*	342.0 ⁽¹¹⁾	335.0	335.0	320.0	320.0	309.0	309.0	296.0	296.0	287.0	287.0	278.0	278.0	80
90		285.0 ⁽¹¹⁾	296.0	296.0	282.0	282.0	272.0	272.0	260.0	260.0	253.0	253.0	245.0	245.0	90
100		234.0 ⁽¹¹⁾	251.0*	255.0 ⁽¹¹⁾	251.0	251.0	242.0	242.0	231.0	231.0	225.0	225.0	217.0	217.0	100
110		194.0 ⁽¹¹⁾		215.0 ⁽¹¹⁾	226.0	226.0	217.0	217.0	207.0	207.0	201.0	201.0	194.0	194.0	110
120		158.0 ⁽¹¹⁾		178.0 ⁽¹¹⁾	193.0*	193.0	196.0	196.0	186.0	186.0	181.0	181.0	174.0	174.0	120
130				149.0 ⁽¹¹⁾		164.0 ⁽¹¹⁾	179.0	179.0	169.0	169.0	164.0	164.0	157.0	157.0	130
140				120.0 ⁽¹⁰⁾		135.0 ⁽¹¹⁾	153.0*	153.0	154.0	154.0	149.0	149.0	143.0	143.0	140
150				100.0 ⁽¹⁰⁾		112.0 ⁽¹¹⁾		128.0 ⁽¹¹⁾	141.0	141.0	136.0	136.0	130.0	130.0	150
160				80.2 ⁽¹⁰⁾		88.9 ⁽¹⁰⁾		105.0 ⁽¹¹⁾	121.0*	121.0	125.0	125.0	119.0	119.0	160
170				60.3 ⁽¹⁰⁾		72.2 ⁽¹⁰⁾		86.0 ⁽¹¹⁾		97.4 ⁽¹¹⁾	116.0	116.0	109.0	109.0	170
180						55.5 ⁽¹⁰⁾		66.2 ⁽¹⁰⁾		78.8 ⁽¹¹⁾	98.2*	98.2	100.0	100.0	180
190						38.8 ⁽¹⁰⁾		51.8 ⁽¹⁰⁾		62.8 ⁽¹¹⁾	76.4 ⁽¹¹⁾	76.4 ⁽¹¹⁾	92.7	92.7	190
200								37.5 ⁽¹⁰⁾		28.1 ⁽⁵⁾	60.9 ⁽¹¹⁾	60.9 ⁽¹¹⁾	77.8*	77.8	200
220														43.9 ⁽¹¹⁾	220

1) 12° 2) 17° 3) 22° 4) 27° 5) 32° 6) 37° 7) 42° 8) 47° 9) 52° 10) 57° 11) 62°

Lifting heights

Hauteurs de levage

SW1

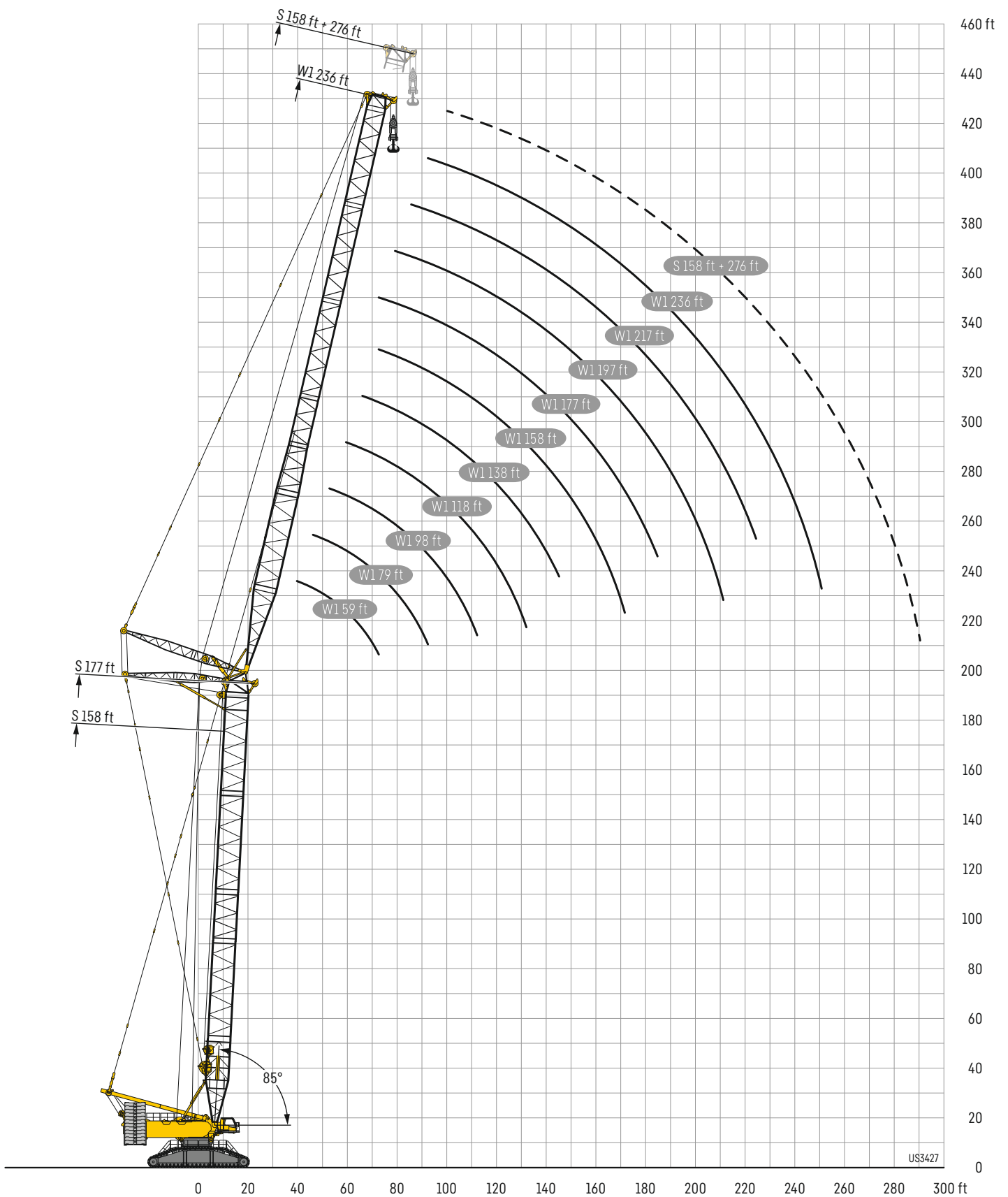

SDWB/SDWBV/SDWBW

S 138

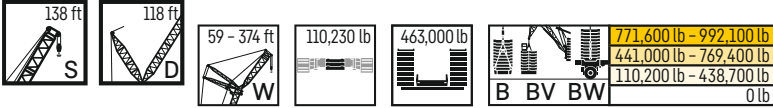

ft	B BV BW	S 138 ft																	
		W 59 ft		W 79 ft		W 98 ft		W 118 ft		W 138 ft		W 158 ft		W 177 ft		W 197 ft		W 217 ft	
		87°/85	WVmax	87°/85	WVmax	87°/85	WVmax	87°/85	WVmax	87°/85	WVmax	87°/85	WVmax	87°/85	WVmax	87°/85	WVmax	87°/85	WVmax
38	BV	1432.0*	1432.0*																
40	BV	1432.0*	1432.0*																
50	BV	1417.0	1417.0	1372.0	1372.0	1256.0*	1264.0 ⁽¹⁾												
60	BV	1086.0	1279.0 ⁽¹⁾	1148.0	1232.0 ⁽¹⁾	1242.0	1242.0	1113.0	1113.0	968.0*	971.0 ⁽¹⁾								
70	BV	844.0	1104.0 ⁽²⁾	889.0	1086.0 ⁽²⁾	1122.0	1122.0	1072.0	1072.0	967.0	967.0	844.0*	858.0 ⁽¹⁾	755.0*	757.0 ⁽¹⁾				
80	BV	579.0	940.0 ⁽³⁾	719.0	938.0 ⁽²⁾	987.0	988.0 ⁽⁴⁾	967.0	967.0	927.0	927.0	846.0	846.0	758.0	758.0	665.0*	672.0 ⁽¹⁾	593.0*	594.0 ⁽¹⁾
90	BV		807.0 ⁽⁵⁾	615.0	808.0 ⁽³⁾	844.0	862.0 ⁽⁴⁾	841.0	851.0 ⁽⁵⁾	835.0	836.0 ⁽³⁾	811.0	811.0	740.0	740.0	665.0	665.0	591.0	591.0
100	BV		1064.0 ⁽¹⁾	614.0	1020.0 ⁽¹⁾	846.0	1022.0 ⁽²⁾	848.0	1021.0 ⁽¹⁾	846.0	918.0 ⁽¹⁾	817.0	857.0 ⁽¹⁾	751.0	757.0 ⁽¹⁾	675.0	675.0	598.0	598.0
110	BV		720.0 ⁽⁶⁾	456.0	706.0 ⁽²⁾	721.0	753.0 ⁽⁵⁾	725.0	748.0 ⁽⁴⁾	723.0	744.0 ⁽³⁾	727.0	732.0 ⁽³⁾	707.0	707.0	647.0	647.0	578.0	578.0
120	BV		932.0 ⁽²⁾	459.0	921.0 ⁽¹⁾	724.0	932.0 ⁽²⁾	727.0	929.0 ⁽²⁾	723.0	863.0 ⁽¹⁾	727.0	844.0 ⁽¹⁾	710.0	749.0 ⁽¹⁾	656.0	667.0 ⁽¹⁾	587.0	589.0 ⁽¹⁾
130	BV		637.0 ⁽⁶⁾		637.0 ⁽⁴⁾	585.0	664.0 ⁽⁷⁾	635.0	664.0 ⁽⁵⁾	630.0	658.0 ⁽⁴⁾	632.0	659.0 ⁽³⁾	632.0	639.0 ⁽³⁾	619.0	619.0	565.0	565.0
140	BV		816.0 ⁽²⁾		823.0 ⁽¹⁾	591.0	847.0 ⁽²⁾	635.0	838.0 ⁽²⁾	633.0	803.0 ⁽¹⁾	633.0	789.0 ⁽¹⁾	633.0	730.0 ⁽¹⁾	623.0	659.0 ⁽¹⁾	572.0	581.0 ⁽¹⁾
150	BV		563.0 ⁽⁸⁾		573.0 ⁽⁵⁾	406.0	606.0 ⁽⁸⁾	569.0	597.0 ⁽⁵⁾	556.0	594.0 ⁽⁴⁾	560.0	586.0 ⁽³⁾	558.0	584.0 ⁽³⁾	558.0	566.0 ⁽³⁾	543.0	543.0
160	BV		723.0 ⁽⁵⁾		728.0 ⁽²⁾	409.0	767.0 ⁽³⁾	569.0	761.0 ⁽²⁾	559.0	742.0 ⁽¹⁾	560.0	734.0 ⁽¹⁾	560.0	692.0 ⁽¹⁾	558.0	634.0 ⁽¹⁾	547.0	573.0 ⁽¹⁾
170	BV				513.0 ⁽⁵⁾		541.0 ⁽⁹⁾	495.0	542.0 ⁽⁷⁾	498.0	540.0 ⁽⁵⁾	499.0	534.0 ⁽⁴⁾	498.0	528.0 ⁽⁵⁾	497.0	521.0 ⁽⁵⁾	492.0	502.0 ⁽⁵⁾
180	BV				655.0 ⁽³⁾		694.0 ⁽⁴⁾	497.0	693.0 ⁽²⁾	499.0	681.0 ⁽¹⁾	499.0	678.0 ⁽¹⁾	499.0	654.0 ⁽¹⁾	499.0	603.0 ⁽¹⁾	494.0	532.0 ⁽²⁾
190	BV				459.0 ⁽⁹⁾		485.0 ⁽⁹⁾	342.0	505.0 ⁽⁹⁾	456.0	498.0 ⁽⁴⁾	451.0	486.0 ⁽⁴⁾	447.0	480.0 ⁽⁴⁾	447.0	476.0 ⁽⁵⁾	444.0	468.0 ⁽⁵⁾
200	BV				560.0 ⁽⁴⁾		630.0 ⁽⁵⁾	347.0	632.0 ⁽³⁾	457.0	626.0 ⁽²⁾	451.0	623.0 ⁽¹⁾	448.0	616.0 ⁽¹⁾	449.0	572.0 ⁽¹⁾	445.0	510.0 ⁽²⁾
210	BV						439.0 ⁽⁹⁾		455.0 ⁽⁹⁾	409.0	452.0 ⁽⁷⁾	415.0	448.0 ⁽⁴⁾	405.0	441.0 ⁽⁴⁾	405.0	438.0 ⁽⁴⁾	401.0	434.0 ⁽³⁾
220	BV						569.0 ⁽⁶⁾		571.0 ⁽⁵⁾	411.0	573.0 ⁽²⁾	415.0	567.0 ⁽¹⁾	405.0	578.0 ⁽¹⁾	406.0	541.0 ⁽¹⁾	401.0	480.0 ⁽²⁾
230	BV						395.0 ⁽⁸⁾		409.0 ⁽¹¹⁾		421.0 ⁽⁹⁾	377.0	414.0 ⁽⁶⁾	369.0	409.0 ⁽⁵⁾	369.0	409.0 ⁽⁴⁾	365.0	407.0 ⁽¹⁾
240	BV						520.0 ⁽⁸⁾		521.0 ⁽⁴⁾		519.0 ⁽²⁾	377.0	518.0 ⁽²⁾	370.0	541.0 ⁽¹⁾	369.0	510.0 ⁽¹⁾	364.0	449.0 ⁽²⁾
250	BV						354.0 ⁽⁸⁾		373.0 ⁽¹⁰⁾		382.0 ⁽¹⁰⁾	343.0	384.0 ⁽⁸⁾	344.0	375.0 ⁽⁶⁾	340.0	374.0 ⁽⁴⁾	332.0	381.0 ⁽¹⁾
260	BV						478.0 ⁽⁸⁾		482.0 ⁽⁵⁾		475.0 ⁽⁴⁾	343.0	475.0 ⁽²⁾	345.0	503.0 ⁽¹⁾	341.0	478.0 ⁽¹⁾	333.0	423.0 ⁽²⁾
270	BV						316.0 ⁽⁸⁾		338.0 ⁽¹⁰⁾		348.0 ⁽¹¹⁾		354.0 ⁽⁸⁾	316.0	348.0 ⁽⁶⁾	317.0	345.0 ⁽⁵⁾	306.0	355.0 ⁽¹⁾
280	BV						430.0 ⁽⁸⁾		444.0 ⁽⁷⁾		441.0 ⁽⁴⁾		442.0 ⁽³⁾	316.0	465.0 ⁽¹⁾	317.0	447.0 ⁽¹⁾	306.0	403.0 ⁽²⁾
290	BV						298.0 ⁽⁸⁾		299.0 ⁽⁸⁾		320.0 ⁽¹⁰⁾		329.0 ⁽⁹⁾	287.0	325.0 ⁽⁸⁾	292.0	321.0 ⁽⁵⁾	287.0	329.0 ⁽¹⁾
300	BV						409.0 ⁽⁸⁾		414.0 ⁽⁵⁾		411.0 ⁽⁵⁾		411.0 ⁽⁵⁾	288.0	427.0 ⁽¹⁾	291.0	416.0 ⁽¹⁾	288.0	383.0 ⁽²⁾
310	BV						265.0 ⁽⁸⁾		295.0 ⁽¹⁰⁾		309.0 ⁽¹¹⁾		303.0 ⁽⁷⁾	268.0	303.0 ⁽⁷⁾	268.0	301.0 ⁽⁶⁾	267.0	302.0 ⁽¹⁾
320	BV						369.0 ⁽⁸⁾		386.0 ⁽⁴⁾		385.0 ⁽⁴⁾		385.0 ⁽⁴⁾	268.0	389.0 ⁽¹⁾	268.0	385.0 ⁽¹⁾	267.0	363.0 ⁽²⁾
330	BV						236.0 ⁽⁸⁾		256.0 ⁽¹¹⁾		256.0 ⁽¹¹⁾		256.0 ⁽¹¹⁾		264.0 ⁽¹¹⁾		262.0 ⁽⁶⁾	227.0	256.0 ⁽⁵⁾
340	BV						325.0 ⁽⁸⁾		336.0 ⁽⁷⁾		336.0 ⁽⁷⁾		336.0 ⁽⁷⁾		331.0 ⁽⁴⁾		330.0 ⁽³⁾	228.0	323.0 ⁽²⁾
350	BV						208.0 ⁽⁹⁾		208.0 ⁽⁹⁾		208.0 ⁽⁹⁾		208.0 ⁽⁹⁾		227.0 ⁽¹¹⁾		235.0 ⁽¹¹⁾		232.0 ⁽⁸⁾
360	BV						283.0 ⁽⁹⁾		283.0 ⁽⁹⁾		283.0 ⁽⁹⁾		283.0 ⁽⁹⁾		285.0 ⁽⁸⁾		286.0 ⁽⁴⁾		283.0 ⁽²⁾
370	BV						158.0 ⁽⁷⁾		158.0 ⁽⁷⁾		158.0 ⁽⁷⁾		158.0 ⁽⁷⁾		178.0 ⁽⁹⁾		203.0 ⁽¹⁾		204.0 ⁽¹¹⁾
380	BV						233.0 ⁽⁷⁾		233.0 ⁽⁷⁾		233.0 ⁽⁷⁾		233.0 ⁽⁷⁾		250.0 ⁽⁹⁾		249.0 ⁽⁴⁾		247.0 ⁽⁴⁾
390	BV														138.0 ⁽⁷⁾		159.0 ⁽⁹⁾		172.0 ⁽¹¹⁾
400	BV														209.0 ⁽⁷⁾		225.0 ⁽⁸⁾		220.0 ⁽⁴⁾
410	BV																124.0 ⁽⁷⁾		138.0 ⁽⁹⁾
420	BV																182.0 ⁽⁷⁾		199.0 ⁽⁶⁾
430	BV																		112.0 ⁽⁷⁾
440	BV																		159.0 ⁽⁷⁾

1) 12° 2) 17° 3) 22° 4) 27° 5) 32° 6) 37° 7) 42° 8) 47° 9) 52° 10) 57° 11) 62°

SDWB/SDWBV/SDWBW

S 138

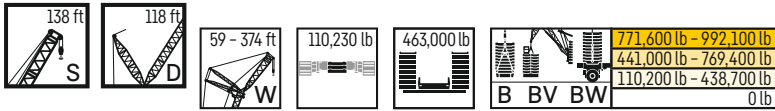

		S 138 ft															
ft	B BV BW	W 236 ft		W 256 ft		W 276 ft		W 295 ft		W 315 ft		W 335 ft		W 354 ft		W 374 ft	
		87°/85	WVmax	87°/85	WVmax	87°/85	WVmax	87°/85	WVmax	87°/85	WVmax	87°/85	WVmax	87°/85	WVmax	87°/85	WVmax
80	BV	530.0*	530.0*														
80	BW																
90	B	519.0*	523.0 ⁽¹⁾	462.0*	463.0 ⁽¹⁾	410.0*	410.0*										
90	BV																
90	BW																
100	B	517.0	517.0	458.0	458.0	402.0*	405.0 ⁽¹⁾	357.0*	357.0*	319.0*	319.0*						
100	BV																
100	BW																
110	B	523.0	523.0	463.0	463.0												
110	BV	506.0	506.0	450.0	450.0	400.0	400.0	352.0	352.0	313.0*	314.0 ⁽¹⁾	277.0*	277.0*	240.0*	240.0*		
110	BW																
120	B	513.0	513.0	455.0	455.0	403.0	403.0	355.0	355.0								
120	BV	496.0	496.0	441.0	441.0	393.0	393.0	345.0	345.0	310.0	310.0	272.0*	273.0 ⁽¹⁾	234.0*	235.0 ⁽¹⁾	210.0*	210.0*
120	BW																
130	B	503.0	503.0	447.0	447.0	397.0	397.0	348.0	348.0	312.0	312.0	275.0	275.0				
130	BV	478.0	478.0	433.0	433.0	386.0	386.0	337.0	337.0	305.0	305.0	270.0	270.0	232.0	232.0	205.0*	207.0 ⁽¹⁾
130	BW																
140	B	484.0	494.0 ⁽¹⁾	440.0	440.0	391.0	391.0	341.0	341.0	307.0	307.0	271.0	271.0	233.0	233.0		
140	BV	440.0	448.0 ⁽²⁾	419.0	419.0	380.0	380.0	330.0	331.0 ⁽²⁾	300.0	300.0	265.0	265.0	227.0	227.0	204.0	204.0
140	BW																
150	B	441.0	477.0 ⁽²⁾	424.0	432.0 ⁽²⁾	384.0	385.0 ⁽²⁾	333.0	334.0 ⁽²⁾	303.0	303.0	267.0	267.0	228.0	228.0	205.0	205.0
150	BV	400.0	422.0 ⁽²⁾	394.0	404.0 ⁽²⁾	369.0	372.0 ⁽²⁾	323.0	326.0 ⁽²⁾	295.0	295.0	261.0	261.0	222.0	222.0	199.0	199.0
150	BW																
160	B	401.0	460.0 ⁽²⁾	396.0	424.0 ⁽²⁾	373.0	379.0 ⁽²⁾	326.0	330.0 ⁽²⁾	298.0	299.0 ⁽²⁾	263.0	263.0	223.0	223.0	200.0	200.0
160	BV	363.0	394.0 ⁽³⁾	363.0	383.0 ⁽²⁾	352.0	364.0 ⁽²⁾	316.0	322.0 ⁽²⁾	290.0	292.0 ⁽²⁾	256.0	257.0 ⁽²⁾	217.0	217.0	195.0	195.0
160	BW																
170	B	363.0	433.0 ⁽²⁾	363.0	410.0 ⁽²⁾	354.0	373.0 ⁽²⁾	319.0	326.0 ⁽²⁾	293.0	295.0 ⁽²⁾	258.0	259.0 ⁽²⁾	218.0	218.0	196.0	196.0
170	BV	333.0	366.0 ⁽³⁾	331.0	357.0 ⁽³⁾	327.0	346.0 ⁽²⁾	307.0	318.0 ⁽²⁾	283.0	288.0 ⁽²⁾	250.0	253.0 ⁽²⁾	212.0	213.0 ⁽²⁾	192.0	192.0
170	BW																
180	B	332.0	407.0 ⁽²⁾	331.0	389.0 ⁽²⁾	328.0	361.0 ⁽²⁾	310.0	322.0 ⁽²⁾	286.0	291.0 ⁽²⁾	252.0	255.0 ⁽²⁾	214.0	215.0 ⁽²⁾	193.0	193.0
180	BV	305.0	338.0 ⁽¹⁾	303.0	333.0 ⁽³⁾	300.0	324.0 ⁽³⁾	293.0	305.0 ⁽²⁾	274.0	284.0 ⁽²⁾	243.0	249.0 ⁽²⁾	207.0	210.0 ⁽²⁾	188.0	189.0 ⁽²⁾
180	BW																
190	B	305.0	384.0 ⁽¹⁾	303.0	367.0 ⁽²⁾	300.0	345.0 ⁽²⁾	295.0	315.0 ⁽²⁾	277.0	288.0 ⁽²⁾	245.0	252.0 ⁽²⁾	209.0	212.0 ⁽²⁾	190.0	191.0 ⁽²⁾
190	BV	280.0	316.0 ⁽¹⁾	280.0	307.0 ⁽³⁾	277.0	306.0 ⁽³⁾	276.0	293.0 ⁽³⁾	262.0	273.0 ⁽²⁾	236.0	246.0 ⁽²⁾	202.0	206.0 ⁽²⁾	184.0	187.0 ⁽²⁾
190	BW																
200	B	281.0	365.0 ⁽²⁾	280.0	348.0 ⁽²⁾	276.0	329.0 ⁽²⁾	276.0	306.0 ⁽²⁾	264.0	281.0 ⁽²⁾	238.0	248.0 ⁽²⁾	203.0	208.0 ⁽²⁾	186.0	188.0 ⁽²⁾
200	BV	262.0	294.0 ⁽¹⁾	259.0	287.0 ⁽⁴⁾	255.0	283.0 ⁽³⁾	255.0	280.0 ⁽³⁾	248.0	264.0 ⁽³⁾	229.0	239.0 ⁽²⁾	196.0	202.0 ⁽²⁾	180.0	184.0 ⁽²⁾
200	BW																
220	B	228.0	348.0 ⁽²⁾	258.0	332.0 ⁽²⁾	255.0	314.0 ⁽²⁾	255.0	297.0 ⁽²⁾	249.0	273.0 ⁽²⁾	231.0	243.0 ⁽²⁾	198.0	205.0 ⁽²⁾	181.0	186.0 ⁽²⁾
220	BV	228.0	254.0 ⁽⁵⁾	226.0	249.0 ⁽⁵⁾	219.0	249.0 ⁽⁴⁾	218.0	244.0 ⁽³⁾	215.0	240.0 ⁽³⁾	210.0	228.0 ⁽³⁾	188.0	194.0 ⁽²⁾	171.0	178.0 ⁽²⁾
220	BW																
240	B	229.0	313.0 ⁽²⁾	226.0	300.0 ⁽²⁾	219.0	286.0 ⁽²⁾	218.0	275.0 ⁽²⁾	215.0	256.0 ⁽²⁾	211.0	232.0 ⁽²⁾	189.0	197.0 ⁽²⁾	172.0	180.0 ⁽²⁾
240	BV	196.0	227.0 ⁽⁶⁾	196.0	223.0 ⁽⁵⁾	194.0	219.0 ⁽⁴⁾	188.0	215.0 ⁽⁴⁾	185.0	211.0 ⁽³⁾	185.0	203.0 ⁽²⁾	179.0	185.0 ⁽²⁾	160.0	172.0 ⁽³⁾
240	BW																
260	B	197.0	279.0 ⁽²⁾	197.0	268.0 ⁽²⁾	194.0	257.0 ⁽²⁾	188.0	249.0 ⁽²⁾	185.0	234.0 ⁽²⁾	185.0	217.0 ⁽²⁾	178.0	190.0 ⁽²⁾	162.0	174.0 ⁽³⁾
260	BV		201.0 ⁽⁷⁾	170.0	198.0 ⁽⁶⁾	169.0	190.0 ⁽⁴⁾	167.0	190.0 ⁽⁴⁾	160.0	186.0 ⁽⁵⁾	162.0	181.0 ⁽⁴⁾	158.0	173.0 ⁽⁴⁾	147.0	161.0 ⁽³⁾
260	BW																
280	B		247.0 ⁽²⁾	171.0	240.0 ⁽²⁾	169.0	230.0 ⁽²⁾	168.0	224.0 ⁽²⁾	162.0	212.0 ⁽²⁾	159.0	201.0 ⁽²⁾	158.0	181.0 ⁽⁵⁾	148.0	166.0 ⁽³⁾
280	BV		177.0 ⁽¹¹⁾		174.0 ⁽⁹⁾	146.0	170.0 ⁽⁷⁾	146.0	167.0 ⁽⁶⁾	143.0	165.0 ⁽⁵⁾	139.0	162.0 ⁽⁴⁾	135.0	158.0 ⁽⁴⁾	131.0	150.0 ⁽³⁾
280	BW																
300	B		218.0 ⁽³⁾		213.0 ⁽²⁾	146.0	206.0 ⁽²⁾	146.0	201.0 ⁽²⁾	143.0	191.0 ⁽²⁾	138.0	184.0 ⁽²⁾	136.0	168.0 ⁽²⁾	131.0	157.0 ⁽³⁾
300	BV		152.0 ⁽¹¹⁾		155.0 ⁽¹⁰⁾		152.0 ⁽⁷⁾	127.0	150.0 ⁽⁶⁾	125.0	148.0 ⁽⁵⁾	126.0	145.0 ⁽⁴⁾	120.0	142.0 ⁽⁴⁾	115.0	135.0 ⁽³⁾
300	BW																
320	B		190.0 ⁽³⁾		187.0 ⁽²⁾		184.0 ⁽³⁾	127.0	182.0 ⁽²⁾	126.0	174.0 ⁽²⁾	125.0	168.0 ⁽²⁾	120.0	157.0 ⁽²⁾	115.0	145.0 ⁽²⁾
320	BV		124.0 ⁽⁹⁾		136.0 ⁽¹¹⁾		136.0 ⁽⁹⁾		133.0 ⁽⁶⁾	109.0	132.0 ⁽⁵⁾	110.0	130.0 ⁽⁵⁾	107.0	126.0 ⁽⁴⁾	101.0	122.0 ⁽⁴⁾
320	BW																
340	B		172.0 ⁽⁸⁾		169.0 ⁽⁵⁾		166.0 ⁽³⁾		163.0 ⁽²⁾	109.0	159.0 ⁽²⁾	110.0	155.0 ⁽²⁾	107.0	146.0 ⁽²⁾	101.0	135.0 ⁽²⁾
340	BV		96.5 ⁽⁷⁾		109.0 ⁽⁹⁾		123.0 ⁽¹⁰⁾		121.0 ⁽⁹⁾		118.0 ⁽⁶⁾	91.8	116.0 ⁽⁵⁾	91.2	112.0 ⁽⁵⁾	87.8	109.0 ⁽⁴⁾
340	BW																
360	B		145.0 ⁽⁷⁾		153.0 ⁽⁴⁾		149.0 ⁽⁴⁾		147.0 ⁽³⁾		144.0 ⁽²⁾	91.6	141.0 ⁽²⁾	90.9	134.0 ⁽²⁾	87.8	123.0 ⁽²⁾
360	BV				84.6 ⁽⁷⁾		98.5 ⁽⁹⁾		110.0 ⁽¹⁰⁾		106.0 ⁽⁷⁾		102.0 ⁽⁷⁾	77.2	100.0 ⁽⁶⁾	76.3	97.1 ⁽⁵⁾
360	BW																
380	B				130.0 ⁽⁷⁾		134.0 ⁽⁶⁾		131.0 ⁽⁴⁾		129.0 ⁽³⁾		127.0 ⁽²⁾	77.3	122.0 ⁽²⁾	76.8	112.0 ⁽²⁾
380	BV						76.0 ⁽⁷⁾		88.0 ⁽⁹⁾		96.2 ⁽¹⁰⁾		93.4 ⁽⁸⁾		90.8 ⁽⁶⁾	64.0	87.0 ⁽⁵⁾
380	BW																
400	B						118.0 ⁽⁷⁾		117.0 ⁽⁵⁾		115.0 ⁽⁴⁾		113.0 ⁽³⁾		110.0 ⁽²⁾	64.4	100.0 ⁽²⁾
400	BV								66.5 ⁽⁷⁾		77.6 ⁽⁹⁾		86.3 ⁽¹⁰⁾		81.5 ⁽⁸⁾		77.4 ⁽⁴⁾
400	BW																
420	B								103.0 ⁽⁷⁾		103.0 ⁽⁶⁾		101.0 ⁽⁵⁾		98.2 ⁽²⁾		91.0 ⁽⁴⁾
420	BV										59.0 ⁽⁷⁾		68.9 ⁽⁹⁾		73.8 ⁽⁹⁾		68.1 ⁽⁶⁾
420	BW																
440	B										92.0 ⁽⁷⁾		90.3 ⁽⁴⁾		86.9 ⁽³⁾		83.3 ⁽²⁾
440	BV												48.1 ⁽⁷⁾		60.2 ⁽⁹⁾		61.6 ⁽¹⁰⁾
440	BW																
460	B												82.7 ⁽⁶⁾		79.4 ⁽⁴⁾		75.6 ⁽²⁾
460	BV														41.5 ⁽⁷⁾		49.4 ⁽⁹⁾
460	BW																
480	B														71.8 ⁽⁶⁾		66.0 ⁽⁴⁾
480	BV																33.6 ⁽⁷⁾
480	BW																59.4 ⁽⁶⁾

1) 12° 2) 17° 3) 22° 4) 27° 5) 32° 6)

SDWB/SDWBV/SDWBW

S 158

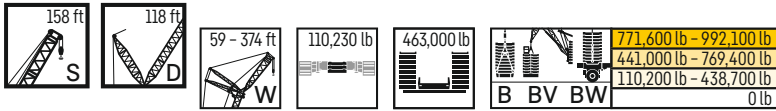

ft	B BV BW	S 158 ft																	
		W 59 ft		W 79 ft		W 98 ft		W 118 ft		W 138 ft		W 158 ft		W 177 ft		W 197 ft		W 217 ft	
		87°/85	WVmax	87°/85	WVmax	87°/85	WVmax	87°/85	WVmax	87°/85	WVmax	87°/85	WVmax	87°/85	WVmax	87°/85	WVmax	87°/85	WVmax
38	B	1432.0*	1432.0*																
	BV	1432.0*	1432.0*																
	BW	1432.0*	1432.0*																
40	B	1432.0*	1432.0*																
	BV	1432.0*	1432.0*																
	BW	1432.0*	1432.0*																
50	B	1428.0	1428.0	1256.0*	1292.0 ⁽¹⁾	1173.0*	1176.0 ⁽¹⁾												
	BV	1429.0	1430.0 ⁽¹⁾	1267.0*	1303.0 ⁽¹⁾	1186.0*	1188.0 ⁽¹⁾												
	BW	1136.0	1279.0 ⁽²⁾	1198.0	1217.0 ⁽²⁾	1170.0	1170.0	1008.0*	1028.0 ⁽¹⁾	902.0*	903.0 ⁽¹⁾								
60	B	1141.0	1425.0 ⁽¹⁾	1206.0	1277.0 ⁽¹⁾	1184.0	1184.0	1019.0*	1040.0 ⁽¹⁾	909.0*	910.0 ⁽¹⁾								
	BV	877.0	1115.0 ⁽¹⁾	932.0	1094.0 ⁽¹⁾	1096.0	1096.0	1012.0	1012.0	904.0	904.0	787.0*	798.0 ⁽¹⁾	703.0*	704.0 ⁽¹⁾				
	BW	878.0	1345.0 ⁽¹⁾	932.0	1248.0 ⁽¹⁾	1120.0	1140.0 ⁽¹⁾	1026.0	1040.0 ⁽¹⁾	916.0	916.0	793.0*	806.0 ⁽¹⁾	709.0*	710.0 ⁽¹⁾				
70	B	641.0	973.0 ⁽⁴⁾	749.0	967.0 ⁽²⁾	977.0	980.0 ⁽³⁾	958.0	958.0	883.0	883.0	793.0	793.0	709.0	709.0	620.0*	626.0 ⁽¹⁾	554.0*	554.0*
	BV	646.0	1184.0 ⁽¹⁾	751.0	1167.0 ⁽¹⁾	1010.0	1096.0 ⁽¹⁾	992.0	1038.0 ⁽¹⁾	895.0	898.0 ⁽¹⁾	802.0	805.0 ⁽¹⁾	716.0	716.0	625.0*	632.0 ⁽¹⁾	558.0*	558.0*
	BW		843.0 ⁽⁴⁾	638.0	847.0 ⁽³⁾	872.0	872.0	862.0	862.0	844.0	844.0	772.0	772.0	693.0	693.0	622.0	622.0	554.0	554.0
80	B		1058.0 ⁽¹⁾	639.0	1068.0 ⁽¹⁾	885.0	1030.0 ⁽²⁾	888.0	1013.0 ⁽¹⁾	855.0	882.0 ⁽¹⁾	786.0	800.0 ⁽¹⁾	704.0	709.0 ⁽¹⁾	631.0	631.0	561.0	561.0
	BV		739.0 ⁽¹⁾	511.0	738.0 ⁽³⁾	756.0	779.0 ⁽⁶⁾	756.0	774.0 ⁽⁴⁾	753.0	762.0 ⁽³⁾	732.0	732.0	673.0	673.0	606.0	607.0 ⁽¹⁾	542.0	542.0
	BW		952.0 ⁽²⁾	514.0	968.0 ⁽¹⁾	754.0	943.0 ⁽³⁾	756.0	936.0 ⁽²⁾	756.0	850.0 ⁽¹⁾	742.0	796.0 ⁽¹⁾	687.0	702.0 ⁽¹⁾	617.0	624.0 ⁽¹⁾	551.0	553.0 ⁽¹⁾
90	B		666.0 ⁽⁸⁾		658.0 ⁽³⁾	621.0	693.0 ⁽⁶⁾	657.0	691.0 ⁽⁵⁾	654.0	683.0 ⁽⁴⁾	657.0	669.0 ⁽³⁾	637.0	638.0 ⁽¹⁾	591.0	594.0 ⁽¹⁾	531.0	531.0
	BV		852.0 ⁽²⁾		869.0 ⁽¹⁾	628.0	850.0 ⁽³⁾	659.0	849.0 ⁽²⁾	659.0	807.0 ⁽²⁾	658.0	759.0 ⁽¹⁾	645.0	694.0 ⁽¹⁾	601.0	617.0 ⁽¹⁾	540.0	546.0 ⁽¹⁾
	BW		596.0 ⁽⁸⁾		594.0 ⁽⁶⁾	459.0	628.0 ⁽⁸⁾	591.0	623.0 ⁽⁵⁾	577.0	620.0 ⁽⁴⁾	578.0	606.0 ⁽³⁾	577.0	590.0 ⁽³⁾	561.0	573.0 ⁽¹⁾	518.0	524.0 ⁽¹⁾
100	B		760.0 ⁽³⁾		770.0 ⁽¹⁾	463.0	773.0 ⁽¹⁾	591.0	768.0 ⁽¹⁾	580.0	753.0 ⁽¹⁾	580.0	722.0 ⁽²⁾	579.0	665.0 ⁽²⁾	567.0	603.0 ⁽¹⁾	526.0	540.0 ⁽¹⁾
	BV		526.0 ⁽⁸⁾		537.0 ⁽⁶⁾		569.0 ⁽⁸⁾	521.0	565.0 ⁽⁷⁾	514.0	559.0 ⁽⁵⁾	516.0	555.0 ⁽⁴⁾	514.0	544.0 ⁽⁵⁾	513.0	535.0 ⁽¹⁾	499.0	505.0 ⁽¹⁾
	BW		684.0 ⁽⁵⁾		684.0 ⁽²⁾		709.0 ⁽⁴⁾	521.0	705.0 ⁽²⁾	516.0	697.0 ⁽¹⁾	515.0	677.0 ⁽²⁾	516.0	635.0 ⁽²⁾	515.0	586.0 ⁽²⁾	503.0	525.0 ⁽²⁾
110	B				485.0 ⁽⁸⁾		506.0 ⁽⁹⁾	392.0	524.0 ⁽⁸⁾	471.0	516.0 ⁽⁴⁾	464.0	508.0 ⁽⁴⁾	460.0	498.0 ⁽⁵⁾	462.0	497.0 ⁽¹⁾	462.0	479.0 ⁽¹⁾
	BV				625.0 ⁽⁴⁾		653.0 ⁽⁶⁾	396.0	650.0 ⁽³⁾	472.0	645.0 ⁽²⁾	464.0	632.0 ⁽²⁾	461.0	596.0 ⁽¹⁾	462.0	560.0 ⁽²⁾	462.0	517.0 ⁽²⁾
	BW				435.0 ⁽⁹⁾		455.0 ⁽⁸⁾		481.0 ⁽⁹⁾	424.0	474.0 ⁽⁷⁾	428.0	473.0 ⁽⁵⁾	417.0	461.0 ⁽⁴⁾	418.0	459.0 ⁽¹⁾	416.0	453.0 ⁽¹⁾
120	B				543.0 ⁽⁷⁾		600.0 ⁽⁶⁾		597.0 ⁽³⁾	425.0	593.0 ⁽²⁾	427.0	589.0 ⁽²⁾	418.0	563.0 ⁽¹⁾	417.0	529.0 ⁽²⁾	417.0	494.0 ⁽²⁾
	BV				410.0 ⁽⁹⁾		434.0 ⁽¹⁰⁾	333.0	437.0 ⁽⁸⁾	387.0	432.0 ⁽⁶⁾	379.0	428.0 ⁽⁵⁾	380.0	428.0 ⁽⁵⁾	380.0	425.0 ⁽⁴⁾	378.0	427.0 ⁽¹⁾
	BW				550.0 ⁽⁷⁾		546.0 ⁽⁴⁾	338.0	546.0 ⁽³⁾	388.0	547.0 ⁽²⁾	381.0	531.0 ⁽¹⁾	379.0	498.0 ⁽²⁾	379.0	498.0 ⁽²⁾	379.0	469.0 ⁽²⁾
130	B				367.0 ⁽¹⁰⁾		393.0 ⁽¹⁰⁾		401.0 ⁽¹⁰⁾	353.0	396.0 ⁽⁷⁾	353.0	393.0 ⁽⁶⁾	347.0	391.0 ⁽⁴⁾	346.0	391.0 ⁽⁴⁾	346.0	401.0 ⁽¹⁾
	BV				503.0 ⁽⁷⁾		499.0 ⁽⁵⁾		501.0 ⁽³⁾	352.0	504.0 ⁽²⁾	353.0	498.0 ⁽¹⁾	348.0	471.0 ⁽²⁾	348.0	471.0 ⁽²⁾	346.0	445.0 ⁽²⁾
	BW				326.0 ⁽⁵⁾		358.0 ⁽¹⁰⁾		366.0 ⁽¹¹⁾	287.0	370.0 ⁽⁸⁾	325.0	363.0 ⁽⁶⁾	325.0	361.0 ⁽⁵⁾	319.0	361.0 ⁽⁵⁾	319.0	374.0 ⁽¹⁾
140	B				455.0 ⁽⁷⁾		462.0 ⁽⁷⁾		463.0 ⁽⁴⁾	287.0	462.0 ⁽³⁾	325.0	466.0 ⁽¹⁾	326.0	445.0 ⁽²⁾	319.0	445.0 ⁽²⁾	319.0	424.0 ⁽²⁾
	BV				291.0 ⁽⁵⁾		323.0 ⁽¹⁰⁾		333.0 ⁽¹⁰⁾		342.0 ⁽⁹⁾	296.0	337.0 ⁽⁸⁾	299.0	335.0 ⁽⁵⁾	298.0	335.0 ⁽⁵⁾	298.0	348.0 ⁽¹⁾
	BW				411.0 ⁽⁶⁾		434.0 ⁽⁸⁾		431.0 ⁽⁵⁾		430.0 ⁽³⁾	297.0	433.0 ⁽¹⁾	300.0	418.0 ⁽²⁾	298.0	418.0 ⁽²⁾	298.0	403.0 ⁽²⁾
150	B				286.0 ⁽⁸⁾		304.0 ⁽⁷⁾		304.0 ⁽⁷⁾		321.0 ⁽¹⁰⁾	243.0	317.0 ⁽⁸⁾	275.0	313.0 ⁽⁶⁾	276.0	313.0 ⁽⁶⁾	276.0	322.0 ⁽¹⁾
	BV						399.0 ⁽⁸⁾		407.0 ⁽⁴⁾		399.0 ⁽³⁾	242.0	400.0 ⁽¹⁾	276.0	391.0 ⁽²⁾	276.0	391.0 ⁽²⁾	276.0	383.0 ⁽²⁾
	BW						249.0 ⁽⁷⁾		249.0 ⁽⁷⁾		271.0 ⁽¹⁰⁾		278.0 ⁽⁹⁾	197.0	273.0 ⁽⁶⁾	236.0	273.0 ⁽⁶⁾	236.0	269.0 ⁽¹⁾
160	B						347.0 ⁽⁸⁾		347.0 ⁽⁸⁾		353.0 ⁽⁶⁾		348.0 ⁽⁴⁾	197.0	346.0 ⁽³⁾	235.0	346.0 ⁽³⁾	235.0	342.0 ⁽²⁾
	BV										216.0 ⁽⁹⁾		238.0 ⁽¹¹⁾		245.0 ⁽¹⁰⁾	167.0	245.0 ⁽¹⁰⁾	167.0	241.0 ⁽⁸⁾
	BW										309.0 ⁽⁹⁾		304.0 ⁽⁵⁾		305.0 ⁽⁴⁾	167.0	305.0 ⁽⁴⁾	167.0	300.0 ⁽²⁾
170	B										177.0 ⁽⁷⁾		193.0 ⁽⁹⁾		213.0 ⁽¹¹⁾		213.0 ⁽¹¹⁾		217.0 ⁽¹⁰⁾
	BV										248.0 ⁽⁷⁾		266.0 ⁽⁹⁾		265.0 ⁽⁵⁾		265.0 ⁽⁵⁾		264.0 ⁽³⁾
	BW										134.0 ⁽⁷⁾		146.0 ⁽⁶⁾		173.0 ⁽⁹⁾		173.0 ⁽⁹⁾		183.0 ⁽¹¹⁾
180	B										206.0 ⁽⁷⁾		225.0 ⁽⁷⁾		235.0 ⁽⁷⁾		235.0 ⁽⁷⁾		232.0 ⁽⁴⁾
	BV												120.0 ⁽⁷⁾		132.0 ⁽⁷⁾		132.0 ⁽⁷⁾		149.0 ⁽⁹⁾
	BW												186.0 ⁽⁷⁾		203.0 ⁽⁷⁾		203.0 ⁽⁷⁾		207.0 ⁽⁷⁾
190	B																		118.0 ⁽⁷⁾
	BV																		181.0 ⁽⁷⁾
	BW																		

1) 12° 2) 17° 3) 22° 4) 27° 5) 32° 6) 37° 7) 42° 8) 47° 9) 52° 10) 57° 11) 62°

SDWB/SDWBV/SDWBW

S 158

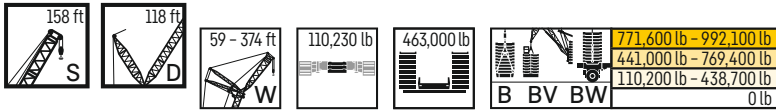

ft	B BV BW	S 158 ft															
		W 236 ft		W 256 ft		W 276 ft		W 295 ft		W 315 ft		W 335 ft		W 354 ft		W 374 ft	
		87°/85	WVmax	87°/85	WVmax	87°/85	WVmax	87°/85	WVmax	87°/85	WVmax	87°/85	WVmax	87°/85	WVmax	87°/85	WVmax
90	BV	487.0*	489.0 ⁽¹⁾	432.0*	432.0*												
	BW	491.0*	494.0 ⁽¹⁾	436.0*	436.0*												
	B	485.0	485.0	430.0	430.0												
100	BV																
	BW	491.0	491.0	435.0	435.0	382.0*	384.0 ⁽¹⁾	339.0*	339.0*	300.0*	300.0*						
	B	476.0	476.0	423.0	423	377.0	377	331.0*	334.0 ⁽¹⁾	295.0*	297.0 ⁽¹⁾	261.0*	261.0*	229.0*	229.0*		
110	BV																
	BW	483.0	486.0 ⁽¹⁾	428.0	428	381.0	381	333.0*	336.0 ⁽¹⁾	296.0*	297.0 ⁽¹⁾	262.0*	262.0*	230.0*	230.0*		
	B	467.0	467.0	416.0	416.0	372.0	372.0	329.0	329	294.0	294.0	256.0*	258.0 ⁽¹⁾	224.0*	225.0 ⁽¹⁾	201.0*	201.0*
120	BV																
	BW	474.0	480.0 ⁽¹⁾	421.0	421.0	376.0	376.0	332.0	332	294.0	294.0	257.0*	260.0 ⁽¹⁾	225.0*	226.0 ⁽¹⁾	200.0*	200.0*
	B	457.0	457.0	408.0	408.0	366.0	366.0	323.0	323.0	289.0	289	255.0	255	222.0	222.0	196.0*	198.0 ⁽¹⁾
130	BV																
	BW	464.0	474.0 ⁽¹⁾	413.0	415.0 ⁽²⁾	370.0	370.0	326.0	326.0	290.0	290	256.0	256	223.0	223.0	196.0*	197.0 ⁽¹⁾
	B	446.0	446.0	400.0	401.0 ⁽²⁾	359.0	361.0 ⁽²⁾	316.0	316.0	285.0	285.0	250.0	250.0	218.0	218	195.0	195
140	BV																
	BW	450.0	463.0 ⁽²⁾	406.0	410.0 ⁽²⁾	364.0	366.0 ⁽²⁾	319.0	319.0	287.0	287.0	252.0	252.0	219.0	219	195.0	195
	B	416.0	433.0 ⁽²⁾	390.0	394.0 ⁽²⁾	353.0	356.0 ⁽²⁾	309.0	312.0 ⁽²⁾	281.0	282.0 ⁽²⁾	247.0	247.0	214.0	214.0	192.0	192
150	BV																
	BW	417.0	458.0 ⁽²⁾	396.0	406.0 ⁽²⁾	357.0	362.0 ⁽²⁾	312.0	315.0 ⁽²⁾	283.0	283.0	249.0	249.0	215.0	215.0	192.0	192
	B	378.0	400.0 ⁽²⁾	369.0	385.0 ⁽²⁾	345.0	352.0 ⁽²⁾	302.0	309.0 ⁽²⁾	277.0	279.0 ⁽²⁾	243.0	243.0	209.0	209.0	189.0	189.0
160	BV																
	BW	380.0	439.0 ⁽²⁾	372.0	401.0 ⁽²⁾	349.0	359.0 ⁽²⁾	305.0	312.0 ⁽²⁾	278.0	280.0 ⁽²⁾	245.0	246.0 ⁽²⁾	210.0	210.0	188.0	188.0
	B	345.0	378.0 ⁽³⁾	341.0	361.0 ⁽³⁾	331.0	344.0 ⁽²⁾	295.0	305.0 ⁽²⁾	271.0	276.0 ⁽²⁾	238.0	241.0 ⁽²⁾	204.0	205.0 ⁽²⁾	185.0	185.0
170	BV																
	BW	346.0	421.0 ⁽²⁾	341.0	387.0 ⁽²⁾	334.0	354.0 ⁽²⁾	298.0	308.0 ⁽²⁾	272.0	277.0 ⁽²⁾	240.0	243.0 ⁽²⁾	205.0	207.0 ⁽²⁾	185.0	185.0
	B	316.0	350.0 ⁽⁴⁾	313.0	345.0 ⁽³⁾	313.0	329.0 ⁽³⁾	289.0	299.0 ⁽²⁾	264.0	273.0 ⁽²⁾	232.0	238.0 ⁽²⁾	198.0	202.0 ⁽²⁾	182.0	183.0 ⁽²⁾
180	BV																
	BW	317.0	403.0 ⁽²⁾	313.0	373.0 ⁽²⁾	314.0	345.0 ⁽²⁾	291.0	304.0 ⁽²⁾	264.0	274.0 ⁽²⁾	234.0	240.0 ⁽²⁾	200.0	204.0 ⁽²⁾	182.0	183.0 ⁽²⁾
	B	292.0	328.0 ⁽⁴⁾	287.0	319.0 ⁽³⁾	289.0	320.0 ⁽³⁾	280.0	290.0 ⁽³⁾	255.0	267.0 ⁽²⁾	225.0	235.0 ⁽²⁾	194.0	199.0 ⁽²⁾	179.0	181.0 ⁽²⁾
190	BV																
	BW	292.0	385.0 ⁽²⁾	288.0	360.0 ⁽²⁾	290.0	336.0 ⁽²⁾	281.0	299.0 ⁽²⁾	256.0	270.0 ⁽²⁾	228.0	238.0 ⁽²⁾	196.0	200.0 ⁽²⁾	178.0	181.0 ⁽²⁾
	B	272.0	302.0 ⁽⁴⁾	264.0	298.0 ⁽⁴⁾	266.0	297.0 ⁽³⁾	262.0	285.0 ⁽³⁾	246.0	262.0 ⁽³⁾	218.0	230.0 ⁽²⁾	190.0	196.0 ⁽²⁾	174.0	179.0 ⁽²⁾
200	BV																
	BW	272.0	366.0 ⁽²⁾	266.0	345.0 ⁽²⁾	266.0	327.0 ⁽²⁾	262.0	294.0 ⁽²⁾	246.0	264.0 ⁽²⁾	221.0	234.0 ⁽²⁾	191.0	197.0 ⁽²⁾	174.0	179.0 ⁽²⁾
	B	237.0	265.0 ⁽⁵⁾	232.0	258.0 ⁽⁴⁾	228.0	260.0 ⁽⁴⁾	224.0	251.0 ⁽³⁾	224.0	245.0 ⁽³⁾	205.0	222.0 ⁽³⁾	182.0	189.0 ⁽²⁾	165.0	174.0 ⁽²⁾
220	BV																
	BW	237.0	330.0 ⁽²⁾	232.0	315.0 ⁽²⁾	229.0	302.0 ⁽²⁾	225.0	278.0 ⁽²⁾	221.0	253.0 ⁽²⁾	207.0	225.0 ⁽³⁾	184.0	191.0 ⁽²⁾	165.0	174.0 ⁽²⁾
	B	204.0	236.0 ⁽⁴⁾	203.0	231.0 ⁽³⁾	202.0	228.0 ⁽⁴⁾	193.0	223.0 ⁽⁴⁾	193.0	219.0 ⁽³⁾	188.0	203.0 ⁽⁴⁾	174.0	182.0 ⁽²⁾	155.0	168.0 ⁽²⁾
240	BV																
	BW	204.0	294.0 ⁽²⁾	203.0	284.0 ⁽²⁾	202.0	275.0 ⁽²⁾	194.0	257.0 ⁽²⁾	190.0	237.0 ⁽²⁾	189.0	214.0 ⁽²⁾	176.0	185.0 ⁽²⁾	155.0	168.0 ⁽²⁾
	B		214.0 ⁽⁸⁾	175.0	207.0 ⁽⁶⁾	176.0	206.0 ⁽⁵⁾	172.0	197.0 ⁽⁴⁾	169.0	194.0 ⁽³⁾	166.0	186.0 ⁽⁴⁾	162.0	174.0 ⁽⁴⁾	145.0	160.0 ⁽³⁾
260	BV																
	BW		259.0 ⁽²⁾	175.0	253.0 ⁽²⁾	177.0	248.0 ⁽²⁾	172.0	235.0 ⁽²⁾	166.0	219.0 ⁽²⁾	166.0	202.0 ⁽²⁾	161.0	180.0 ⁽³⁾	144.0	162.0 ⁽³⁾
	B		186.0 ⁽⁹⁾		182.0 ⁽⁸⁾	152.0	180.0 ⁽⁵⁾	151.0	174.0 ⁽⁴⁾	150.0	173.0 ⁽⁵⁾	142.0	167.0 ⁽⁴⁾	141.0	162.0 ⁽⁴⁾	135.0	153.0 ⁽³⁾
280	BV																
	BW		230.0 ⁽³⁾		221.0 ⁽³⁾	153.0	221.0 ⁽²⁾	150.0	214.0 ⁽²⁾	147.0	201.0 ⁽²⁾	144.0	190.0 ⁽²⁾	140.0	171.0 ⁽³⁾	134.0	157.0 ⁽³⁾
	B		161.0 ⁽¹¹⁾		163.0 ⁽⁹⁾		161.0 ⁽⁸⁾	131.0	157.0 ⁽⁴⁾	132.0	156.0 ⁽⁵⁾	129.0	150.0 ⁽⁴⁾	123.0	148.0 ⁽⁴⁾	122.0	141.0 ⁽⁴⁾
300	BV																
	BW		201.0 ⁽³⁾		195.0 ⁽⁴⁾		195.0 ⁽³⁾	131.0	192.0 ⁽²⁾	130.0	184.0 ⁽²⁾	129.0	178.0 ⁽²⁾	124.0	161.0 ⁽²⁾	119.0	147.0 ⁽³⁾
	B		132.0 ⁽⁹⁾		142.0 ⁽¹¹⁾		144.0 ⁽⁹⁾		139.0 ⁽⁴⁾	114.0	138.0 ⁽⁵⁾	113.0	134.0 ⁽⁵⁾	110.0	132.0 ⁽⁴⁾	106.0	129.0 ⁽⁴⁾
320	BV																
	BW		179.0 ⁽⁸⁾		175.0 ⁽⁴⁾		174.0 ⁽³⁾		170.0 ⁽²⁾	113.0	167.0 ⁽²⁾	114.0	164.0 ⁽³⁾	111.0	152.0 ⁽²⁾	104.0	137.0 ⁽²⁾
	B		105.0 ⁽⁷⁾		118.0 ⁽⁹⁾		127.0 ⁽⁹⁾		125.0 ⁽⁹⁾		123.0 ⁽⁶⁾	95.3	119.0 ⁽⁶⁾	93.7	117.0 ⁽⁵⁾	93.4	115.0 ⁽⁵⁾
340	BV																
	BW		157.0 ⁽⁷⁾		158.0 ⁽⁵⁾		156.0 ⁽⁵⁾		153.0 ⁽³⁾		150.0 ⁽²⁾	95.2	149.0 ⁽²⁾	94.0	141.0 ⁽²⁾	90.9	128.0 ⁽²⁾
	B				91.6 ⁽⁷⁾		107.0 ⁽⁹⁾		113.0 ⁽¹¹⁾		111.0 ⁽⁹⁾		107.0 ⁽⁷⁾	80.9	104.0 ⁽⁶⁾	81.7	103.0 ⁽⁵⁾
360	BV																
	BW				141.0 ⁽⁷⁾		143.0 ⁽⁶⁾		140.0 ⁽⁴⁾		137.0 ⁽³⁾		134.0 ⁽²⁾	80.8	130.0 ⁽²⁾	78.9	118.0 ⁽²⁾
	B						82.2 ⁽⁷⁾		95.3 ⁽⁹⁾		99.9 ⁽¹⁰⁾		97.0 ⁽⁸⁾		93.7 ⁽⁴⁾	69.2	91.7 ⁽⁵⁾
380	BV																
	BW						128.0 ⁽⁷⁾		127.0 ⁽⁵⁾		124.0 ⁽⁴⁾		122.0 ⁽³⁾		119.0 ⁽²⁾	66.9	108.0 ⁽²⁾
	B								72.3 ⁽⁷⁾		84.3 ⁽⁹⁾		88.6 ⁽⁹⁾		85.1 ⁽⁷⁾		82.1 ⁽⁴⁾
400	BV																
	BW								111.0 ⁽⁷⁾		110.0 ⁽⁵⁾		108.0 ⁽³⁾		106.0 ⁽²⁾		97.9 ⁽²⁾
	B										63.0 ⁽⁷⁾		74.5 ⁽⁹⁾		78.5 ⁽⁹⁾		74.3 ⁽⁷⁾
420	BV																
	BW										97.6 ⁽⁷⁾		95.5 ⁽⁴⁾		91.9 ⁽²⁾		88.0 ⁽²⁾
	B												54.5 ⁽⁷⁾		66.1 ⁽⁹⁾		68.8 ⁽⁹⁾
440	BV																
	BW												84.3 ⁽⁶⁾		82.2 ⁽⁴⁾		78.8 ⁽³⁾
	B														47.3 ⁽⁷⁾		55.6 ⁽⁹⁾
460	BV																
	BW														74.4 ⁽⁵⁾		70.8 ⁽³⁾
	B																37.8 ⁽⁷⁾
480	BV																
	BW																64.2 ⁽⁵⁾

1) 12° 2) 17° 3) 22° 4) 27° 5) 32° 6) 37° 7) 42° 8) 47° 9) 52° 10) 57° 11) 62°

SDWB/SDWBV/SDWBW

S 177

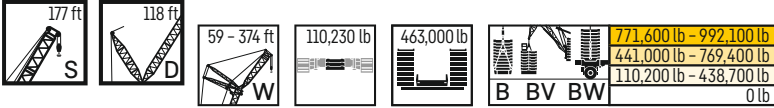

ft	B BV BW	S 177 ft																	
		W 59 ft		W 79 ft		W 98 ft		W 118 ft		W 138 ft		W 158 ft		W 177 ft		W 197 ft		W 217 ft	
		87°/85	WVmax	87°/85	WVmax	87°/85	WVmax	87°/85	WVmax	87°/85	WVmax	87°/85	WVmax	87°/85	WVmax	87°/85	WVmax	87°/85	WVmax
40	BV	1418.0*	1418.0*																
	BW	1426.0*	1426.0*																
50	BV	1394.0	1394.0	1182.0*	1208.0 ⁽¹⁾	1088.0*	1088.0*												
	BW	1415.0	1419.0 ⁽¹⁾	1193.0*	1221.0 ⁽¹⁾	1096.0*	1096.0*												
60	BV	1199.0	1254.0 ⁽²⁾	1174.0	1174.0	1088.0	1088.0	936.0*	950.0 ⁽¹⁾	836.0*	836.0*								
	BW	1199.0	1375.0 ⁽¹⁾	1191.0	1215.0 ⁽¹⁾	1102.0	1103.0 ⁽¹⁾	942.0*	959.0 ⁽¹⁾	842.0*	842.0*								
70	BV	910.0	1101.0 ⁽³⁾	1009.0	1065.0 ⁽²⁾	1048.0	1048.0	941.0	941.0	840.0	840.0	730.0*	739.0 ⁽¹⁾	654.0*	654.0*				
	BW	912.0	1319.0 ⁽¹⁾	1010.0	1206.0 ⁽¹⁾	1069.0	1082.0 ⁽¹⁾	954.0	963.0 ⁽¹⁾	851.0	851.0	736.0*	745.0 ⁽¹⁾	658.0*	658.0*				
80	BV	674.0	968.0 ⁽²⁾	806.0	957.0 ⁽¹⁾	956.0	958.0 ⁽³⁾	912.0	912.0	820.0	820.0	738.0	738.0	660.0	660.0	577.0*	582.0 ⁽¹⁾	516.0*	516.0*
	BW	677.0	1173.0 ⁽²⁾	807.0	1165.0 ⁽¹⁾	991.0	1061.0 ⁽¹⁾	929.0	964.0 ⁽¹⁾	832.0	843.0 ⁽¹⁾	746.0	748.0 ⁽¹⁾	666.0	666.0	581.0*	586.0 ⁽¹⁾	519.0*	519.0*
90	BV		858.0 ⁽⁵⁾	682.0	851.0 ⁽³⁾	857.0	861.0 ⁽⁴⁾	844.0	844.0	793.0	793.0	716.0	716.0	644.0	647.0 ⁽¹⁾	580.0	580.0	504.0*	512.0 ⁽¹⁾
	BW		1038.0 ⁽²⁾	679.0	1073.0 ⁽¹⁾	887.0	1019.0 ⁽²⁾	880.0	964.0 ⁽¹⁾	812.0	838.0 ⁽¹⁾	732.0	744.0 ⁽¹⁾	654.0	659.0 ⁽¹⁾	588.0	588.0	509.0*	518.0 ⁽¹⁾
100	BV		759.0 ⁽⁵⁾	531.0	761.0 ⁽⁴⁾	772.0	775.0 ⁽⁶⁾	764.0	767.0 ⁽⁴⁾	751.0	751.0	695.0	698.0 ⁽¹⁾	628.0	637.0 ⁽¹⁾	566.0	572.0 ⁽¹⁾	506.0	507.0 ⁽¹⁾
	BW		942.0 ⁽¹⁾	535.0	981.0 ⁽¹⁾	781.0	931.0 ⁽²⁾	781.0	916.0 ⁽²⁾	767.0	826.0 ⁽¹⁾	711.0	741.0 ⁽¹⁾	639.0	654.0 ⁽¹⁾	576.0	582.0 ⁽¹⁾	512.0	515.0 ⁽¹⁾
110	BV		678.0 ⁽⁶⁾		677.0 ⁽⁵⁾	653.0	700.0 ⁽⁷⁾	679.0	697.0 ⁽⁵⁾	677.0	688.0 ⁽⁴⁾	662.0	662.0	610.0	627.0 ⁽¹⁾	552.0	564.0 ⁽²⁾	494.0	501.0 ⁽¹⁾
	BW		851.0 ⁽²⁾		889.0 ⁽¹⁾	662.0	847.0 ⁽⁴⁾	677.0	837.0 ⁽²⁾	682.0	795.0 ⁽²⁾	672.0	722.0 ⁽¹⁾	621.0	649.0 ⁽¹⁾	563.0	577.0 ⁽¹⁾	502.0	510.0 ⁽¹⁾
120	BV		608.0 ⁽⁸⁾		610.0 ⁽⁴⁾	497.0	632.0 ⁽⁷⁾	613.0	630.0 ⁽⁵⁾	598.0	626.0 ⁽⁴⁾	598.0	611.0 ⁽⁴⁾	582.0	585.0 ⁽¹⁾	537.0	556.0 ⁽¹⁾	483.0	495.0 ⁽¹⁾
	BW		769.0 ⁽³⁾		797.0 ⁽¹⁾	501.0	769.0 ⁽⁵⁾	607.0	764.0 ⁽³⁾	599.0	741.0 ⁽²⁾	600.0	709.0 ⁽²⁾	589.0	633.0 ⁽²⁾	548.0	572.0 ⁽¹⁾	492.0	505.0 ⁽¹⁾
130	BV		542.0 ⁽⁸⁾		557.0 ⁽⁶⁾		577.0 ⁽⁹⁾	540.0	576.0 ⁽⁶⁾	532.0	571.0 ⁽⁵⁾	533.0	565.0 ⁽⁴⁾	531.0	543.0 ⁽³⁾	514.0	523.0 ⁽¹⁾	472.0	485.0 ⁽¹⁾
	BW		693.0 ⁽⁴⁾		705.0 ⁽¹⁾		703.0 ⁽²⁾	538.0	698.0 ⁽¹⁾	533.0	690.0 ⁽¹⁾	533.0	670.0 ⁽¹⁾	533.0	622.0 ⁽²⁾	521.0	560.0 ⁽²⁾	481.0	496.0 ⁽¹⁾
140	BV		479.0 ⁽⁹⁾		505.0 ⁽⁹⁾		521.0 ⁽⁹⁾	426.0	529.0 ⁽⁸⁾	486.0	523.0 ⁽⁵⁾	479.0	520.0 ⁽⁴⁾	475.0	509.0 ⁽⁵⁾	477.0	493.0 ⁽²⁾	452.0	466.0 ⁽²⁾
	BW		627.0 ⁽⁶⁾		638.0 ⁽³⁾		647.0 ⁽⁴⁾	429.0	643.0 ⁽²⁾	487.0	641.0 ⁽¹⁾	479.0	633.0 ⁽¹⁾	477.0	596.0 ⁽²⁾	478.0	551.0 ⁽²⁾	460.0	493.0 ⁽²⁾
150	BV				458.0 ⁽¹⁰⁾		467.0 ⁽⁷⁾		487.0 ⁽⁹⁾	437.0	482.0 ⁽⁴⁾	440.0	477.0 ⁽⁵⁾	431.0	469.0 ⁽⁴⁾	432.0	460.0 ⁽⁵⁾	425.0	443.0 ⁽²⁾
	BW				579.0 ⁽⁴⁾		600.0 ⁽⁸⁾		596.0 ⁽⁴⁾	438.0	593.0 ⁽²⁾	441.0	590.0 ⁽¹⁾	430.0	570.0 ⁽²⁾	433.0	533.0 ⁽²⁾	427.0	484.0 ⁽²⁾
160	BV				412.0 ⁽¹⁰⁾		426.0 ⁽¹⁰⁾		450.0 ⁽¹⁰⁾	365.0	454.0 ⁽⁸⁾	399.0	447.0 ⁽⁶⁾	392.0	437.0 ⁽⁵⁾	393.0	431.0 ⁽⁴⁾	389.0	422.0 ⁽³⁾
	BW				539.0 ⁽⁷⁾		556.0 ⁽⁸⁾		554.0 ⁽⁵⁾	371.0	551.0 ⁽³⁾	399.0	549.0 ⁽²⁾	391.0	540.0 ⁽²⁾	392.0	515.0 ⁽²⁾	388.0	471.0 ⁽²⁾
170	BV						387.0 ⁽¹⁰⁾		409.0 ⁽¹¹⁾		418.0 ⁽⁹⁾	362.0	413.0 ⁽⁷⁾	364.0	406.0 ⁽⁵⁾	358.0	402.0 ⁽⁴⁾	354.0	391.0 ⁽¹⁾
	BW						511.0 ⁽⁸⁾		514.0 ⁽⁶⁾		512.0 ⁽⁴⁾	363.0	510.0 ⁽⁵⁾	363.0	506.0 ⁽²⁾	359.0	492.0 ⁽²⁾	355.0	458.0 ⁽²⁾
180	BV						348.0 ⁽¹⁰⁾		373.0 ⁽¹⁰⁾		381.0 ⁽¹⁰⁾	309.0	383.0 ⁽⁸⁾	335.0	378.0 ⁽⁶⁾	337.0	372.0 ⁽⁵⁾	325.0	368.0 ⁽¹⁾
	BW						468.0 ⁽⁹⁾		476.0 ⁽⁶⁾		475.0 ⁽⁴⁾	309.0	475.0 ⁽⁵⁾	335.0	472.0 ⁽²⁾	336.0	464.0 ⁽²⁾	325.0	441.0 ⁽²⁾
190	BV						307.0 ⁽⁸⁾		340.0 ⁽¹⁰⁾		348.0 ⁽¹¹⁾		355.0 ⁽⁹⁾	306.0	348.0 ⁽⁶⁾	310.0	346.0 ⁽⁶⁾	303.0	344.0 ⁽¹⁾
	BW						427.0 ⁽⁸⁾		439.0 ⁽⁸⁾		439.0 ⁽⁴⁾		440.0 ⁽⁵⁾	306.0	437.0 ⁽²⁾	310.0	436.0 ⁽²⁾	303.0	419.0 ⁽²⁾
200	BV						274.0 ⁽⁸⁾		307.0 ⁽¹⁰⁾		316.0 ⁽¹⁰⁾		330.0 ⁽¹⁰⁾	259.0	326.0 ⁽⁸⁾	284.0	320.0 ⁽⁶⁾	282.0	321.0 ⁽¹⁾
	BW						388.0 ⁽⁸⁾		409.0 ⁽⁸⁾		408.0 ⁽⁴⁾		410.0 ⁽⁴⁾	260.0	407.0 ⁽⁵⁾	285.0	407.0 ⁽²⁾	283.0	397.0 ⁽²⁾
220	BV								243.0 ⁽⁸⁾		258.0 ⁽¹⁰⁾		282.0 ⁽¹⁰⁾		282.0 ⁽⁷⁾	214.0	280.0 ⁽⁸⁾	240.0	275.0 ⁽⁶⁾
	BW								344.0 ⁽⁸⁾		363.0 ⁽⁹⁾		361.0 ⁽⁵⁾		357.0 ⁽⁴⁾	214.0	356.0 ⁽⁵⁾	241.0	353.0 ⁽²⁾
240	BV										212.0 ⁽⁸⁾		233.0 ⁽¹⁰⁾		247.0 ⁽¹¹⁾		250.0 ⁽¹⁰⁾	182.0	246.0 ⁽⁸⁾
	BW										299.0 ⁽⁸⁾		325.0 ⁽⁹⁾		319.0 ⁽⁵⁾		317.0 ⁽⁴⁾	182.0	310.0 ⁽²⁾
260	BV												184.0 ⁽⁹⁾		208.0 ⁽¹¹⁾		219.0 ⁽¹¹⁾		224.0 ⁽⁹⁾
	BW												270.0 ⁽⁸⁾		286.0 ⁽⁹⁾		279.0 ⁽⁵⁾		277.0 ⁽⁴⁾
280	BV												143.0 ⁽⁷⁾		164.0 ⁽⁹⁾		178.0 ⁽¹¹⁾		194.0 ⁽¹¹⁾
	BW												222.0 ⁽⁷⁾		243.0 ⁽⁹⁾		248.0 ⁽⁸⁾		244.0 ⁽⁴⁾
300	BV														127.0 ⁽⁷⁾		144.0 ⁽⁸⁾		160.0 ⁽¹¹⁾
	BW														195.0 ⁽⁷⁾		216.0 ⁽⁹⁾		213.0 ⁽⁸⁾
320	BV																114.0 ⁽⁷⁾		130.0 ⁽⁹⁾
	BW																175.0 ⁽⁷⁾		185.0 ⁽⁹⁾
340	BV																		102.0 ⁽⁷⁾
	BW																		154.0 ⁽⁷⁾

1) 12° 2) 17° 3) 22° 4) 27° 5) 32° 6) 37° 7) 42° 8) 47° 9) 52° 10) 57° 11) 62°

SDWB/SDWBV/SDWBW

S 177

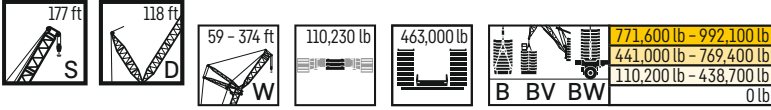

		S 177 ft															
ft	B BV BW	W 236 ft		W 256 ft		W 276 ft		W 295 ft		W 315 ft		W 335 ft		W 354 ft		W 374 ft	
		87°/85	WVmax	87°/85	WVmax	87°/85	WVmax	87°/85	WVmax	87°/85	WVmax	87°/85	WVmax	87°/85	WVmax	87°/85	WVmax
90	BV	452.0*	456.0 ⁽¹⁾	403.0*	403.0*												
	BW	456.0*	460.0 ⁽¹⁾	406.0*	406.0*												
100	B	453.0	453.0	394.0*	399.0 ⁽¹⁾	354.0*	356.0 ⁽¹⁾	317.0*	317.0*								
	BV	458.0	458.0	398.0*	403.0 ⁽¹⁾	357.0*	359.0 ⁽¹⁾	319.0*	319.0*								
	BW	444.0	447.0 ⁽¹⁾	395.0	395.0	354.0	354.0	311.0*	314.0 ⁽¹⁾	278.0*	279.0 ⁽¹⁾	245.0*	245.0*				
110	B	450.0	453.0 ⁽¹⁾	399.0	399	357.0	357.0	313.0*	316.0 ⁽¹⁾	279.0*	280.0 ⁽¹⁾	246.0*	246.0*				
	BV	436.0	442.0 ⁽¹⁾	388.0	388.0	348.0	348.0	311.0	311	277.0	277.0	241.0*	242.0 ⁽¹⁾	213.0*	214.0 ⁽¹⁾	190.0*	190.0*
	BW	442.0	448.0 ⁽¹⁾	393.0	393.0	352.0	352.0	314.0	314	279.0	279.0	242.0*	244.0 ⁽¹⁾	214.0*	214.0*	191.0*	191.0*
120	B	427.0	436.0 ⁽¹⁾	381.0	382.0 ⁽²⁾	343.0	343.0	305.0	305.0	273.0	273	240.0	240	212.0	212.0	187.0*	188.0 ⁽¹⁾
	BV	434.0	444.0 ⁽¹⁾	387.0	388.0 ⁽²⁾	347.0	347.0	309.0	309.0	275.0	275	242.0	242	213.0	213.0	188.0*	189.0 ⁽¹⁾
	BW	417.0	425.0 ⁽²⁾	374.0	379.0 ⁽²⁾	337.0	338.0 ⁽²⁾	299.0	299.0	270.0	270.0	237.0	237.0	207.0	207	186.0	186.0
140	B	425.0	438.0 ⁽²⁾	380.0	385.0 ⁽²⁾	341.0	343.0 ⁽²⁾	302.0	302.0	272.0	272.0	239.0	239.0	209.0	209	187.0	187.0
	BV	404.0	420.0 ⁽²⁾	365.0	375.0 ⁽²⁾	331.0	336.0 ⁽²⁾	294.0	296.0 ⁽²⁾	265.0	265.0	233.0	233.0	202.0	202.0	183.0	183
	BW	409.0	436.0 ⁽²⁾	372.0	383.0 ⁽²⁾	336.0	341.0 ⁽²⁾	297.0	299.0 ⁽²⁾	268.0	268.0	235.0	235.0	205.0	205.0	184.0	184
160	B	384.0	400.0 ⁽²⁾	356.0	372.0 ⁽²⁾	324.0	333.0 ⁽²⁾	288.0	294.0 ⁽²⁾	262.0	262.0	230.0	230.0	198.0	198.0	180.0	180.0
	BV	387.0	428.0 ⁽²⁾	361.0	381.0 ⁽²⁾	329.0	338.0 ⁽²⁾	291.0	297.0 ⁽²⁾	264.0	266.0 ⁽²⁾	232.0	232.0	200.0	200.0	181.0	181.0
	BW	354.0	379.0 ⁽³⁾	343.0	355.0 ⁽²⁾	315.0	330.0 ⁽²⁾	282.0	291.0 ⁽²⁾	256.0	260.0 ⁽²⁾	226.0	228.0 ⁽²⁾	194.0	195.0 ⁽²⁾	177.0	177.0
170	B	354.0	419.0 ⁽²⁾	346.0	375.0 ⁽²⁾	320.0	336.0 ⁽²⁾	285.0	295.0 ⁽²⁾	259.0	264.0 ⁽²⁾	228.0	230.0 ⁽²⁾	196.0	197.0 ⁽²⁾	178.0	178.0
	BV	325.0	357.0 ⁽⁴⁾	319.0	347.0 ⁽³⁾	303.0	320.0 ⁽³⁾	275.0	288.0 ⁽²⁾	248.0	257.0 ⁽²⁾	220.0	225.0 ⁽²⁾	190.0	193.0 ⁽²⁾	174.0	175.0 ⁽²⁾
	BW	325.0	409.0 ⁽²⁾	320.0	367.0 ⁽²⁾	308.0	331.0 ⁽²⁾	278.0	292.0 ⁽²⁾	251.0	262.0 ⁽²⁾	223.0	228.0 ⁽²⁾	192.0	194.0 ⁽²⁾	175.0	176.0 ⁽²⁾
180	B	299.0	339.0 ⁽⁴⁾	294.0	326.0 ⁽³⁾	289.0	317.0 ⁽³⁾	268.0	281.0 ⁽³⁾	241.0	254.0 ⁽²⁾	214.0	223.0 ⁽²⁾	186.0	190.0 ⁽²⁾	171.0	173.0 ⁽²⁾
	BV	299.0	396.0 ⁽²⁾	294.0	360.0 ⁽²⁾	291.0	325.0 ⁽²⁾	271.0	289.0 ⁽²⁾	244.0	259.0 ⁽²⁾	216.0	226.0 ⁽²⁾	188.0	192.0 ⁽²⁾	172.0	175.0 ⁽²⁾
	BW	277.0	314.0 ⁽⁴⁾	272.0	307.0 ⁽⁴⁾	273.0	300.0 ⁽³⁾	258.0	279.0 ⁽³⁾	233.0	248.0 ⁽³⁾	207.0	220.0 ⁽²⁾	183.0	188.0 ⁽²⁾	167.0	171.0 ⁽²⁾
200	B	277.0	377.0 ⁽²⁾	271.0	351.0 ⁽²⁾	272.0	320.0 ⁽²⁾	260.0	285.0 ⁽²⁾	236.0	255.0 ⁽²⁾	209.0	223.0 ⁽²⁾	184.0	190.0 ⁽²⁾	168.0	173.0 ⁽²⁾
	BV	242.0	273.0 ⁽⁵⁾	236.0	267.0 ⁽⁴⁾	234.0	267.0 ⁽⁴⁾	230.0	254.0 ⁽³⁾	218.0	239.0 ⁽³⁾	193.0	211.0 ⁽³⁾	175.0	183.0 ⁽²⁾	157.0	167.0 ⁽²⁾
	BW	241.0	339.0 ⁽²⁾	237.0	323.0 ⁽²⁾	234.0	302.0 ⁽²⁾	230.0	277.0 ⁽²⁾	221.0	247.0 ⁽²⁾	195.0	215.0 ⁽²⁾	177.0	185.0 ⁽²⁾	158.0	169.0 ⁽²⁾
220	B	209.0	243.0 ⁽⁶⁾	207.0	238.0 ⁽⁵⁾	204.0	234.0 ⁽⁴⁾	197.0	229.0 ⁽⁴⁾	198.0	222.0 ⁽⁴⁾	182.0	200.0 ⁽²⁾	166.0	178.0 ⁽²⁾	146.0	161.0 ⁽²⁾
	BV	208.0	301.0 ⁽²⁾	207.0	295.0 ⁽²⁾	206.0	280.0 ⁽²⁾	198.0	259.0 ⁽²⁾	199.0	235.0 ⁽²⁾	184.0	208.0 ⁽³⁾	168.0	180.0 ⁽²⁾	148.0	163.0 ⁽²⁾
	BW	155.0	220.0 ⁽⁷⁾	179.0	214.0 ⁽⁶⁾	180.0	212.0 ⁽⁵⁾	174.0	202.0 ⁽⁴⁾	173.0	197.0 ⁽³⁾	167.0	186.0 ⁽⁴⁾	155.0	171.0 ⁽³⁾	138.0	155.0 ⁽²⁾
260	B	155.0	272.0 ⁽³⁾	179.0	267.0 ⁽²⁾	180.0	258.0 ⁽²⁾	175.0	242.0 ⁽²⁾	173.0	222.0 ⁽²⁾	169.0	201.0 ⁽³⁾	157.0	175.0 ⁽³⁾	139.0	158.0 ⁽²⁾
	BV		195.0 ⁽⁹⁾	133.0	187.0 ⁽⁶⁾	155.0	186.0 ⁽⁵⁾	154.0	179.0 ⁽⁴⁾	153.0	177.0 ⁽⁵⁾	147.0	170.0 ⁽⁴⁾	142.0	162.0 ⁽³⁾	130.0	149.0 ⁽³⁾
	BW		238.0 ⁽³⁾	132.0	234.0 ⁽³⁾	156.0	235.0 ⁽²⁾	154.0	224.0 ⁽²⁾	154.0	209.0 ⁽²⁾	148.0	189.0 ⁽³⁾	142.0	169.0 ⁽³⁾	131.0	152.0 ⁽³⁾
300	B		168.0 ⁽¹¹⁾		168.0 ⁽¹⁰⁾	115.0	167.0 ⁽⁸⁾	134.0	163.0 ⁽⁶⁾	135.0	159.0 ⁽⁵⁾	132.0	154.0 ⁽⁵⁾	125.0	149.0 ⁽⁴⁾	122.0	140.0 ⁽⁴⁾
	BV																
	BW		209.0 ⁽⁵⁾		206.0 ⁽³⁾	116.0	206.0 ⁽²⁾	134.0	203.0 ⁽⁴⁾	135.0	196.0 ⁽²⁾	132.0	179.0 ⁽⁴⁾	125.0	160.0 ⁽²⁾	123.0	145.0 ⁽³⁾
320	B		142.0 ⁽¹¹⁾		148.0 ⁽¹¹⁾		150.0 ⁽⁹⁾	94.5	144.0 ⁽⁷⁾	119.0	143.0 ⁽⁶⁾	116.0	139.0 ⁽³⁾	114.0	135.0 ⁽⁵⁾	110.0	131.0 ⁽⁴⁾
	BV																
	BW		186.0 ⁽⁸⁾		181.0 ⁽⁴⁾		181.0 ⁽³⁾	94.6	179.0 ⁽²⁾	119.0	177.0 ⁽²⁾	116.0	168.0 ⁽²⁾	114.0	154.0 ⁽²⁾	111.0	138.0 ⁽³⁾
340	B		114.0 ⁽⁸⁾		128.0 ⁽¹¹⁾		132.0 ⁽⁹⁾		129.0 ⁽⁸⁾	81.4	127.0 ⁽⁸⁾	98.0	122.0 ⁽⁴⁾	96.5	121.0 ⁽⁵⁾	96.1	119.0 ⁽⁵⁾
	BV																
	BW		167.0 ⁽⁹⁾		163.0 ⁽⁸⁾		161.0 ⁽⁵⁾		159.0 ⁽³⁾	81.6	158.0 ⁽³⁾	98.4	153.0 ⁽²⁾	96.5	144.0 ⁽²⁾	99.2	131.0 ⁽³⁾
360	B				102.0 ⁽⁹⁾		116.0 ⁽¹¹⁾		116.0 ⁽⁹⁾		114.0 ⁽⁹⁾	65.8	110.0 ⁽⁸⁾	83.8	108.0 ⁽⁶⁾	84.3	107.0 ⁽⁵⁾
	BV																
	BW		140.0 ⁽⁷⁾		148.0 ⁽⁹⁾		146.0 ⁽⁶⁾		144.0 ⁽⁴⁾		143.0 ⁽³⁾	66.1	138.0 ⁽³⁾	83.9	133.0 ⁽²⁾	84.2	123.0 ⁽³⁾
380	B				78.2 ⁽⁷⁾		91.6 ⁽⁹⁾		102.0 ⁽¹¹⁾		102.0 ⁽⁹⁾		99.4 ⁽⁸⁾		96.5 ⁽⁶⁾	72.1	94.8 ⁽⁶⁾
	BV																
	BW				126.0 ⁽⁷⁾		134.0 ⁽⁷⁾		131.0 ⁽⁵⁾		129.0 ⁽⁴⁾		126.0 ⁽³⁾		121.0 ⁽²⁾	72.0	114.0 ⁽³⁾
400	B						70.0 ⁽⁷⁾		80.8 ⁽⁹⁾		92.2 ⁽¹¹⁾		89.8 ⁽⁹⁾		86.7 ⁽⁷⁾		85.0 ⁽⁴⁾
	BV																
	BW						113.0 ⁽⁷⁾		121.0 ⁽⁷⁾		119.0 ⁽⁵⁾		115.0 ⁽⁴⁾		111.0 ⁽³⁾		105.0 ⁽³⁾
420	B								59.4 ⁽⁶⁾		71.9 ⁽⁹⁾		82.3 ⁽¹¹⁾		79.1 ⁽⁸⁾		75.6 ⁽⁷⁾
	BV																
	BW								101.0 ⁽²⁾		107.0 ⁽⁸⁾		103.0 ⁽⁴⁾		100.0 ⁽³⁾		95.6 ⁽³⁾
440	B										51.9 ⁽⁷⁾		62.9 ⁽⁹⁾		72.4 ⁽¹¹⁾		68.2 ⁽⁵⁾
	BV																
	BW										90.3 ⁽⁷⁾		89.6 ⁽⁸⁾		86.9 ⁽⁴⁾		85.3 ⁽³⁾
460	B												44.2 ⁽⁷⁾		53.3 ⁽⁹⁾		58.3 ⁽⁹⁾
	BV																
	BW												77.9 ⁽⁷⁾		76.9 ⁽⁴⁾		75.6 ⁽⁴⁾
480	B														36.7 ⁽⁷⁾		44.0 ⁽⁹⁾
	BV																
	BW														68.7 ⁽⁷⁾		66.8 ⁽⁵⁾
500	B																28.7 ⁽⁷⁾
	BV																
	BW																59.4 ⁽⁷⁾

1) 12° 2) 17° 3) 22° 4) 27° 5) 32° 6) 37° 7) 42° 8) 47° 9) 52° 10) 57° 11) 62°

SDWB/SDWBV/SDWBW

S 197

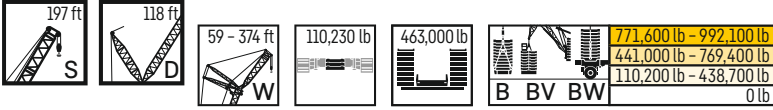

ft	S	S 197 ft																	
		W 59 ft		W 79 ft		W 98 ft		W 118 ft		W 138 ft		W 158 ft		W 177 ft		W 197 ft		W 217 ft	
		87*/85	WVmax	87*/85	WVmax	87*/85	WVmax	87*/85	WVmax	87*/85	WVmax	87*/85	WVmax	87*/85	WVmax	87*/85	WVmax	87*/85	WVmax
50	BV	1270.0	1270.0	1086.0*	1111.0 ⁽¹⁾	996.0*	996.0*												
	BW	1298.0	1298.0	1099.0*	1127.0 ⁽¹⁾	1006.0*	1006.0*												
60	BV	1184.0	1184.0	1088.0	1088.0	1004.0	1004.0	864.0*	875.0 ⁽¹⁾	774.0*	774.0*								
	BW	1210.0	1277.0 ⁽¹⁾	1108.0	1130.0 ⁽¹⁾	1023.0	1023.0	871.0*	884.0 ⁽¹⁾	779.0*	779.0*								
70	BV	951.0	1070.0 ⁽¹⁾	1009.0	1012.0 ⁽¹⁾	954.0	954.0	872.0	872.0	754.0*	775.0 ⁽¹⁾	678.0*	685.0 ⁽¹⁾	606.0*	606.0*				
	BW	954.0	1256.0 ⁽¹⁾	1025.0	1128.0 ⁽¹⁾	978.0	1018.0 ⁽¹⁾	885.0	890.0 ⁽¹⁾	760.0*	783.0 ⁽¹⁾	681.0*	688.0 ⁽¹⁾	610.0*	610.0*				
80	BV	726.0	954.0 ⁽¹⁾	838.0	939.0 ⁽¹⁾	901.0	901.0	836.0	836.0	763.0	763.0	686.0	686.0	594.0*	606.0 ⁽¹⁾	536.0*	538.0 ⁽¹⁾	481.0*	481.0*
	BW	731.0	1158.0 ⁽²⁾	841.0	1121.0 ⁽¹⁾	926.0	1019.0 ⁽¹⁾	856.0	890.0 ⁽¹⁾	773.0	783.0 ⁽¹⁾	692.0	693.0 ⁽¹⁾	599.0*	612.0 ⁽¹⁾	540.0*	543.0 ⁽¹⁾	483.0*	483.0*
90	BV		848.0 ⁽⁴⁾	698.0	840.0 ⁽²⁾	838.0	838.0	788.0	798.0 ⁽¹⁾	732.0	741.0 ⁽¹⁾	667.0	674.0 ⁽¹⁾	598.0	601.0 ⁽¹⁾	538.0	538.0	470.0*	477.0 ⁽¹⁾
	BW		1033.0 ⁽²⁾	698.0	1040.0 ⁽¹⁾	857.0	993.0 ⁽¹⁾	816.0	890.0 ⁽¹⁾	754.0	782.0 ⁽¹⁾	679.0	690.0 ⁽¹⁾	608.0	612.0 ⁽¹⁾	546.0	546.0	474.0*	482.0 ⁽¹⁾
100	BV		760.0 ⁽⁶⁾	568.0	755.0 ⁽⁴⁾	752.0	762.0 ⁽⁵⁾	741.0	741.0	693.0	722.0 ⁽¹⁾	645.0	664.0 ⁽¹⁾	582.0	594.0 ⁽¹⁾	526.0	531.0 ⁽¹⁾	473.0	474.0 ⁽¹⁾
	BW		917.0 ⁽³⁾	569.0	958.0 ⁽¹⁾	764.0	915.0 ⁽²⁾	764.0	866.0 ⁽²⁾	717.0	780.0 ⁽¹⁾	658.0	687.0 ⁽¹⁾	593.0	607.0 ⁽¹⁾	535.0	541.0 ⁽¹⁾	479.0	480.0 ⁽¹⁾
110	BV		678.0 ⁽⁷⁾		683.0 ⁽⁵⁾	662.0	691.0 ⁽⁶⁾	684.0	684.0	655.0	664.0 ⁽¹⁾	614.0	650.0 ⁽¹⁾	565.0	586.0 ⁽¹⁾	513.0	525.0 ⁽¹⁾	462.0	468.0 ⁽¹⁾
	BW		804.0 ⁽⁶⁾		877.0 ⁽¹⁾	667.0	834.0 ⁽⁴⁾	704.0	819.0 ⁽²⁾	675.0	759.0 ⁽²⁾	631.0	680.0 ⁽¹⁾	577.0	603.0 ⁽¹⁾	522.0	536.0 ⁽¹⁾	470.0	476.0 ⁽¹⁾
120	BV		589.0 ⁽¹¹⁾		616.0 ⁽⁶⁾	509.0	625.0 ⁽⁷⁾	630.0	630.0	614.0	614.0	583.0	599.0 ⁽²⁾	541.0	566.0 ⁽¹⁾	499.0	520.0 ⁽¹⁾	453.0	463.0 ⁽¹⁾
	BW		594.0 ⁽¹¹⁾		796.0 ⁽¹⁾	516.0	765.0 ⁽⁵⁾	646.0	755.0 ⁽³⁾	627.0	726.0 ⁽³⁾	597.0	671.0 ⁽²⁾	556.0	591.0 ⁽¹⁾	509.0	532.0 ⁽¹⁾	460.0	472.0 ⁽¹⁾
130	BV				558.0 ⁽⁷⁾		571.0 ⁽⁸⁾	555.0	580.0 ⁽⁸⁾	564.0	569.0 ⁽⁴⁾	552.0	552.0	515.0	541.0 ⁽²⁾	482.0	500.0 ⁽²⁾	441.0	458.0 ⁽¹⁾
	BW				714.0 ⁽¹⁾		698.0 ⁽⁵⁾	560.0	696.0 ⁽⁴⁾	569.0	686.0 ⁽³⁾	560.0	653.0 ⁽³⁾	530.0	590.0 ⁽²⁾	493.0	523.0 ⁽²⁾	449.0	469.0 ⁽¹⁾
140	BV				513.0 ⁽¹⁰⁾		525.0 ⁽⁹⁾	434.0	530.0 ⁽⁸⁾	515.0	525.0 ⁽⁴⁾	510.0	516.0 ⁽⁶⁾	489.0	499.0 ⁽²⁾	461.0	490.0 ⁽²⁾	426.0	447.0 ⁽²⁾
	BW				639.0 ⁽⁴⁾		639.0 ⁽⁶⁾	439.0	642.0 ⁽⁵⁾	517.0	638.0 ⁽⁴⁾	507.0	624.0 ⁽³⁾	500.0	574.0 ⁽³⁾	473.0	521.0 ⁽²⁾	436.0	461.0 ⁽²⁾
150	BV				466.0 ⁽¹⁰⁾		478.0 ⁽⁹⁾		485.0 ⁽⁹⁾	463.0	484.0 ⁽⁷⁾	470.0	482.0 ⁽⁶⁾	457.0	465.0 ⁽⁴⁾	438.0	454.0 ⁽³⁾	410.0	438.0 ⁽²⁾
	BW				583.0 ⁽⁴⁾		592.0 ⁽⁵⁾		589.0 ⁽⁶⁾	462.0	589.0 ⁽⁴⁾	466.0	581.0 ⁽³⁾	457.0	556.0 ⁽³⁾	450.0	511.0 ⁽³⁾	422.0	458.0 ⁽²⁾
160	BV				419.0 ⁽¹⁰⁾		437.0 ⁽¹⁰⁾		448.0 ⁽¹⁰⁾	371.0	449.0 ⁽⁸⁾	424.0	447.0 ⁽⁶⁾	416.0	436.0 ⁽⁴⁾	413.0	427.0 ⁽⁵⁾	394.0	408.0 ⁽⁵⁾
	BW				532.0 ⁽⁵⁾		550.0 ⁽⁸⁾		547.0 ⁽⁵⁾	377.0	544.0 ⁽³⁾	423.0	539.0 ⁽¹⁾	415.0	530.0 ⁽²⁾	416.0	501.0 ⁽²⁾	404.0	453.0 ⁽²⁾
170	BV				373.0 ⁽¹⁰⁾		400.0 ⁽¹⁰⁾		408.0 ⁽¹⁰⁾		419.0 ⁽⁹⁾	375.0	417.0 ⁽⁷⁾	383.0	409.0 ⁽⁵⁾	381.0	406.0 ⁽⁴⁾	372.0	388.0 ⁽³⁾
	BW				494.0 ⁽⁸⁾		509.0 ⁽⁸⁾		512.0 ⁽⁸⁾		509.0 ⁽⁵⁾	372.0	504.0 ⁽³⁾	385.0	499.0 ⁽²⁾	382.0	491.0 ⁽²⁾	378.0	448.0 ⁽²⁾
180	BV						363.0 ⁽¹⁰⁾		373.0 ⁽⁹⁾		389.0 ⁽¹⁰⁾	313.0	390.0 ⁽⁸⁾	352.0	383.0 ⁽⁴⁾	355.0	378.0 ⁽⁵⁾	347.0	369.0 ⁽⁴⁾
	BW						469.0 ⁽⁸⁾		478.0 ⁽⁸⁾		478.0 ⁽⁷⁾	311.0	473.0 ⁽⁴⁾	352.0	468.0 ⁽³⁾	355.0	465.0 ⁽²⁾	350.0	443.0 ⁽²⁾
190	BV						326.0 ⁽¹⁰⁾		340.0 ⁽⁹⁾		358.0 ⁽¹¹⁾		366.0 ⁽⁹⁾	312.0	360.0 ⁽⁷⁾	328.0	358.0 ⁽⁴⁾	324.0	348.0 ⁽⁵⁾
	BW						430.0 ⁽⁹⁾		444.0 ⁽⁸⁾		448.0 ⁽⁷⁾		444.0 ⁽⁵⁾	312.0	439.0 ⁽³⁾	328.0	437.0 ⁽²⁾	324.0	422.0 ⁽²⁾
200	BV								307.0 ⁽¹⁰⁾		327.0 ⁽¹⁰⁾		339.0 ⁽⁹⁾	265.0	338.0 ⁽⁸⁾	294.0	336.0 ⁽⁷⁾	304.0	329.0 ⁽⁶⁾
	BW								411.0 ⁽⁹⁾		419.0 ⁽⁷⁾		416.0 ⁽⁵⁾	265.0	413.0 ⁽⁴⁾	294.0	412.0 ⁽³⁾	304.0	400.0 ⁽³⁾
220	BV								248.0 ⁽⁸⁾		272.0 ⁽¹⁰⁾		291.0 ⁽¹⁰⁾		291.0 ⁽¹⁰⁾	218.0	296.0 ⁽⁸⁾	251.0	290.0 ⁽⁷⁾
	BW								346.0 ⁽⁸⁾		362.0 ⁽⁹⁾		361.0 ⁽⁶⁾		361.0 ⁽⁴⁾	218.0	361.0 ⁽³⁾	251.0	358.0 ⁽³⁾
240	BV								204.0 ⁽⁸⁾		215.0 ⁽⁸⁾		244.0 ⁽¹⁰⁾		252.0 ⁽¹¹⁾		256.0 ⁽⁹⁾	185.0	257.0 ⁽⁸⁾
	BW								286.0 ⁽⁸⁾		309.0 ⁽⁸⁾		318.0 ⁽⁸⁾		316.0 ⁽⁵⁾		317.0 ⁽⁴⁾	185.0	316.0 ⁽³⁾
260	BV										169.0 ⁽⁸⁾		197.0 ⁽⁹⁾		209.0 ⁽⁸⁾		226.0 ⁽¹¹⁾		228.0 ⁽⁹⁾
	BW										257.0 ⁽⁸⁾		277.0 ⁽⁸⁾		283.0 ⁽⁸⁾		281.0 ⁽⁵⁾		279.0 ⁽⁴⁾
280	BV												152.0 ⁽⁹⁾		172.0 ⁽⁸⁾		188.0 ⁽¹¹⁾		201.0 ⁽¹⁰⁾
	BW												234.0 ⁽⁸⁾		251.0 ⁽⁹⁾		255.0 ⁽⁸⁾		251.0 ⁽⁵⁾
300	BV												123.0 ⁽⁷⁾		136.0 ⁽⁹⁾		151.0 ⁽⁹⁾		166.0 ⁽¹⁰⁾
	BW												187.0 ⁽⁷⁾		215.0 ⁽⁹⁾		223.0 ⁽⁹⁾		229.0 ⁽⁸⁾
320	BV																124.0 ⁽⁹⁾		135.0 ⁽⁹⁾
	BW																183.0 ⁽⁹⁾		200.0 ⁽⁹⁾
340	BV																97.0 ⁽⁷⁾		111.0 ⁽⁹⁾
	BW																149.0 ⁽⁷⁾		167.0 ⁽⁹⁾
360	BV																		86.5 ⁽⁷⁾
	BW																		136.0 ⁽⁷⁾

1) 12° 2) 17° 3) 22° 4) 27° 5) 32° 6) 37° 7) 42° 8) 47° 9) 52° 10) 57° 11) 62°

SDWB/SDWBV/SDWBW

S 197

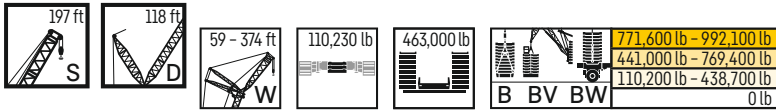

		S 197 ft															
		W 236 ft		W 256 ft		W 276 ft		W 295 ft		W 315 ft		W 335 ft		W 354 ft		W 374 ft	
		87*/85	WVmax	87*/85	WVmax	87*/85	WVmax	87*/85	WVmax	87*/85	WVmax	87*/85	WVmax	87*/85	WVmax	87*/85	WVmax
90	B	422.0*	424.0 ⁽¹⁾	378.0*	378.0*												
	BV	425.0*	427.0 ⁽¹⁾	380.0*	380.0*												
	BW	423.0	423.0	370.0*	374.0 ⁽¹⁾	331.0*	332.0 ⁽¹⁾	297.0*	297.0*								
100	B	427.0	427.0	373.0*	377.0 ⁽¹⁾	333.0*	334.0 ⁽¹⁾	298.0*	298.0*								
	BV	416.0	417.0 ⁽¹⁾	371.0	371.0	331.0	331.0	292.0*	294.0 ⁽¹⁾	260.0*	261.0 ⁽¹⁾	230.0*	230.0*				
	BW	420.0	422.0 ⁽¹⁾	375.0	375.0	334.0	334.0	294.0*	296.0 ⁽¹⁾	261.0*	262.0 ⁽¹⁾	231.0*	231.0*				
110	B	406.0	412.0 ⁽¹⁾	365.0	367.0 ⁽¹⁾	326.0	326.0	292.0	292.0	261.0	261.0	226.0*	228.0 ⁽¹⁾	201.0*	201.0*	179.0*	179.0*
	BV	413.0	418.0 ⁽¹⁾	369.0	372.0 ⁽¹⁾	329.0	330.0 ⁽¹⁾	294.0	294.0	262.0	262.0	228.0*	229.0 ⁽¹⁾	200.0*	201.0 ⁽¹⁾	180.0*	180.0*
	BW	398.0	407.0 ⁽¹⁾	358.0	362.0 ⁽¹⁾	321.0	321.0	288.0	288.0	256.0	256.0	226.0	226.0	197.0*	200.0 ⁽¹⁾	177.0*	178.0 ⁽¹⁾
120	B	405.0	414.0 ⁽¹⁾	363.0	368.0 ⁽¹⁾	325.0	327.0 ⁽¹⁾	291.0	291.0	258.0	258.0	227.0	227.0	196.0*	199.0 ⁽¹⁾	177.0*	178.0 ⁽¹⁾
	BV	389.0	401.0 ⁽¹⁾	351.0	358.0 ⁽¹⁾	316.0	317.0 ⁽²⁾	284.0	284.0	252.0	252.0	223.0	223.0	197.0	197.0	176.0	176.0
	BW	395.0	408.0 ⁽¹⁾	356.0	364.0 ⁽¹⁾	320.0	323.0 ⁽¹⁾	287.0	287.0	254.0	254.0	224.0	224.0	197.0	197.0	177.0	177.0
130	B	379.0	396.0 ⁽²⁾	344.0	353.0 ⁽²⁾	309.0	314.0 ⁽²⁾	280.0	281.0 ⁽²⁾	248.0	248.0	220.0	220.0	194.0	194.0	173.0	173.0
	BV	386.0	406.0 ⁽²⁾	349.0	360.0 ⁽²⁾	315.0	320.0 ⁽¹⁾	283.0	284.0 ⁽²⁾	251.0	251.0	222.0	222.0	193.0	193.0	174.0	174.0
	BW	365.0	387.0 ⁽²⁾	334.0	351.0 ⁽²⁾	303.0	312.0 ⁽²⁾	275.0	279.0 ⁽²⁾	245.0	246.0 ⁽²⁾	217.0	217.0	191.0	191.0	171.0	171.0
140	B	375.0	404.0 ⁽²⁾	341.0	358.0 ⁽²⁾	308.0	318.0 ⁽²⁾	278.0	283.0 ⁽²⁾	247.0	249.0 ⁽²⁾	219.0	219.0	190.0	190.0	172.0	172.0
	BV	351.0	372.0 ⁽³⁾	325.0	342.0 ⁽²⁾	295.0	309.0 ⁽²⁾	270.0	277.0 ⁽²⁾	240.0	244.0 ⁽²⁾	213.0	215.0 ⁽²⁾	187.0	188.0 ⁽²⁾	169.0	169.0
	BW	361.0	400.0 ⁽²⁾	332.0	355.0 ⁽²⁾	300.0	316.0 ⁽²⁾	273.0	281.0 ⁽²⁾	243.0	247.0 ⁽²⁾	216.0	217.0 ⁽²⁾	187.0	187.0	170.0	170.0
150	B	335.0	355.0 ⁽³⁾	314.0	337.0 ⁽³⁾	286.0	302.0 ⁽²⁾	263.0	275.0 ⁽²⁾	234.0	242.0 ⁽²⁾	208.0	213.0 ⁽²⁾	184.0	186.0 ⁽²⁾	166.0	167.0 ⁽²⁾
	BV	341.0	396.0 ⁽²⁾	321.0	351.0 ⁽²⁾	290.0	313.0 ⁽²⁾	266.0	279.0 ⁽²⁾	237.0	245.0 ⁽²⁾	210.0	215.0 ⁽²⁾	183.0	186.0 ⁽²⁾	167.0	168.0 ⁽²⁾
	BW	319.0	341.0 ⁽⁴⁾	302.0	325.0 ⁽³⁾	276.0	298.0 ⁽³⁾	254.0	269.0 ⁽³⁾	228.0	240.0 ⁽²⁾	201.0	211.0 ⁽²⁾	180.0	184.0 ⁽²⁾	162.0	165.0 ⁽²⁾
160	B	318.0	392.0 ⁽²⁾	308.0	347.0 ⁽²⁾	281.0	308.0 ⁽²⁾	258.0	276.0 ⁽²⁾	230.0	244.0 ⁽²⁾	203.0	214.0 ⁽²⁾	180.0	184.0 ⁽²⁾	164.0	166.0 ⁽²⁾
	BV	294.0	319.0 ⁽⁴⁾	288.0	311.0 ⁽⁴⁾	267.0	290.0 ⁽³⁾	246.0	269.0 ⁽³⁾	221.0	236.0 ⁽²⁾	195.0	208.0 ⁽²⁾	176.0	182.0 ⁽²⁾	158.0	163.0 ⁽²⁾
	BW	294.0	376.0 ⁽²⁾	291.0	343.0 ⁽²⁾	271.0	305.0 ⁽³⁾	250.0	273.0 ⁽²⁾	223.0	241.0 ⁽²⁾	197.0	212.0 ⁽²⁾	176.0	182.0 ⁽²⁾	159.0	165.0 ⁽²⁾
170	B	257.0	283.0 ⁽⁵⁾	255.0	279.0 ⁽⁵⁾	245.0	269.0 ⁽⁴⁾	230.0	253.0 ⁽⁴⁾	206.0	228.0 ⁽³⁾	183.0	201.0 ⁽²⁾	169.0	178.0 ⁽²⁾	147.0	152.0 ⁽²⁾
	BV	257.0	343.0 ⁽³⁾	255.0	325.0 ⁽³⁾	247.0	296.0 ⁽³⁾	234.0	266.0 ⁽²⁾	208.0	234.0 ⁽²⁾	185.0	205.0 ⁽²⁾	169.0	178.0 ⁽²⁾	149.0	161.0 ⁽²⁾
	BW	215.0	249.0 ⁽⁶⁾	222.0	248.0 ⁽⁶⁾	221.0	244.0 ⁽⁵⁾	214.0	234.0 ⁽⁴⁾	192.0	218.0 ⁽⁴⁾	172.0	193.0 ⁽²⁾	158.0	173.0 ⁽³⁾	139.0	153.0 ⁽²⁾
180	B	214.0	309.0 ⁽³⁾	223.0	298.0 ⁽³⁾	221.0	282.0 ⁽³⁾	215.0	258.0 ⁽⁴⁾	195.0	228.0 ⁽³⁾	174.0	198.0 ⁽²⁾	158.0	173.0 ⁽²⁾	140.0	155.0 ⁽²⁾
	BV	157.0	225.0 ⁽⁸⁾	184.0	221.0 ⁽⁶⁾	191.0	216.0 ⁽⁵⁾	190.0	211.0 ⁽⁵⁾	180.0	204.0 ⁽⁵⁾	160.0	180.0 ⁽⁴⁾	148.0	168.0 ⁽³⁾	130.0	147.0 ⁽²⁾
	BW	157.0	275.0 ⁽³⁾	184.0	271.0 ⁽³⁾	191.0	260.0 ⁽³⁾	189.0	244.0 ⁽³⁾	182.0	221.0 ⁽³⁾	164.0	192.0 ⁽³⁾	148.0	170.0 ⁽³⁾	132.0	149.0 ⁽²⁾
190	B		200.0 ⁽⁹⁾	135.0	193.0 ⁽⁶⁾	158.0	189.0 ⁽⁵⁾	167.0	187.0 ⁽⁶⁾	166.0	182.0 ⁽⁶⁾	149.0	170.0 ⁽⁵⁾	139.0	162.0 ⁽³⁾	123.0	142.0 ⁽³⁾
	BV		247.0 ⁽⁴⁾	134.0	243.0 ⁽³⁾	158.0	238.0 ⁽³⁾	168.0	228.0 ⁽²⁾	165.0	209.0 ⁽³⁾	152.0	186.0 ⁽³⁾	139.0	166.0 ⁽³⁾	124.0	144.0 ⁽³⁾
	BW		173.0 ⁽⁹⁾		173.0 ⁽⁹⁾	116.0	172.0 ⁽⁸⁾	138.0	168.0 ⁽⁷⁾	144.0	164.0 ⁽⁶⁾	140.0	159.0 ⁽⁶⁾	131.0	149.0 ⁽⁵⁾	115.0	135.0 ⁽⁴⁾
200	B		223.0 ⁽⁶⁾		221.0 ⁽⁴⁾	116.0	217.0 ⁽³⁾	137.0	213.0 ⁽²⁾	144.0	197.0 ⁽³⁾	142.0	178.0 ⁽³⁾	131.0	161.0 ⁽⁴⁾	117.0	140.0 ⁽³⁾
	BV		148.0 ⁽¹¹⁾		154.0 ⁽¹⁰⁾		157.0 ⁽⁹⁾	97.2	153.0 ⁽⁸⁾	119.0	149.0 ⁽⁷⁾	123.0	145.0 ⁽⁶⁾	123.0	139.0 ⁽⁵⁾	108.0	130.0 ⁽⁴⁾
	BW		204.0 ⁽⁸⁾		199.0 ⁽⁵⁾		194.0 ⁽⁴⁾	97.3	192.0 ⁽³⁾	119.0	185.0 ⁽³⁾	124.0	171.0 ⁽³⁾	122.0	153.0 ⁽³⁾	110.0	136.0 ⁽³⁾
210	B		120.0 ⁽⁹⁾		132.0 ⁽¹⁰⁾		138.0 ⁽¹⁰⁾		138.0 ⁽⁹⁾	82.7	137.0 ⁽⁸⁾	98.2	132.0 ⁽⁷⁾	109.0	129.0 ⁽⁶⁾	98.4	123.0 ⁽⁵⁾
	BV		176.0 ⁽⁸⁾		180.0 ⁽⁸⁾		174.0 ⁽⁵⁾		173.0 ⁽⁴⁾	82.6	169.0 ⁽³⁾	98.5	163.0 ⁽³⁾	103.0	147.0 ⁽³⁾	102.0	131.0 ⁽³⁾
	BW		96.1 ⁽⁹⁾		108.0 ⁽⁹⁾		120.0 ⁽¹⁰⁾		121.0 ⁽¹⁰⁾		123.0 ⁽⁹⁾	69.4	120.0 ⁽⁸⁾	86.0	118.0 ⁽⁷⁾	89.3	115.0 ⁽⁶⁾
220	B		149.0 ⁽⁹⁾		157.0 ⁽⁸⁾		156.0 ⁽⁸⁾		154.0 ⁽⁵⁾		152.0 ⁽⁴⁾	69.5	149.0 ⁽³⁾	83.3	140.0 ⁽³⁾	89.9	127.0 ⁽³⁾
	BV		74.9 ⁽⁷⁾		85.7 ⁽⁹⁾		97.3 ⁽⁹⁾		104.0 ⁽¹⁰⁾		107.0 ⁽⁹⁾		106.0 ⁽⁹⁾	58.9	105.0 ⁽⁸⁾	71.4	100.0 ⁽⁶⁾
	BW		123.0 ⁽⁷⁾		136.0 ⁽⁹⁾		139.0 ⁽⁸⁾		138.0 ⁽⁶⁾		136.0 ⁽⁴⁾		133.0 ⁽³⁾	57.2	126.0 ⁽³⁾	71.7	120.0 ⁽³⁾
230	B				66.0 ⁽⁷⁾		73.4 ⁽⁷⁾		84.6 ⁽⁹⁾		92.5 ⁽¹⁰⁾		92.1 ⁽⁹⁾		92.0 ⁽⁹⁾	44.5	87.3 ⁽⁵⁾
	BV				107.0 ⁽⁷⁾		121.0 ⁽⁷⁾		125.0 ⁽⁶⁾		122.0 ⁽⁵⁾		118.0 ⁽⁴⁾		114.0 ⁽⁴⁾	44.7	111.0 ⁽⁴⁾
	BW				57.8 ⁽⁷⁾		64.1 ⁽⁷⁾		64.1 ⁽⁷⁾		75.0 ⁽⁹⁾		78.8 ⁽¹⁰⁾		80.0 ⁽⁹⁾		77.8 ⁽⁹⁾
240	B						98.6 ⁽⁷⁾		109.0 ⁽⁷⁾		110.0 ⁽⁶⁾		106.0 ⁽⁵⁾		103.0 ⁽⁴⁾		101.0 ⁽⁴⁾
	BV								47.5 ⁽⁷⁾		55.8 ⁽⁷⁾		62.8 ⁽⁹⁾		68.8 ⁽¹⁰⁾		66.9 ⁽⁹⁾
	BW								88.3 ⁽⁷⁾		97.5 ⁽⁷⁾		96.4 ⁽⁶⁾		92.9 ⁽⁵⁾		90.5 ⁽⁴⁾
250	B										40.8 ⁽⁷⁾		44.9 ⁽⁷⁾		53.7 ⁽⁹⁾		56.8 ⁽¹⁰⁾
	BV										79.3 ⁽⁷⁾		85.1 ⁽⁷⁾		84.1 ⁽⁶⁾		80.6 ⁽⁵⁾
	BW												32.0 ⁽⁷⁾		36.3 ⁽⁷⁾		41.9 ⁽⁹⁾
260	B												69.8 ⁽⁷⁾		74.1 ⁽⁷⁾		73.2 ⁽⁶⁾
	BV														23.6 ⁽⁷⁾		16.3 ⁽⁴⁾
	BW														60.3 ⁽⁷⁾		63.0 ⁽⁷⁾
270	B																49.3 ⁽⁷⁾

1) 12° 2) 17° 3) 22° 4) 27° 5) 32° 6) 37° 7) 42° 8) 47° 9) 52° 10) 57° 11) 62°

SDWB/SDWBV/SDWBW

S 217

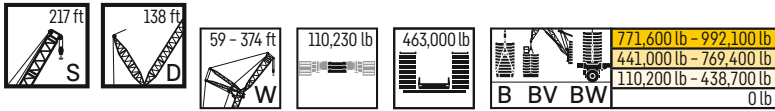

ft	S 217 ft															
	W 236 ft		W 256 ft		W 276 ft		W 295 ft		W 315 ft		W 335 ft		W 354 ft		W 374 ft	
	87°/85	WVmax	87°/85	WVmax	87°/85	WVmax	87°/85	WVmax	87°/85	WVmax	87°/85	WVmax	87°/85	WVmax	87°/85	WVmax
90	BV	392.0*	393.0 ⁽¹⁾	351.0*	351											
	BW	395.0*	396.0 ⁽¹⁾	353.0*	353											
	B	394.0	394.0	344.0*	348.0 ⁽¹⁾	309.0*	310.0 ⁽¹⁾	278.0*	278							
100	BV	399.0	399													
	BW	398.0	398.0	347.0*	347	311.0*	311	280.0*	280							
	B	388.0	388.0	346.0	346	302.0*	308.0 ⁽¹⁾	273.0*	273	243.0*	243	217.0*	217			
110	BV	393.0	395.0 ⁽¹⁾	349.0	350.0 ⁽¹⁾											
	BW	392.0	392.0	350.0	350	305.0*	305	275.0*	275	245.0*	245	217.0*	217			
	B	380.0	380.0	340.0	340.0	304.0	304	268.0*	268	239.0*	239	213.0*	213.0	190.0*	190	169.0*
120	BV	386.0	392.0 ⁽¹⁾	344.0	346.0 ⁽¹⁾	307.0	308.0 ⁽¹⁾									
	BW	385.0	385.0	345.0	345.0	308.0	308	271.0*	271	241.0*	241	214.0*	215.0 ⁽¹⁾	191.0*	191.0	170.0*
	B	371.0	375.0 ⁽²⁾	333.0	333.0	299.0	299.0	271.0	271.0	240.0	240	212.0	212.0	187.0*	187	166.0*
130	BV	379.0	388.0 ⁽¹⁾	339.0	343.0 ⁽¹⁾	303.0	305.0 ⁽¹⁾	272.0	273.0 ⁽¹⁾	241.0	242.0 ⁽¹⁾	213.0	213			
	BW	378.0	382.0 ⁽²⁾	339.0	339.0	303.0	303.0	274.0	274.0	242.0	242	214.0	214.0	188.0*	188.0	167.0*
	B	361.0	373.0 ⁽²⁾	327.0	330.0 ⁽²⁾	294.0	294.0	266.0	266.0	237.0	237.0	210.0	210	187.0	187	166.0
140	BV	370.0	385.0 ⁽¹⁾	333.0	340.0 ⁽¹⁾	298.0	302.0 ⁽¹⁾	268.0	270.0 ⁽¹⁾	238.0	239.0 ⁽¹⁾	210.0	210.0	186.0	186	163.0
	BW	369.0	381.0 ⁽²⁾	334.0	338.0 ⁽²⁾	299.0	299.0	270.0	270.0	239.0	239.0	212.0	212	189.0	189	167.0
	B	345.0	372.0 ⁽²⁾	318.0	329.0 ⁽²⁾	289.0	292.0 ⁽²⁾	261.0	262.0 ⁽²⁾	233.0	233.0	206.0	206.0	184.0	184.0	164.0
150	BV	360.0	381.0 ⁽²⁾	326.0	336.0 ⁽²⁾	293.0	299.0 ⁽¹⁾	265.0	267.0 ⁽¹⁾	235.0	236.0 ⁽¹⁾	207.0	208.0 ⁽¹⁾	183.0	183	161.0
	BW	357.0	380.0 ⁽²⁾	327.0	337.0 ⁽²⁾	294.0	298.0 ⁽²⁾	266.0	267.0 ⁽²⁾	236.0	236.0	208.0	208.0	186.0	186.0	165.0
	B	333.0	370.0 ⁽²⁾	307.0	327.0 ⁽²⁾	281.0	290.0 ⁽²⁾	256.0	260.0 ⁽²⁾	230.0	231.0 ⁽²⁾	203.0	203.0	181.0	181.0	162.0
160	BV	347.0	380.0 ⁽²⁾	317.0	335.0 ⁽²⁾	288.0	296.0 ⁽²⁾	260.0	265.0 ⁽¹⁾	232.0	234.0 ⁽¹⁾	204.0	205.0 ⁽¹⁾	180.0	180	159.0
	BW	345.0	379.0 ⁽²⁾	318.0	336.0 ⁽²⁾	289.0	297.0 ⁽²⁾	262.0	266.0 ⁽²⁾	233.0	234.0 ⁽²⁾	204.0	205.0 ⁽²⁾	183.0	183.0	163.0
	B	320.0	357.0 ⁽²⁾	294.0	325.0 ⁽²⁾	273.0	289.0 ⁽²⁾	250.0	258.0 ⁽²⁾	225.0	229.0 ⁽²⁾	199.0	200.0 ⁽²⁾	178.0	178.0	159.0
170	BV	335.0	377.0 ⁽²⁾	307.0	334.0 ⁽²⁾	281.0	295.0 ⁽²⁾	256.0	263.0 ⁽²⁾	228.0	232.0 ⁽²⁾	202.0	203.0 ⁽²⁾	176.0	177.0 ⁽²⁾	156.0
	BW	333.0	375.0 ⁽²⁾	308.0	334.0 ⁽²⁾	282.0	296.0 ⁽²⁾	257.0	265.0 ⁽²⁾	229.0	233.0 ⁽²⁾	202.0	203.0 ⁽²⁾	180.0	180.0	161.0
	B	306.0	352.0 ⁽³⁾	284.0	318.0 ⁽³⁾	264.0	286.0 ⁽³⁾	244.0	256.0 ⁽²⁾	220.0	227.0 ⁽²⁾	195.0	198.0 ⁽²⁾	175.0	176.0 ⁽²⁾	156.0
180	BV	322.0	374.0 ⁽³⁾	297.0	330.0 ⁽²⁾	272.0	294.0 ⁽²⁾	250.0	262.0 ⁽²⁾	222.0	230.0 ⁽²⁾	197.0	201.0 ⁽²⁾	173.0	175.0 ⁽²⁾	154.0
	BW	321.0	372.0 ⁽²⁾	297.0	331.0 ⁽²⁾	274.0	294.0 ⁽²⁾	250.0	264.0 ⁽²⁾	224.0	232.0 ⁽²⁾	198.0	202.0 ⁽²⁾	176.0	179.0 ⁽²⁾	157.0
	B	294.0	334.0 ⁽³⁾	274.0	317.0 ⁽³⁾	252.0	280.0 ⁽³⁾	237.0	254.0 ⁽²⁾	214.0	226.0 ⁽²⁾	189.0	197.0 ⁽²⁾	171.0	175.0 ⁽²⁾	152.0
190	BV	310.0	370.0 ⁽³⁾	286.0	328.0 ⁽³⁾	263.0	291.0 ⁽²⁾	242.0	260.0 ⁽²⁾	216.0	229.0 ⁽²⁾	191.0	200.0 ⁽²⁾	170.0	174.0 ⁽²⁾	150.0
	BW	308.0	369.0 ⁽²⁾	287.0	329.0 ⁽³⁾	264.0	291.0 ⁽²⁾	243.0	262.0 ⁽²⁾	218.0	230.0 ⁽²⁾	192.0	200.0 ⁽²⁾	173.0	177.0 ⁽²⁾	153.0
	B	283.0	323.0 ⁽⁴⁾	263.0	302.0 ⁽³⁾	244.0	280.0 ⁽³⁾	229.0	250.0 ⁽²⁾	206.0	223.0 ⁽²⁾	184.0	195.0 ⁽²⁾	168.0	173.0 ⁽²⁾	148.0
200	BV	298.0	367.0 ⁽³⁾	276.0	325.0 ⁽³⁾	254.0	288.0 ⁽³⁾	235.0	257.0 ⁽²⁾	210.0	227.0 ⁽²⁾	186.0	198.0 ⁽²⁾	167.0	172.0 ⁽²⁾	147.0
	BW	296.0	363.0 ⁽³⁾	277.0	325.0 ⁽³⁾	254.0	288.0 ⁽³⁾	236.0	259.0 ⁽²⁾	210.0	228.0 ⁽²⁾	187.0	199.0 ⁽²⁾	170.0	176.0 ⁽²⁾	149.0
	B	261.0	295.0 ⁽⁵⁾	242.0	278.0 ⁽⁴⁾	227.0	267.0 ⁽⁴⁾	213.0	242.0 ⁽³⁾	193.0	218.0 ⁽²⁾	172.0	190.0 ⁽²⁾	160.0	170.0 ⁽²⁾	139.0
220	BV	266.0	355.0 ⁽³⁾	256.0	318.0 ⁽³⁾	236.0	282.0 ⁽³⁾	219.0	253.0 ⁽³⁾	196.0	222.0 ⁽²⁾	174.0	193.0 ⁽²⁾	158.0	169.0 ⁽²⁾	138.0
	BW	261.0	349.0 ⁽³⁾	256.0	319.0 ⁽³⁾	237.0	283.0 ⁽³⁾	221.0	253.0 ⁽³⁾	196.0	223.0 ⁽²⁾	175.0	194.0 ⁽²⁾	163.0	173.0 ⁽²⁾	141.0
	B	221.0	264.0 ⁽⁶⁾	225.0	256.0 ⁽⁵⁾	209.0	247.0 ⁽⁵⁾	199.0	230.0 ⁽⁴⁾	180.0	211.0 ⁽²⁾	161.0	185.0 ⁽²⁾	149.0	166.0 ⁽²⁾	131.0
240	BV	222.0	331.0 ⁽³⁾	227.0	303.0 ⁽³⁾	220.0	275.0 ⁽³⁾	204.0	248.0 ⁽³⁾	183.0	217.0 ⁽³⁾	163.0	188.0 ⁽²⁾	148.0	165.0 ⁽²⁾	129.0
	BW	219.0	326.0 ⁽³⁾	227.0	304.0 ⁽³⁾	221.0	275.0 ⁽³⁾	205.0	248.0 ⁽³⁾	184.0	218.0 ⁽³⁾	165.0	189.0 ⁽²⁾	152.0	169.0 ⁽²⁾	133.0
	B	188.0	240.0 ⁽⁷⁾	188.0	253.0 ⁽⁴⁾	192.0	227.0 ⁽⁵⁾	183.0	215.0 ⁽⁵⁾	169.0	197.0 ⁽³⁾	149.0	179.0 ⁽⁵⁾	140.0	162.0 ⁽³⁾	123.0
260	BV	167.0	308.0 ⁽²⁾	189.0	289.0 ⁽²⁾	195.0	261.0 ⁽²⁾	191.0	240.0 ⁽³⁾	171.0	212.0 ⁽³⁾	152.0	183.0 ⁽³⁾	139.0	161.0 ⁽³⁾	121.0
	BW	166.0	305.0 ⁽²⁾	189.0	289.0 ⁽²⁾	194.0	261.0 ⁽³⁾	192.0	239.0 ⁽³⁾	173.0	214.0 ⁽³⁾	154.0	184.0 ⁽³⁾	142.0	165.0 ⁽³⁾	125.0
	B	142.0	218.0 ⁽⁸⁾	141.0	210.0 ⁽⁶⁾	162.0	206.0 ⁽⁵⁾	168.0	196.0 ⁽⁴⁾	157.0	184.0 ⁽⁴⁾	140.0	171.0 ⁽⁵⁾	131.0	159.0 ⁽³⁾	116.0
280	BV	142.0	283.0 ⁽³⁾	141.0	276.0 ⁽²⁾	162.0	252.0 ⁽²⁾	170.0	229.0 ⁽³⁾	160.0	205.0 ⁽³⁾	142.0	178.0 ⁽⁵⁾	130.0	158.0 ⁽³⁾	113.0
	BW	142.0	280.0 ⁽³⁾	141.0	275.0 ⁽²⁾	162.0	251.0 ⁽²⁾	170.0	229.0 ⁽³⁾	162.0	206.0 ⁽³⁾	143.0	179.0 ⁽⁵⁾	134.0	162.0 ⁽³⁾	118.0
	B	133.0	193.0 ⁽⁹⁾	133.0	188.0 ⁽⁸⁾	121.0	184.0 ⁽⁷⁾	141.0	179.0 ⁽⁶⁾	143.0	172.0 ⁽⁵⁾	132.0	162.0 ⁽⁴⁾	123.0	150.0 ⁽⁴⁾	108.0
300	BV	133.0	252.0 ⁽⁴⁾	140.0	248.0 ⁽³⁾	120.0	236.0 ⁽²⁾	140.0	218.0 ⁽²⁾	144.0	197.0 ⁽³⁾	133.0	172.0 ⁽³⁾	122.0	153.0 ⁽³⁾	105.0
	BW	133.0	249.0 ⁽³⁾	140.0	246.0 ⁽³⁾	122.0	235.0 ⁽²⁾	142.0	219.0 ⁽²⁾	145.0	197.0 ⁽³⁾	135.0	173.0 ⁽³⁾	126.0	157.0 ⁽³⁾	111.0
	B	112.0	167.0 ⁽¹⁰⁾	112.0	168.0 ⁽⁹⁾	112.0	168.0 ⁽⁸⁾	104.0	164.0 ⁽⁷⁾	122.0	161.0 ⁽⁶⁾	122.0	151.0 ⁽⁵⁾	116.0	142.0 ⁽⁵⁾	98.8
320	BV	112.0	225.0 ⁽⁴⁾	112.0	222.0 ⁽³⁾	112.0	216.0 ⁽³⁾	102.0	208.0 ⁽³⁾	120.0	189.0 ⁽³⁾	122.0	166.0 ⁽³⁾	114.0	148.0 ⁽³⁾	98.3
	BW	112.0	222.0 ⁽⁴⁾	112.0	221.0 ⁽³⁾	112.0	215.0 ⁽³⁾	104.0	207.0 ⁽³⁾	121.0	189.0 ⁽³⁾	124.0	167.0 ⁽³⁾	119.0	152.0 ⁽³⁾	101.0
	B	112.0	142.0 ⁽⁹⁾	112.0	146.0 ⁽¹⁰⁾	112.0	149.0 ⁽⁹⁾	112.0	148.0 ⁽⁸⁾	87.0	143.0 ⁽⁶⁾	101.0	137.0 ⁽⁶⁾	109.0	133.0 ⁽⁵⁾	92.9
340	BV	112.0	200.0 ⁽⁷⁾	112.0	198.0 ⁽⁴⁾	112.0	195.0 ⁽³⁾	112.0	191.0 ⁽³⁾	85.9	180.0 ⁽³⁾	101.0	160.0 ⁽³⁾	104.0	143.0 ⁽³⁾	92.1
	BW	112.0	199.0 ⁽⁵⁾	112.0	197.0 ⁽⁴⁾	112.0	195.0 ⁽³⁾	112.0	190.0 ⁽³⁾	86.9	180.0 ⁽³⁾	102.0	161.0 ⁽³⁾	110.0	147.0 ⁽³⁾	95.2
	B	112.0	120.0 ⁽⁹⁾	112.0	124.0 ⁽⁹⁾	112.0	129.0 ⁽⁹⁾	112.0	131.0 ⁽⁹⁾		128.0 ⁽⁹⁾	73.3	123.0 ⁽⁷⁾	88.4	122.0 ⁽⁶⁾	87.1

SDWB/SDWBV/SDWBW

S 236

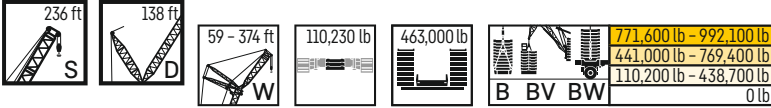

ft		S 236 ft																	
		W 59 ft		W 79 ft		W 98 ft		W 118 ft		W 138 ft		W 158 ft		W 177 ft		W 197 ft		W 217 ft	
		87°/85	WVmax	87°/85	WVmax	87°/85	WVmax	87°/85	WVmax	87°/85	WVmax	87°/85	WVmax	87°/85	WVmax	87°/85	WVmax	87°/85	WVmax
50	BV	968.0*	1015.0 ⁽¹⁾	885.0*	893.0 ⁽¹⁾														
	BW	983.0*	1033.0 ⁽¹⁾	894.0*	904.0 ⁽¹⁾														
60	BV	973.0	997.0 ⁽¹⁾	891.0	891.0	774.0*	804.0 ⁽¹⁾	707.0*	713.0 ⁽¹⁾										
	BW	992.0	1034.0 ⁽¹⁾	905.0	909.0 ⁽¹⁾														
70	BV	902.0	983.0 ⁽¹⁾	834.0	852.0 ⁽²⁾	788.0	794.0 ⁽¹⁾	724.0	724.0	619.0*	639.0 ⁽¹⁾	566.0*	569.0 ⁽¹⁾						
	BW	925.0	1037.0 ⁽¹⁾	852.0	876.0 ⁽²⁾	806.0	823.0 ⁽¹⁾	737.0	737.0										
80	BV	820.0	959.0 ⁽¹⁾	778.0	841.0 ⁽²⁾	745.0	786.0 ⁽¹⁾	690.0	705.0 ⁽¹⁾	625.0*	648.0 ⁽¹⁾	570.0*	574.0 ⁽¹⁾						
	BW	823.0	1029.0 ⁽¹⁾	793.0	906.0 ⁽¹⁾	766.0	823.0 ⁽¹⁾	705.0	732.0 ⁽¹⁾	646.0	653.0 ⁽¹⁾	586.0	586.0	494.0*	507.0 ⁽¹⁾	452.0*	454.0 ⁽¹⁾		
90	BV	865.0 ⁽²⁾	722.0	829.0 ⁽²⁾	699.0	779.0 ⁽¹⁾	650.0	700.0 ⁽¹⁾	602.0	627.0 ⁽¹⁾	557.0	562.0 ⁽¹⁾	501.0*	513.0 ⁽¹⁾	456.0*	457.0 ⁽¹⁾	395.0*	401.0 ⁽¹⁾	
	BW	983.0 ⁽¹⁾	737.0	891.0 ⁽¹⁾	725.0	825.0 ⁽¹⁾	670.0	731.0 ⁽¹⁾	618.0	651.0 ⁽¹⁾	569.0	581.0 ⁽¹⁾	514.0	515.0 ⁽¹⁾	462.0	462.0	400.0*	406.0 ⁽¹⁾	
100	BV	782.0 ⁽⁵⁾	624.0	770.0 ⁽³⁾	657.0	737.0 ⁽²⁾	614.0	696.0 ⁽¹⁾	568.0	625.0 ⁽¹⁾	529.0	558.0 ⁽¹⁾	487.0	495.0 ⁽¹⁾	446.0	446.0	400.0	400.0	
	BW	938.0 ⁽¹⁾	625.0	855.0 ⁽²⁾	680.0	815.0 ⁽¹⁾	633.0	729.0 ⁽¹⁾	587.0	648.0 ⁽¹⁾	544.0	579.0 ⁽¹⁾	498.0	513.0 ⁽¹⁾	453.0	457.0 ⁽¹⁾	405.0	406.0 ⁽¹⁾	
110	BV	710.0 ⁽⁷⁾	623.0	702.0 ⁽⁴⁾	616.0	688.0 ⁽³⁾	577.0	656.0 ⁽²⁾	539.0	617.0 ⁽¹⁾	503.0	556.0 ⁽¹⁾	465.0	487.0 ⁽¹⁾	432.0	432.0	392.0	392.0	
	BW	885.0 ⁽³⁾	623.0	833.0 ⁽²⁾	638.0	797.0 ⁽¹⁾	596.0	720.0 ⁽¹⁾	557.0	645.0 ⁽¹⁾	519.0	576.0 ⁽¹⁾	478.0	510.0 ⁽¹⁾	441.0	455.0 ⁽¹⁾	398.0	403.0 ⁽¹⁾	
120	BV	641.0 ⁽⁸⁾	643.0 ⁽⁶⁾	572.0	636.0 ⁽⁴⁾	545.0	615.0 ⁽³⁾	509.0	582.0 ⁽²⁾	478.0	544.0 ⁽¹⁾	444.0	479.0 ⁽¹⁾	414.0	425.0 ⁽²⁾	379.0	379.0		
	BW	833.0 ⁽⁵⁾	643.0 ⁽⁶⁾	806.0 ⁽²⁾	577.0	780.0 ⁽¹⁾	562.0	709.0 ⁽¹⁾	526.0	637.0 ⁽¹⁾	494.0	572.0 ⁽¹⁾	458.0	508.0 ⁽¹⁾	425.0	452.0 ⁽¹⁾	388.0	401.0 ⁽¹⁾	
130	BV	578.0 ⁽¹¹⁾	586.0 ⁽⁷⁾	587.0 ⁽⁶⁾	512.0	571.0 ⁽⁴⁾	483.0	549.0 ⁽³⁾	454.0	523.0 ⁽²⁾	421.0	473.0 ⁽²⁾	397.0	424.0 ⁽²⁾	365.0	377.0 ⁽²⁾			
	BW	773.0 ⁽⁵⁾	586.0 ⁽⁷⁾	742.0 ⁽²⁾	533.0	698.0 ⁽¹⁾	497.0	629.0 ⁽¹⁾	468.0	566.0 ⁽¹⁾	437.0	492.0 ⁽²⁾	408.0	450.0 ⁽¹⁾	375.0	398.0 ⁽¹⁾			
140	BV	601.0 ⁽¹¹⁾	765.0 ⁽²⁾	748.0 ⁽²⁾	535.0	699.0 ⁽¹⁾	499.0	613.0 ⁽²⁾	471.0	552.0 ⁽²⁾	439.0	493.0 ⁽²⁾	410.0	442.0 ⁽²⁾	377.0	392.0 ⁽²⁾			
	BW	713.0 ⁽⁵⁾	765.0 ⁽²⁾	748.0 ⁽²⁾	535.0	699.0 ⁽¹⁾	499.0	613.0 ⁽²⁾	471.0	552.0 ⁽²⁾	439.0	493.0 ⁽²⁾	410.0	442.0 ⁽²⁾	377.0	392.0 ⁽²⁾			
150	BV		534.0 ⁽⁸⁾	544.0 ⁽⁸⁾	473.0	534.0 ⁽⁵⁾	458.0	518.0 ⁽⁴⁾	430.0	494.0 ⁽³⁾	402.0	466.0 ⁽²⁾	377.0	425.0 ⁽²⁾	351.0	377.0 ⁽²⁾			
	BW		706.0 ⁽⁴⁾	698.0 ⁽³⁾	484.0	668.0 ⁽²⁾	471.0	620.0 ⁽¹⁾	444.0	559.0 ⁽¹⁾	416.0	490.0 ⁽²⁾	391.0	441.0 ⁽²⁾	361.0	390.0 ⁽²⁾			
160	BV		494.0 ⁽¹¹⁾	504.0 ⁽¹⁰⁾	433.0	501.0 ⁽⁷⁾	433.0	488.0 ⁽⁵⁾	410.0	468.0 ⁽¹⁾	384.0	446.0 ⁽³⁾	360.0	418.0 ⁽²⁾	337.0	378.0 ⁽²⁾			
	BW	653.0 ⁽⁵⁾	664.0 ⁽¹¹⁾	652.0 ⁽³⁾	450.0	634.0 ⁽³⁾	450.0	602.0 ⁽²⁾	423.0	551.0 ⁽¹⁾	395.0	486.0 ⁽²⁾	373.0	439.0 ⁽²⁾	347.0	390.0 ⁽²⁾			
170	BV		456.0 ⁽¹³⁾	462.0 ⁽¹⁰⁾	408.0	467.0 ⁽⁹⁾	408.0	456.0 ⁽⁴⁾	390.0	443.0 ⁽¹⁾	365.0	422.0 ⁽³⁾	345.0	401.0 ⁽³⁾	320.0	371.0 ⁽²⁾			
	BW	595.0 ⁽⁶⁾	626.0 ⁽¹¹⁾	608.0 ⁽⁴⁾	416.0	601.0 ⁽⁴⁾	416.0	580.0 ⁽³⁾	404.0	537.0 ⁽²⁾	376.0	481.0 ⁽²⁾	356.0	435.0 ⁽²⁾	332.0	388.0 ⁽²⁾			
180	BV		419.0 ⁽¹⁰⁾	423.0 ⁽¹⁰⁾	392.0 ⁽¹⁰⁾	399.0 ⁽¹⁰⁾	399.0 ⁽¹⁰⁾	434.0 ⁽¹⁰⁾	372.0	421.0 ⁽⁶⁾	348.0	402.0 ⁽⁴⁾	331.0	383.0 ⁽³⁾	307.0	361.0 ⁽³⁾			
	BW	512.0 ⁽⁷⁾	551.0 ⁽¹¹⁾	531.0 ⁽⁸⁾	350.0	531.0 ⁽⁸⁾	350.0	525.0 ⁽³⁾	342.0	500.0 ⁽⁴⁾	345.0	461.0 ⁽³⁾	326.0	428.0 ⁽²⁾	304.0	382.0 ⁽²⁾			
190	BV		383.0 ⁽¹⁰⁾	392.0 ⁽¹⁰⁾	333.0	399.0 ⁽¹⁰⁾	333.0	407.0 ⁽¹⁰⁾	340.0	400.0 ⁽⁷⁾	333.0	382.0 ⁽⁵⁾	314.0	366.0 ⁽⁴⁾	294.0	347.0 ⁽³⁾			
	BW	475.0 ⁽⁷⁾	513.0 ⁽¹¹⁾	493.0 ⁽⁸⁾	300.0	499.0 ⁽⁸⁾	300.0	495.0 ⁽⁴⁾	327.0	447.0 ⁽³⁾	327.0	447.0 ⁽³⁾	313.0	414.0 ⁽²⁾	291.0	379.0 ⁽²⁾			
200	BV		319.0 ⁽⁸⁾	329.0 ⁽¹⁰⁾	285.0	342.0 ⁽¹⁰⁾	285.0	349.0 ⁽¹¹⁾	285.0	355.0 ⁽¹⁰⁾	285.0	344.0 ⁽⁷⁾	289.0	335.0 ⁽⁶⁾	270.0	320.0 ⁽⁵⁾			
	BW	439.0 ⁽⁷⁾	475.0 ⁽¹¹⁾	454.0 ⁽⁸⁾	250.0	466.0 ⁽⁸⁾	250.0	466.0 ⁽⁴⁾	286.0	457.0 ⁽⁵⁾	286.0	432.0 ⁽⁴⁾	299.0	405.0 ⁽³⁾	281.0	369.0 ⁽²⁾			
220	BV		266.0 ⁽⁸⁾	276.0 ⁽⁸⁾	229.0	289.0 ⁽¹⁰⁾	229.0	300.0 ⁽¹⁰⁾	229.0	308.0 ⁽¹⁰⁾	229.0	311.0 ⁽⁹⁾	237.0	306.0 ⁽⁸⁾	249.0	290.0 ⁽⁶⁾			
	BW	376.0 ⁽⁵⁾	399.0 ⁽¹¹⁾	393.0 ⁽⁸⁾	190.0	403.0 ⁽⁹⁾	190.0	407.0 ⁽⁷⁾	212.0 ⁽⁸⁾	407.0 ⁽⁷⁾	212.0 ⁽⁸⁾	391.0 ⁽⁴⁾	237.0	377.0 ⁽⁴⁾	257.0	352.0 ⁽⁴⁾			
240	BV				232.0 ⁽⁸⁾	238.0 ⁽⁸⁾	194.0 ⁽⁸⁾	212.0 ⁽⁸⁾	194.0 ⁽⁸⁾	212.0 ⁽⁸⁾	194.0 ⁽⁸⁾	227.0 ⁽¹⁰⁾	237.0 ⁽¹¹⁾	242.0 ⁽¹⁰⁾	201.0	266.0 ⁽⁸⁾			
	BW		330.0 ⁽⁶⁾		340.0 ⁽⁸⁾	351.0 ⁽⁸⁾	304.0 ⁽⁸⁾	357.0 ⁽⁹⁾	304.0 ⁽⁸⁾	357.0 ⁽⁹⁾	304.0 ⁽⁸⁾	357.0 ⁽⁹⁾	352.0 ⁽⁵⁾	345.0 ⁽⁴⁾	201.0	328.0 ⁽⁴⁾			
260	BV																		
	BW																		
280	BV																		
	BW																		
300	BV																		
	BW																		
320	BV																		
	BW																		
340	BV																		
	BW																		
360	BV																		
	BW																		
380	BV																		
	BW																		

1) 12° 2) 17° 3) 22° 4) 27° 5) 32° 6) 37° 7) 42° 8) 47° 9) 52° 10) 57° 11) 62°

SDWB/SDWBV/SDWBW

S 236

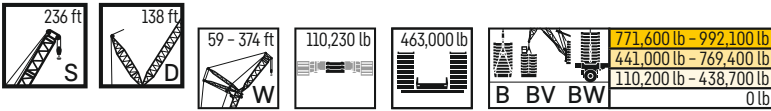

ft	B BV BW	S 236 ft															
		W 236 ft		W 256 ft		W 276 ft		W 295 ft		W 315 ft		W 335 ft		W 354 ft		W 374 ft	
		87°/85	WVmax	87°/85	WVmax	87°/85	WVmax	87°/85	WVmax	87°/85	WVmax	87°/85	WVmax	87°/85	WVmax	87°/85	WVmax
90	B	359.0*	360.0 ⁽¹⁾	321.0*	321.0*												
90	BV	362.0*	363.0 ⁽¹⁾	324.0*	324.0*												
90	BW	349.0*	359.0 ⁽¹⁾	315.0*	318.0 ⁽¹⁾	284.0*	284.0*	254.0*	254.0*								
100	B	353.0*	363.0 ⁽¹⁾	317.0*	317.0*	286.0*	287.0 ⁽¹⁾	255.0*	255.0*								
100	BV	354.0	354.0	317.0	317.0	279.0*	281.0 ⁽¹⁾	250.0*	250.0*	224.0*	224.0*	199.0*	199.0*				
100	BW	359.0	360.0 ⁽¹⁾	309.0*	309.0*	281.0*	286.0 ⁽¹⁾	251.0*	251.0*	225.0*	225.0*	198.0*	198.0*				
110	B	347.0	347.0	311.0	311.0	281.0	281.0	245.0*	245.0*	220.0*	223.0 ⁽¹⁾	196.0*	197.0 ⁽¹⁾	176.0*	176.0*	154.0*	154.0*
110	BV	352.0	358.0 ⁽¹⁾	315.0	317.0 ⁽¹⁾	283.0	284.0 ⁽¹⁾	252.0	252.0	221.0*	224.0 ⁽¹⁾	195.0*	196.0 ⁽¹⁾	177.0*	177.0*	156.0*	156.0*
110	BW	353.0	353.0	316.0	316.0	285.0	285.0	252.0	252.0	221.0*	224.0 ⁽¹⁾	195.0*	196.0 ⁽¹⁾	177.0*	177.0*	156.0*	156.0*
120	B	337.0	339.0 ⁽²⁾	305.0	305.0	277.0	277.0	247.0	247.0	221.0	221.0	196.0	196.0	173.0*	173.0*	151.0*	152.0 ⁽¹⁾
120	BV	344.0	355.0 ⁽¹⁾	309.0	314.0 ⁽¹⁾	279.0	281.0 ⁽¹⁾	250.0	250.0	222.0	222.0	195.0	195.0	174.0*	174.0*	152.0*	153.0 ⁽¹⁾
120	BW	345.0	350.0 ⁽²⁾	311.0	311.0	281.0	281.0	250.0	250.0	223.0	223.0	196.0	196.0	174.0*	174.0*	152.0*	153.0 ⁽¹⁾
130	B	327.0	337.0 ⁽²⁾	296.0	300.0 ⁽²⁾	272.0	272.0	244.0	244.0	218.0	218.0	194.0	194.0	170.0*	170.0*	148.0*	151.0 ⁽¹⁾
130	BV	334.0	353.0 ⁽¹⁾	302.0	312.0 ⁽¹⁾	275.0	279.0 ⁽¹⁾	246.0	248.0 ⁽¹⁾	219.0	220.0 ⁽¹⁾	193.0	193.0	171.0	171.0	149.0	149.0
130	BW	336.0	349.0 ⁽²⁾	303.0	309.0 ⁽²⁾	276.0	276.0	247.0	247.0	221.0	221.0	193.0	193.0	171.0*	171.0*	149.0*	152.0 ⁽¹⁾
140	B	314.0	337.0 ⁽²⁾	288.0	299.0 ⁽²⁾	266.0	270.0 ⁽²⁾	239.0	240.0 ⁽²⁾	215.0	215.0	191.0	191.0	171.0	171.0	149.0	149.0
140	BV	323.0	348.0 ⁽²⁾	294.0	309.0 ⁽¹⁾	270.0	277.0 ⁽¹⁾	242.0	246.0 ⁽¹⁾	216.0	217.0 ⁽¹⁾	190.0	191.0 ⁽¹⁾	169.0	169.0	147.0	147.0
140	BW	324.0	348.0 ⁽²⁾	295.0	308.0 ⁽²⁾	271.0	276.0 ⁽²⁾	243.0	244.0 ⁽²⁾	218.0	218.0	191.0	191.0	173.0	173.0	150.0	150.0
150	B	302.0	337.0 ⁽²⁾	278.0	298.0 ⁽²⁾	257.0	268.0 ⁽²⁾	234.0	239.0 ⁽²⁾	211.0	212.0 ⁽²⁾	188.0	188.0	169.0	169.0	147.0	147.0
150	BV	311.0	347.0 ⁽²⁾	285.0	306.0 ⁽²⁾	263.0	274.0 ⁽¹⁾	238.0	244.0 ⁽¹⁾	213.0	215.0 ⁽¹⁾	188.0	189.0 ⁽¹⁾	166.0	166.0	145.0	146.0 ⁽¹⁾
150	BW	313.0	348.0 ⁽²⁾	286.0	307.0 ⁽²⁾	264.0	275.0 ⁽²⁾	239.0	243.0 ⁽²⁾	215.0	216.0 ⁽²⁾	189.0	189.0	170.0	170.0	148.0	148.0
160	B	290.0	329.0 ⁽²⁾	268.0	297.0 ⁽²⁾	249.0	267.0 ⁽²⁾	228.0	237.0 ⁽²⁾	206.0	211.0 ⁽²⁾	185.0	186.0 ⁽²⁾	166.0	166.0	145.0	145.0
160	BV	299.0	345.0 ⁽²⁾	275.0	306.0 ⁽²⁾	255.0	273.0 ⁽²⁾	232.0	241.0 ⁽²⁾	209.0	213.0 ⁽¹⁾	185.0	187.0 ⁽²⁾	164.0	164.0	143.0	144.0 ⁽¹⁾
160	BW	300.0	346.0 ⁽²⁾	277.0	306.0 ⁽²⁾	256.0	274.0 ⁽²⁾	234.0	242.0 ⁽²⁾	211.0	215.0 ⁽²⁾	186.0	187.0 ⁽²⁾	168.0	168.0	146.0	146.0
170	B	276.0	324.0 ⁽³⁾	259.0	291.0 ⁽²⁾	241.0	266.0 ⁽²⁾	222.0	236.0 ⁽²⁾	200.0	209.0 ⁽²⁾	182.0	185.0 ⁽²⁾	163.0	165.0 ⁽²⁾	143.0	143.0
170	BV	287.0	342.0 ⁽²⁾	266.0	303.0 ⁽²⁾	247.0	272.0 ⁽²⁾	226.0	241.0 ⁽²⁾	204.0	212.0 ⁽²⁾	182.0	185.0 ⁽²⁾	161.0	163.0 ⁽²⁾	141.0	142.0 ⁽¹⁾
170	BW	288.0	343.0 ⁽²⁾	267.0	304.0 ⁽²⁾	248.0	273.0 ⁽²⁾	228.0	242.0 ⁽²⁾	206.0	214.0 ⁽²⁾	183.0	186.0 ⁽²⁾	165.0	167.0 ⁽²⁾	144.0	145.0 ⁽²⁾
180	B	266.0	312.0 ⁽³⁾	247.0	287.0 ⁽³⁾	233.0	260.0 ⁽²⁾	214.0	235.0 ⁽²⁾	194.0	208.0 ⁽²⁾	178.0	184.0 ⁽²⁾	160.0	164.0 ⁽²⁾	140.0	142.0 ⁽²⁾
180	BV	275.0	340.0 ⁽²⁾	256.0	301.0 ⁽²⁾	239.0	269.0 ⁽²⁾	219.0	240.0 ⁽²⁾	199.0	211.0 ⁽²⁾	177.0	184.0 ⁽²⁾	158.0	162.0 ⁽²⁾	138.0	140.0 ⁽²⁾
180	BW	277.0	340.0 ⁽²⁾	256.0	301.0 ⁽²⁾	241.0	271.0 ⁽²⁾	221.0	241.0 ⁽²⁾	200.0	213.0 ⁽²⁾	178.0	185.0 ⁽²⁾	162.0	166.0 ⁽²⁾	142.0	144.0 ⁽²⁾
190	B	255.0	304.0 ⁽⁴⁾	236.0	279.0 ⁽³⁾	225.0	258.0 ⁽³⁾	207.0	231.0 ⁽²⁾	189.0	206.0 ⁽²⁾	173.0	182.0 ⁽²⁾	156.0	162.0 ⁽²⁾	137.0	140.0 ⁽²⁾
190	BV	264.0	337.0 ⁽²⁾	246.0	298.0 ⁽²⁾	231.0	267.0 ⁽²⁾	213.0	237.0 ⁽²⁾	193.0	210.0 ⁽²⁾	171.0	183.0 ⁽²⁾	154.0	161.0 ⁽²⁾	135.0	139.0 ⁽²⁾
190	BW	266.0	337.0 ⁽²⁾	247.0	298.0 ⁽²⁾	232.0	269.0 ⁽²⁾	214.0	238.0 ⁽²⁾	194.0	212.0 ⁽²⁾	173.0	184.0 ⁽²⁾	159.0	165.0 ⁽²⁾	139.0	142.0 ⁽²⁾
200	B	236.0	277.0 ⁽⁵⁾	219.0	263.0 ⁽⁴⁾	207.0	244.0 ⁽³⁾	193.0	225.0 ⁽²⁾	177.0	200.0 ⁽²⁾	162.0	178.0 ⁽²⁾	147.0	159.0 ⁽²⁾	129.0	138.0 ⁽²⁾
200	BV	245.0	328.0 ⁽³⁾	227.0	293.0 ⁽³⁾	214.0	263.0 ⁽³⁾	199.0	234.0 ⁽³⁾	181.0	205.0 ⁽²⁾	160.0	179.0 ⁽²⁾	146.0	158.0 ⁽²⁾	127.0	137.0 ⁽²⁾
200	BW	246.0	327.0 ⁽³⁾	228.0	293.0 ⁽³⁾	216.0	264.0 ⁽³⁾	200.0	234.0 ⁽³⁾	182.0	207.0 ⁽²⁾	162.0	181.0 ⁽²⁾	150.0	163.0 ⁽²⁾	131.0	140.0 ⁽²⁾
220	B	217.0	256.0 ⁽⁷⁾	202.0	245.0 ⁽⁵⁾	191.0	233.0 ⁽⁵⁾	178.0	214.0 ⁽²⁾	166.0	193.0 ⁽²⁾	150.0	174.0 ⁽²⁾	138.0	155.0 ⁽²⁾	121.0	134.0 ⁽²⁾
220	BV	224.0	310.0 ⁽⁴⁾	211.0	285.0 ⁽³⁾	199.0	260.0 ⁽³⁾	185.0	230.0 ⁽³⁾	169.0	201.0 ⁽²⁾	150.0	175.0 ⁽²⁾	136.0	154.0 ⁽²⁾	119.0	133.0 ⁽²⁾
220	BW	224.0	309.0 ⁽⁴⁾	214.0	285.0 ⁽³⁾	200.0	261.0 ⁽³⁾	186.0	231.0 ⁽³⁾	171.0	201.0 ⁽²⁾	150.0	176.0 ⁽²⁾	140.0	158.0 ⁽²⁾	124.0	137.0 ⁽²⁾
240	B	174.0	234.0 ⁽⁷⁾	186.0	226.0 ⁽⁴⁾	178.0	218.0 ⁽⁴⁾	165.0	201.0 ⁽³⁾	152.0	184.0 ⁽³⁾	141.0	168.0 ⁽³⁾	129.0	150.0 ⁽²⁾	114.0	130.0 ⁽²⁾
240	BV	173.0	292.0 ⁽²⁾	192.0	272.0 ⁽²⁾	185.0	252.0 ⁽³⁾	172.0	226.0 ⁽³⁾	158.0	197.0 ⁽³⁾	140.0	170.0 ⁽²⁾	128.0	151.0 ⁽²⁾	111.0	129.0 ⁽²⁾
240	BW	174.0	292.0 ⁽²⁾	192.0	271.0 ⁽²⁾	187.0	252.0 ⁽³⁾	175.0	226.0 ⁽³⁾	160.0	197.0 ⁽³⁾	141.0	171.0 ⁽²⁾	132.0	154.0 ⁽³⁾	116.0	133.0 ⁽²⁾
260	B	210.0 ⁽⁷⁾	147.0	206.0 ⁽⁶⁾	163.0	200.0 ⁽⁷⁾	154.0	188.0 ⁽⁴⁾	141.0	174.0 ⁽⁴⁾	132.0	162.0 ⁽³⁾	122.0	146.0 ⁽³⁾	107.0	126.0 ⁽³⁾	
260	BV	272.0 ⁽²⁾	148.0	262.0 ⁽²⁾	167.0	243.0 ⁽⁷⁾	160.0	219.0 ⁽³⁾	147.0	192.0 ⁽³⁾	131.0	166.0 ⁽³⁾	119.0	147.0 ⁽³⁾	103.0	125.0 ⁽²⁾	
260	BW	272.0 ⁽³⁾	147.0	262.0 ⁽²⁾	167.0	243.0 ⁽⁷⁾	162.0	219.0 ⁽³⁾	148.0	192.0 ⁽³⁾	132.0	167.0 ⁽³⁾	124.0	150.0 ⁽³⁾	109.0	129.0 ⁽²⁾	
300	B	189.0 ⁽¹⁰⁾		186.0 ⁽⁹⁾	129.0	182.0 ⁽⁸⁾	139.0	174.0 ⁽⁷⁾	132.0	163.0 ⁽⁶⁾	124.0	153.0 ⁽⁴⁾	114.0	139.0 ⁽⁴⁾	97.7	123.0 ⁽³⁾	
300	BV	251.0 ⁽⁴⁾		244.0 ⁽³⁾	128.0	234.0 ⁽³⁾	142.0	212.0 ⁽³⁾	138.0	187.0 ⁽³⁾	123.0	161.0 ⁽³⁾	111.0	143.0 ⁽³⁾	96.2	121.0 ⁽³⁾	
300	BW	249.0 ⁽⁴⁾		244.0 ⁽³⁾	129.0	234.0 ⁽³⁾	143.0	211.0 ⁽³⁾	139.0	187.0 ⁽³⁾	125.0	162.0 ⁽³⁾	117.0	146.0 ⁽³⁾	99.9	126.0 ⁽³⁾	
320	B	165.0 ⁽¹⁰⁾		171.0 ⁽¹⁰⁾		166.0 ⁽⁹⁾	110.0	160.0 ⁽⁸⁾	121.0	153.0 ⁽⁷⁾	116.0	144.0 ⁽⁵⁾	107.0	133.0 ⁽⁴⁾	91.3	118.0 ⁽⁴⁾	
320	BV	229.0 ⁽⁵⁾		224.0 ⁽⁴⁾		222.0 ⁽³⁾	108.0	205.0 ⁽³⁾	121.0	181.0 ⁽³⁾	115.0	157.0 ⁽³⁾	104.0	139.0 ⁽³⁾	89.6	118.0 ⁽³⁾	
320	BW	228.0 ⁽⁵⁾		224.0 ⁽⁴⁾		222.0 ⁽³⁾	110.0	204.0 ⁽³⁾	123.0	181.0 ⁽³⁾	117.0	157.0 ⁽³⁾	110.0	142.0 ⁽³⁾	93.3	122.0 ⁽³⁾	
340	B	141.0 ⁽¹¹⁾		147.0 ⁽¹⁰⁾		149.0 ⁽¹⁰⁾		147.0 ⁽⁹⁾	90.8	142.0 ⁽⁷⁾	104.0	135.0 ⁽⁶⁾	97.7	127.0 ⁽⁵⁾	85.8	112.0 ⁽⁵⁾	
340	BV	206.0 ⁽⁸⁾		200.0 ⁽⁹⁾		201.0 ⁽⁴⁾		193.0 ⁽³⁾	90.6	176.0 ⁽⁵⁾	102.0	152.0 ⁽⁵⁾	97.6	135.0 ⁽⁴⁾	83.8	114.0 ⁽³⁾	
340	BW	206.0 ⁽⁷⁾		200.0 ⁽⁴⁾		199.0 ⁽⁵⁾		191.0 ⁽⁵⁾	91.1	176.0 ⁽⁵⁾	102.0	152.0 ⁽⁴⁾	101.0	138.0 ⁽⁴⁾	87.9	119.0 ⁽³⁾	
360	B	117.0 ⁽⁹⁾		124.0 ⁽¹¹⁾		130.0 ⁽¹⁰⁾		131.0 ⁽¹⁰⁾		130.0 ⁽⁹⁾	79.3	126.0 ⁽⁸⁾	88.4	119.0 ⁽⁶⁾	80.3	107.0 ⁽⁶⁾	
360	BV	184.0 ⁽⁸⁾		179.0 ⁽⁹⁾		180.0 ⁽⁴⁾		174.0 ⁽⁴⁾		165.0 ⁽⁴⁾	74.5	148.0 ⁽⁴⁾	85.2	132.0 ⁽⁴⁾	77.9	111.0 ⁽⁴⁾	
360	BW	185.0 ⁽⁸⁾		179.0 ⁽⁵⁾		178.0 ⁽⁴⁾		174.0 ⁽⁴⁾		166.0 ⁽⁴⁾	76.9	148.0 ⁽⁴⁾	89.0	135.0 ⁽⁴⁾	82.4	116.0 ⁽⁴⁾	
380	B	96.1 ⁽⁹⁾		101.0 ⁽⁹⁾													

SDWB/SDWBV/SDWBW

S 256

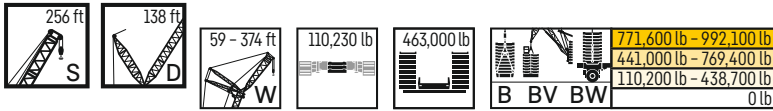

ft	ft	S 256 ft																	
		W 59 ft		W 79 ft		W 98 ft		W 118 ft		W 138 ft		W 158 ft		W 177 ft		W 197 ft		W 217 ft	
		87°/85	WVmax	87°/85	WVmax	87°/85	WVmax	87°/85	WVmax	87°/85	WVmax	87°/85	WVmax	87°/85	WVmax	87°/85	WVmax	87°/85	WVmax
50	B	866.0*	899.0 ⁽¹⁾	789.0*	789.0*														
	BV	874.0	889.0 ⁽¹⁾	792.0	792.0	693.0*	714.0 ⁽¹⁾	632.0*	634.0 ⁽¹⁾										
	BW	880.0	908.0 ⁽¹⁾																
60	B	886.0	914.0 ⁽¹⁾	745.0*	769.0 ⁽¹⁾	700.0*	722.0 ⁽¹⁾	637.0*	638.0 ⁽¹⁾										
	BV	818.0	887.0 ⁽¹⁾	753.0	763.0 ⁽²⁾	706.0	708.0 ⁽²⁾	605.0*	639.0 ⁽¹⁾	555.0*	567.0 ⁽¹⁾	506.0*	506.0*						
	BW	820.0	908.0 ⁽¹⁾	753.0	796.0 ⁽¹⁾	715.0	725.0 ⁽¹⁾	653.0	653.0										
70	B	826.0	913.0 ⁽¹⁾	758.0	771.0 ⁽²⁾	719.0	729.0 ⁽¹⁾	611.0*	647.0 ⁽¹⁾	559.0*	574.0 ⁽¹⁾	508.0*	509.0 ⁽¹⁾						
	BV	766.0	884.0 ⁽¹⁾	707.0	755.0 ⁽²⁾	669.0	704.0 ⁽²⁾	615.0	629.0 ⁽¹⁾	565.0	565.0	485.0*	507.0 ⁽¹⁾	444.0*	453.0 ⁽¹⁾	405.0*	405.0*		
	BW	765.0	908.0 ⁽¹⁾	705.0	795.0 ⁽¹⁾	680.0	724.0 ⁽¹⁾	626.0	645.0 ⁽¹⁾	574.0	577.0 ⁽¹⁾	577.0	580.0 ⁽¹⁾						
80	B	771.0	912.0 ⁽¹⁾	710.0	770.0 ⁽²⁾	684.0	728.0 ⁽¹⁾	630.0	648.0 ⁽¹⁾			492.0*	516.0 ⁽¹⁾	449.0*	459.0 ⁽¹⁾	409.0*	409.0*		
	BV	591.0	827.0 ⁽²⁾	659.0	749.0 ⁽²⁾	628.0	703.0 ⁽¹⁾	582.0	626.0 ⁽¹⁾	538.0	560.0 ⁽¹⁾	496.0	501.0 ⁽¹⁾	453.0	453.0	390.0*	406.0 ⁽¹⁾	357.0*	363.0 ⁽¹⁾
	BW	595.0	894.0 ⁽¹⁾	658.0	793.0 ⁽¹⁾	642.0	723.0 ⁽¹⁾	594.0	643.0 ⁽¹⁾	548.0	575.0 ⁽¹⁾	504.0	515.0 ⁽¹⁾	461.0	461.0				
90	B	595.0	883.0 ⁽²⁾	663.0	769.0 ⁽²⁾	647.0	727.0 ⁽¹⁾	598.0	646.0 ⁽¹⁾	551.0	577.0 ⁽¹⁾	506.0	517.0 ⁽¹⁾	463.0	463.0	395.0*	412.0 ⁽¹⁾	360.0*	367.0 ⁽¹⁾
	BV		763.0 ⁽⁴⁾	618.0	722.0 ⁽²⁾	591.0	688.0 ⁽¹⁾	550.0	624.0 ⁽¹⁾	510.0	558.0 ⁽¹⁾	472.0	498.0 ⁽¹⁾	436.0	449.0 ⁽¹⁾	400.0	400.0	366.0	366.0
	BW		876.0 ⁽¹⁾	618.0	764.0 ⁽²⁾	604.0	721.0 ⁽¹⁾	561.0	641.0 ⁽¹⁾	521.0	572.0 ⁽¹⁾	482.0	512.0 ⁽¹⁾	444.0	459.0 ⁽¹⁾	407.0	411.0 ⁽¹⁾	369.0	369.0
100	B		873.0 ⁽²⁾	623.0	767.0 ⁽²⁾	608.0	724.0 ⁽¹⁾	565.0	644.0 ⁽¹⁾	524.0	574.0 ⁽¹⁾	485.0	515.0 ⁽¹⁾	446.0	446.0	409.0	409.0	371.0	371.0
	BV		698.0 ⁽⁹⁾	470.0	670.0 ⁽³⁾	557.0	643.0 ⁽²⁾	518.0	604.0 ⁽¹⁾	485.0	557.0 ⁽¹⁾	450.0	497.0 ⁽¹⁾	417.0	446.0 ⁽¹⁾	386.0	386.0	354.0	354.0
	BW		853.0 ⁽¹⁾	474.0	763.0 ⁽²⁾	567.0	716.0 ⁽¹⁾	530.0	640.0 ⁽¹⁾	494.0	569.0 ⁽¹⁾	460.0	510.0 ⁽¹⁾	425.0	456.0 ⁽¹⁾	392.0	409.0 ⁽¹⁾	359.0	366.0 ⁽¹⁾
110	B		863.0 ⁽²⁾	473.0	768.0 ⁽²⁾	571.0	723.0 ⁽¹⁾	534.0	641.0 ⁽¹⁾	498.0	572.0 ⁽¹⁾	462.0	512.0 ⁽¹⁾	429.0	438.0 ⁽²⁾	394.0	394.0	362.0	362.0
	BV		636.0 ⁽⁶⁾		629.0 ⁽⁷⁾	529.0	602.0 ⁽⁴⁾	491.0	573.0 ⁽²⁾	458.0	533.0 ⁽²⁾	429.0	495.0 ⁽¹⁾	398.0	444.0 ⁽¹⁾	370.0	379.0 ⁽²⁾	342.0	342.0
	BW		804.0 ⁽⁴⁾		761.0 ⁽²⁾	537.0	711.0 ⁽¹⁾	499.0	640.0 ⁽¹⁾	468.0	569.0 ⁽¹⁾	438.0	507.0 ⁽¹⁾	407.0	454.0 ⁽¹⁾	377.0	407.0 ⁽¹⁾	348.0	364.0 ⁽¹⁾
120	B		810.0 ⁽⁴⁾		770.0 ⁽²⁾	542.0	723.0 ⁽¹⁾	503.0	640.0 ⁽¹⁾	472.0	555.0 ⁽¹⁾	441.0	507.0 ⁽¹⁾	410.0	438.0 ⁽²⁾	380.0	392.0 ⁽²⁾	350.0	351.0 ⁽²⁾
	BV																		
	BW																		
130	B																		
	BV																		
	BW																		
140	B																		
	BV																		
	BW																		
150	B																		
	BV																		
	BW																		
160	B																		
	BV																		
	BW																		
170	B																		
	BV																		
	BW																		
180	B																		
	BV																		
	BW																		
190	B																		
	BV																		
	BW																		
200	B																		
	BV																		
	BW																		
220	B																		
	BV																		
	BW																		
240	B																		
	BV																		
	BW																		
260	B																		
	BV																		
	BW																		
280	B																		
	BV																		
	BW																		
300	B																		
	BV																		
	BW																		
320	B																		
	BV																		
	BW																		
340	B																		
	BV																		
	BW																		
360	B																		
	BV																		
	BW																		
380	B																		
	BV																		
	BW																		
400	B																		
	BV																		
	BW																		

1) 12° 2) 17° 3) 22° 4) 27° 5) 32° 6) 37° 7) 42° 8) 47° 9) 52° 10) 57° 11) 62°

SDWB/SDWBV/SDWBW

S 256

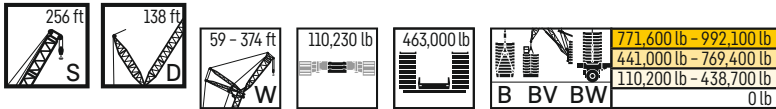

ft	ft	S 256 ft															
		W 236 ft		W 256 ft		W 276 ft		W 295 ft		W 315 ft		W 335 ft		W 354 ft		W 374 ft	
		87°/85	WVmax	87°/85	WVmax	87°/85	WVmax	87°/85	WVmax	87°/85	WVmax	87°/85	WVmax	87°/85	WVmax	87°/85	WVmax
90	B	324.0*	324.0*														
	BV	326.0*	326.0*														
	BW	314.0*	324.0 ⁽¹⁾														
100	B	317.0*	317.0*	288.0*	291.0 ⁽¹⁾	260.0*	260.0*										
	BV	322.0	322.0	291.0	291.0	251.0*	258.0 ⁽¹⁾	227.0*	229.0 ⁽¹⁾	203.0*	203.0*	183.0*	183.0*				
	BW	325.0	326.0 ⁽¹⁾	293.0	293.0												
110	B	312.0	312.0	285.0	285.0	253.0*	260.0 ⁽¹⁾	228.0*	231.0 ⁽¹⁾	203.0*	203.0*	183.0*	183.0*				
	BV	317.0	324.0 ⁽¹⁾	288.0	290.0 ⁽¹⁾	257.0	257.0	230.0	230.0	198.0*	198.0*	180.0*	180.0*	161.0*	161.0*	140.0*	140.0*
	BW	319.0	319.0	289.0	289.0	259.0	259.0	232.0	232.0	199.0*	203.0 ⁽¹⁾	180.0*	181.0 ⁽¹⁾	162.0*	162.0*	141.0*	141.0*
120	B	303.0	303.0	278.0	278.0	251.0	251.0	227.0	227.0	201.0	201.0	176.0*	179.0 ⁽¹⁾	159.0*	160.0 ⁽¹⁾	138.0*	138.0*
	BV	308.0	323.0 ⁽¹⁾	281.0	288.0 ⁽¹⁾	254.0	257.0 ⁽¹⁾	227.0	228.0 ⁽¹⁾	202.0	202.0	178.0	178.0	157.0	157.0	137.0	137.0
	BW	310.0	313.0 ⁽²⁾	283.0	283.0	255.0	255.0	229.0	229.0	202.0	202.0	177.0*	181.0 ⁽¹⁾	159.0*	161.0 ⁽¹⁾	138.0*	139.0 ⁽¹⁾
130	B	292.0	303.0 ⁽²⁾	269.0	272.0 ⁽²⁾	246.0	246.0	222.0	222.0	198.0	198.0	178.0	178.0	160.0	160.0	136.0*	138.0 ⁽¹⁾
	BV	297.0	321.0 ⁽¹⁾	273.0	286.0 ⁽¹⁾	248.0	255.0 ⁽¹⁾	224.0	226.0 ⁽¹⁾	199.0	200.0 ⁽¹⁾	176.0	176.0	156.0	156.0		
	BW	299.0	313.0 ⁽²⁾	275.0	280.0 ⁽²⁾	250.0	250.0	226.0	226.0	200.0	200.0	180.0	180.0	161.0	161.0	136.0*	138.0 ⁽¹⁾
140	B	281.0	304.0 ⁽²⁾	261.0	272.0 ⁽²⁾	239.0	242.0 ⁽²⁾	218.0	218.0	194.0	194.0	176.0	176.0	157.0	157.0	137.0	137.0
	BV	287.0	311.0 ⁽²⁾	265.0	284.0 ⁽¹⁾	242.0	253.0 ⁽¹⁾	219.0	224.0 ⁽¹⁾	196.0	198.0 ⁽¹⁾	173.0	174.0 ⁽¹⁾	154.0	154.0	134.0	134.0
	BW	288.0	313.0 ⁽²⁾	267.0	280.0 ⁽²⁾	244.0	249.0 ⁽²⁾	221.0	222.0 ⁽²⁾	197.0	197.0	177.0	177.0	159.0	159.0	138.0	138.0
150	B	271.0	304.0 ⁽²⁾	250.0	272.0 ⁽²⁾	232.0	242.0 ⁽²⁾	211.0	216.0 ⁽²⁾	190.0	191.0 ⁽²⁾	173.0	173.0	154.0	154.0	135.0	135.0
	BV	276.0	311.0 ⁽²⁾	256.0	278.0 ⁽²⁾	235.0	251.0 ⁽¹⁾	213.0	222.0 ⁽¹⁾	192.0	197.0 ⁽¹⁾	171.0	172.0 ⁽¹⁾	152.0	152.0	132.0	132.0
	BW	278.0	312.0 ⁽²⁾	257.0	280.0 ⁽²⁾	237.0	248.0 ⁽²⁾	216.0	221.0 ⁽²⁾	193.0	195.0 ⁽²⁾	175.0	175.0	156.0	156.0	136.0	136.0
160	B	259.0	300.0 ⁽²⁾	242.0	272.0 ⁽²⁾	224.0	242.0 ⁽²⁾	205.0	215.0 ⁽²⁾	185.0	189.0 ⁽²⁾	170.0	171.0 ⁽²⁾	151.0	151.0	133.0	133.0
	BV	264.0	310.0 ⁽²⁾	246.0	278.0 ⁽²⁾	228.0	247.0 ⁽²⁾	208.0	221.0 ⁽¹⁾	187.0	195.0 ⁽¹⁾	167.0	171.0 ⁽¹⁾	149.0	149.0	130.0	131.0 ⁽¹⁾
	BW	266.0	312.0 ⁽²⁾	248.0	279.0 ⁽²⁾	230.0	248.0 ⁽²⁾	210.0	221.0 ⁽²⁾	189.0	194.0 ⁽²⁾	172.0	173.0 ⁽²⁾	152.0	152.0	134.0	134.0
170	B	248.0	291.0 ⁽²⁾	233.0	269.0 ⁽²⁾	217.0	241.0 ⁽²⁾	198.0	215.0 ⁽²⁾	180.0	189.0 ⁽²⁾	165.0	169.0 ⁽²⁾	147.0	149.0 ⁽²⁾	131.0	131.0
	BV	253.0	309.0 ⁽²⁾	237.0	277.0 ⁽²⁾	220.0	246.0 ⁽²⁾	202.0	218.0 ⁽²⁾	183.0	193.0 ⁽²⁾	163.0	169.0 ⁽¹⁾	146.0	148.0 ⁽²⁾	128.0	129.0 ⁽¹⁾
	BW	255.0	310.0 ⁽²⁾	239.0	278.0 ⁽²⁾	222.0	248.0 ⁽²⁾	203.0	220.0 ⁽²⁾	184.0	194.0 ⁽²⁾	168.0	173.0 ⁽²⁾	149.0	151.0 ⁽²⁾	132.0	133.0 ⁽²⁾
180	B	239.0	284.0 ⁽³⁾	224.0	261.0 ⁽²⁾	209.0	238.0 ⁽²⁾	191.0	215.0 ⁽²⁾	175.0	188.0 ⁽²⁾	161.0	168.0 ⁽²⁾	144.0	148.0 ⁽²⁾	128.0	130.0 ⁽²⁾
	BV	242.0	308.0 ⁽²⁾	227.0	275.0 ⁽²⁾	212.0	245.0 ⁽²⁾	195.0	218.0 ⁽²⁾	177.0	192.0 ⁽²⁾	159.0	168.0 ⁽²⁾	143.0	148.0 ⁽²⁾	125.0	127.0 ⁽¹⁾
	BW	244.0	308.0 ⁽²⁾	229.0	276.0 ⁽²⁾	214.0	246.0 ⁽²⁾	196.0	220.0 ⁽²⁾	179.0	193.0 ⁽²⁾	165.0	172.0 ⁽²⁾	147.0	151.0 ⁽²⁾	130.0	132.0 ⁽²⁾
190	B	230.0	275.0 ⁽³⁾	216.0	255.0 ⁽³⁾	201.0	234.0 ⁽²⁾	185.0	211.0 ⁽²⁾	170.0	188.0 ⁽²⁾	157.0	167.0 ⁽²⁾	141.0	147.0 ⁽²⁾	125.0	129.0 ⁽²⁾
	BV	232.0	306.0 ⁽²⁾	218.0	273.0 ⁽²⁾	203.0	243.0 ⁽²⁾	188.0	216.0 ⁽²⁾	172.0	191.0 ⁽²⁾	155.0	167.0 ⁽²⁾	139.0	147.0 ⁽²⁾	122.0	126.0 ⁽²⁾
	BW	234.0	307.0 ⁽²⁾	220.0	274.0 ⁽²⁾	205.0	244.0 ⁽²⁾	190.0	219.0 ⁽²⁾	174.0	192.0 ⁽²⁾	160.0	171.0 ⁽²⁾	143.0	150.0 ⁽²⁾	127.0	131.0 ⁽²⁾
200	B	211.0	258.0 ⁽⁵⁾	199.0	240.0 ⁽³⁾	186.0	226.0 ⁽²⁾	173.0	202.0 ⁽²⁾	158.0	183.0 ⁽²⁾	146.0	164.0 ⁽²⁾	133.0	145.0 ⁽²⁾	119.0	127.0 ⁽²⁾
	BV	215.0	302.0 ⁽³⁾	201.0	269.0 ⁽²⁾	188.0	239.0 ⁽²⁾	174.0	212.0 ⁽²⁾	161.0	188.0 ⁽²⁾	146.0	164.0 ⁽²⁾	132.0	145.0 ⁽²⁾	115.0	124.0 ⁽²⁾
	BW	218.0	302.0 ⁽³⁾	202.0	270.0 ⁽²⁾	189.0	240.0 ⁽²⁾	176.0	215.0 ⁽²⁾	163.0	189.0 ⁽²⁾	149.0	169.0 ⁽²⁾	137.0	148.0 ⁽²⁾	121.0	129.0 ⁽²⁾
220	B	195.0	240.0 ⁽⁶⁾	183.0	225.0 ⁽⁴⁾	174.0	212.0 ⁽³⁾	161.0	193.0 ⁽²⁾	146.0	178.0 ⁽²⁾	137.0	160.0 ⁽²⁾	125.0	141.0 ⁽²⁾	112.0	123.0 ⁽²⁾
	BV	198.0	293.0 ⁽⁴⁾	186.0	267.0 ⁽³⁾	174.0	237.0 ⁽³⁾	161.0	209.0 ⁽³⁾	149.0	184.0 ⁽²⁾	136.0	160.0 ⁽²⁾	124.0	142.0 ⁽²⁾	108.0	122.0 ⁽²⁾
	BW	199.0	293.0 ⁽⁴⁾	188.0	268.0 ⁽³⁾	176.0	238.0 ⁽³⁾	164.0	211.0 ⁽³⁾	150.0	185.0 ⁽²⁾	140.0	165.0 ⁽²⁾	129.0	145.0 ⁽²⁾	113.0	126.0 ⁽²⁾
240	B	175.0	222.0 ⁽⁸⁾	171.0	212.0 ⁽⁷⁾	159.0	195.0 ⁽⁴⁾	148.0	182.0 ⁽³⁾	137.0	170.0 ⁽³⁾	128.0	155.0 ⁽²⁾	118.0	138.0 ⁽³⁾	102.0	120.0 ⁽²⁾
	BV	176.0	278.0 ⁽⁵⁾	172.0	257.0 ⁽⁴⁾	161.0	233.0 ⁽³⁾	149.0	208.0 ⁽³⁾	137.0	181.0 ⁽³⁾	126.0	156.0 ⁽²⁾	115.0	138.0 ⁽²⁾	100.0	118.0 ⁽²⁾
	BW	177.0	277.0 ⁽⁵⁾	174.0	258.0 ⁽⁴⁾	164.0	233.0 ⁽³⁾	151.0	210.0 ⁽³⁾	139.0	182.0 ⁽³⁾	130.0	161.0 ⁽³⁾	121.0	142.0 ⁽²⁾	104.0	123.0 ⁽²⁾
260	B		203.0 ⁽⁹⁾	152.0	192.0 ⁽⁷⁾	146.0	183.0 ⁽⁷⁾	137.0	171.0 ⁽⁴⁾	128.0	161.0 ⁽⁴⁾	120.0	149.0 ⁽³⁾	110.0	135.0 ⁽³⁾	95.0	117.0 ⁽²⁾
	BV		262.0 ⁽²⁾	153.0	244.0 ⁽³⁾	149.0	225.0 ⁽³⁾	138.0	203.0 ⁽³⁾	127.0	177.0 ⁽³⁾	116.0	153.0 ⁽³⁾	107.0	135.0 ⁽³⁾	93.4	115.0 ⁽²⁾
	BW		262.0 ⁽²⁾	153.0	245.0 ⁽³⁾	150.0	226.0 ⁽³⁾	140.0	204.0 ⁽³⁾	129.0	178.0 ⁽³⁾	121.0	158.0 ⁽³⁾	112.0	139.0 ⁽³⁾	96.9	120.0 ⁽²⁾
280	B		182.0 ⁽¹⁰⁾		177.0 ⁽⁹⁾	131.0	172.0 ⁽⁹⁾	127.0	160.0 ⁽⁷⁾	118.0	150.0 ⁽⁵⁾	112.0	141.0 ⁽⁴⁾	101.0	130.0 ⁽⁵⁾	88.8	114.0 ⁽³⁾
	BV		241.0 ⁽⁵⁾		233.0 ⁽³⁾	132.0	218.0 ⁽⁵⁾	128.0	197.0 ⁽³⁾	119.0	173.0 ⁽³⁾	108.0	149.0 ⁽³⁾	98.2	132.0 ⁽⁵⁾	86.7	111.0 ⁽³⁾
	BW		241.0 ⁽⁵⁾		233.0 ⁽³⁾	133.0	219.0 ⁽⁵⁾	130.0	198.0 ⁽³⁾	121.0	174.0 ⁽³⁾	113.0	153.0 ⁽⁵⁾	103.0	136.0 ⁽⁵⁾	90.9	117.0 ⁽³⁾
300	B		163.0 ⁽¹¹⁾		163.0 ⁽¹⁰⁾		158.0 ⁽⁹⁾	113.0	150.0 ⁽⁸⁾	110.0	141.0 ⁽⁶⁾	103.0	133.0 ⁽⁵⁾	93.1	126.0 ⁽⁴⁾	83.1	109.0 ⁽⁴⁾
	BV		222.0 ⁽⁵⁾		217.0 ⁽⁴⁾		211.0 ⁽³⁾	112.0	192.0 ⁽³⁾	110.0	169.0 ⁽⁴⁾	100.0	145.0 ⁽³⁾	91.5	128.0 ⁽³⁾	80.3	108.0 ⁽³⁾
	BW		223.0 ⁽⁵⁾		217.0 ⁽⁴⁾		211.0 ⁽³⁾	114.0	192.0 ⁽³⁾	113.0	170.0 ⁽⁴⁾	104.0	149.0 ⁽³⁾	95.1	132.0 ⁽³⁾	85.2	113.0 ⁽³⁾
320	B		139.0 ⁽¹¹⁾		145.0 ⁽¹⁰⁾		145.0 ⁽¹⁰⁾		140.0 ⁽⁹⁾	93.9	133.0 ⁽⁷⁾	93.1	126.0 ⁽⁶⁾	87.2	120.0 ⁽⁵⁾	77.6	102.0 ⁽⁴⁾
	BV		205.0 ⁽⁷⁾		200.0 ⁽⁵⁾		197.0 ⁽⁴⁾		186.0 ⁽³⁾	94.8	166.0 ⁽⁴⁾	92.6	142.0 ⁽⁴⁾	84.4	125.0 ⁽⁴⁾	74.8	105.0 ⁽³⁾
	BW		204.0 ⁽⁷⁾		200.0 ⁽⁵⁾		196.0 ⁽⁴⁾		186.0 ⁽³⁾	95.0	167.0 ⁽⁴⁾	95.8	144.0 ⁽³⁾	88.5	129.0 ⁽³⁾	80.0	110.0 ⁽⁴⁾
340	B		113.0 ⁽⁹⁾		123.0 ⁽¹¹⁾		128.0 ⁽¹¹⁾		131.0 ⁽¹⁰⁾		125.0 ⁽⁹⁾	81.9	119.0 ⁽⁷⁾	79.8	113.0 ⁽⁶⁾	72.1	96.9 ⁽⁵⁾
	BV		185.0 ⁽⁹⁾		185.0 ⁽⁷⁾		180.0 ⁽⁵⁾		175.0 ⁽⁴⁾		163.0 ⁽⁴⁾	78.5	139.0 ⁽⁴⁾	78.0	122.0 ⁽⁴⁾	68.7	102.0 ⁽⁴⁾
	BW		184.0 ⁽⁹⁾		185.0 ⁽⁷⁾		180.0 ⁽⁵⁾		176.0 ⁽⁴⁾		164.0 ⁽⁴⁾	82.9	142.0 ⁽⁴⁾	82.4	126.0 ⁽⁴⁾	74.1	107.0 ⁽⁴⁾
360	B		93.0 ⁽⁹⁾		99.4 ⁽⁹⁾		108.0 ⁽¹¹⁾		112.0 ⁽¹⁰⁾		117.0 ⁽¹⁰⁾		111.0 ⁽⁹⁾	68.7	104.0 ⁽⁷⁾	66.2	93.1 ⁽⁴⁾
	BV		161.0 ⁽⁹⁾		165.0 ⁽⁹⁾		163.0 ⁽⁶⁾										

SDWB/SDWBV/SDWBW

S 276

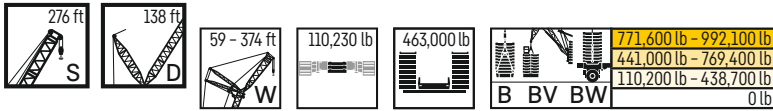

ft		S 276 ft																	
		W 59 ft		W 79 ft		W 98 ft		W 118 ft		W 138 ft		W 158 ft		W 177 ft		W 197 ft		W 217 ft	
		87°/85	WVmax	87°/85	WVmax	87°/85	WVmax	87°/85	WVmax	87°/85	WVmax	87°/85	WVmax	87°/85	WVmax	87°/85	WVmax	87°/85	WVmax
50	B	774.0*	797.0 ⁽¹⁾	705.0*	705.0*														
	BV																		
	BW	782.0*	805.0 ⁽¹⁾	709.0*	709.0*														
60	B	784.0	793.0 ⁽¹⁾	660.0*	673.0 ⁽²⁾	622.0*	635.0 ⁽¹⁾	567.0*	567.0*										
	BV	787.0	803.0 ⁽¹⁾																
	BW	791.0	797.0 ⁽¹⁾	666.0*	681.0 ⁽²⁾	626.0*	640.0 ⁽¹⁾	569.0*	569.0*										
70	B	742.0	789.0 ⁽¹⁾	678.0	681.0 ⁽²⁾	631.0	634.0 ⁽¹⁾	545.0*	566.0 ⁽²⁾	497.0*	505.0 ⁽¹⁾	455.0*	455.0*						
	BV	737.0	803.0 ⁽¹⁾	676.0	704.0 ⁽¹⁾	639.0	643.0 ⁽¹⁾												
	BW	741.0	782.0 ⁽²⁾	678.0	682.0 ⁽²⁾	641.0	645.0 ⁽¹⁾	548.0*	573.0 ⁽¹⁾	500.0*	508.0 ⁽¹⁾	457.0*	457.0*						
80	B	697.0	787.0 ⁽¹⁾	640.0	675.0 ⁽²⁾	599.0	628.0 ⁽¹⁾	551.0	564.0 ⁽¹⁾	504.0	504.0	437.0*	453.0 ⁽¹⁾	398.0*	404.0 ⁽¹⁾	365.0*	365.0*		
	BV	690.0	803.0 ⁽¹⁾	636.0	703.0 ⁽¹⁾	610.0	641.0 ⁽¹⁾	560.0	573.0 ⁽¹⁾	512.0	512.0								
	BW	693.0	783.0 ⁽²⁾	638.0	681.0 ⁽²⁾	612.0	643.0 ⁽¹⁾	562.0	574.0 ⁽¹⁾	514.0	514.0	442.0*	459.0 ⁽¹⁾	401.0*	408.0 ⁽¹⁾	368.0*	368.0*		
90	B	637.0	765.0 ⁽¹⁾	600.0	669.0 ⁽²⁾	563.0	626.0 ⁽¹⁾	522.0	558.0 ⁽¹⁾	480.0	499.0 ⁽¹⁾	444.0	449.0 ⁽¹⁾	405.0	405.0	353.0*	364.0 ⁽¹⁾	320.0*	324.0 ⁽¹⁾
	BV	638.0	802.0 ⁽¹⁾	593.0	701.0 ⁽¹⁾	576.0	640.0 ⁽¹⁾	532.0	570.0 ⁽¹⁾	489.0	509.0 ⁽¹⁾	451.0	458.0 ⁽¹⁾	411.0	411.0				
	BW	639.0	783.0 ⁽²⁾	596.0	680.0 ⁽²⁾	579.0	641.0 ⁽¹⁾	535.0	572.0 ⁽¹⁾	491.0	511.0 ⁽¹⁾	452.0	459.0 ⁽¹⁾	413.0	413.0	355.0*	368.0 ⁽¹⁾	323.0*	327.0 ⁽¹⁾
100	B		716.0 ⁽¹⁾	563.0	660.0 ⁽²⁾	533.0	624.0 ⁽¹⁾	494.0	555.0 ⁽¹⁾	457.0	495.0 ⁽¹⁾	424.0	447.0 ⁽¹⁾	389.0	399.0 ⁽¹⁾	360.0	360.0	327.0	327.0
	BV		802.0 ⁽¹⁾	559.0	684.0 ⁽¹⁾	543.0	638.0 ⁽¹⁾	504.0	568.0 ⁽¹⁾	466.0	506.0 ⁽¹⁾	432.0	455.0 ⁽¹⁾	396.0	407.0 ⁽¹⁾	365.0	367.0 ⁽¹⁾	330.0	330.0
	BW		782.0 ⁽²⁾	563.0	678.0 ⁽²⁾	546.0	639.0 ⁽¹⁾	506.0	570.0 ⁽¹⁾	468.0	508.0 ⁽¹⁾	434.0	457.0 ⁽¹⁾	397.0	398.0 ⁽¹⁾	367.0	367.0	332.0	332.0
110	B		667.0 ⁽¹⁾	518.0	623.0 ⁽⁴⁾	505.0	594.0 ⁽²⁾	468.0	547.0 ⁽¹⁾	433.0	492.0 ⁽¹⁾	405.0	445.0 ⁽¹⁾	374.0	397.0 ⁽¹⁾	347.0	347.0	317.0	317.0
	BV		802.0 ⁽¹⁾	514.0	680.0 ⁽²⁾	511.0	638.0 ⁽¹⁾	477.0	566.0 ⁽¹⁾	443.0	504.0 ⁽¹⁾	413.0	453.0 ⁽¹⁾	380.0	405.0 ⁽¹⁾	352.0	366.0 ⁽¹⁾	321.0	326.0 ⁽¹⁾
	BW		784.0 ⁽²⁾	519.0	680.0 ⁽²⁾	514.0	637.0 ⁽¹⁾	479.0	567.0 ⁽¹⁾	444.0	505.0 ⁽¹⁾	414.0	454.0 ⁽¹⁾	382.0	388.0 ⁽²⁾	353.0	353.0	322.0	322.0
120	B		617.0 ⁽¹⁾		586.0 ⁽⁴⁾	478.0	562.0 ⁽³⁾	444.0	524.0 ⁽²⁾	411.0	478.0 ⁽¹⁾	386.0	442.0 ⁽¹⁾	358.0	395.0 ⁽¹⁾	333.0	342.0 ⁽²⁾	305.0	305.0
	BV		775.0 ⁽²⁾		683.0 ⁽²⁾	485.0	637.0 ⁽¹⁾	450.0	565.0 ⁽¹⁾	420.0	502.0 ⁽¹⁾	393.0	451.0 ⁽¹⁾	364.0	403.0 ⁽¹⁾	339.0	364.0 ⁽¹⁾	310.0	324.0 ⁽¹⁾
	BW		776.0 ⁽²⁾		682.0 ⁽²⁾	487.0	636.0 ⁽¹⁾	452.0	566.0 ⁽¹⁾	422.0	505.0 ⁽¹⁾	395.0	452.0 ⁽¹⁾	365.0	388.0 ⁽²⁾	340.0	349.0 ⁽²⁾	312.0	312.0
130	B		568.0 ⁽¹⁾		551.0 ⁽⁹⁾	459.0	530.0 ⁽⁵⁾	422.0	500.0 ⁽³⁾	391.0	464.0 ⁽²⁾	367.0	425.0 ⁽¹⁾	342.0	394.0 ⁽¹⁾	320.0	342.0 ⁽²⁾	294.0	304.0 ⁽²⁾
	BV		737.0 ⁽⁵⁾		681.0 ⁽²⁾	462.0	637.0 ⁽¹⁾	428.0	565.0 ⁽¹⁾	397.0	502.0 ⁽¹⁾	374.0	450.0 ⁽¹⁾	348.0	401.0 ⁽¹⁾	325.0	362.0 ⁽¹⁾	299.0	323.0 ⁽¹⁾
	BW		735.0 ⁽⁵⁾		679.0 ⁽²⁾	464.0	636.0 ⁽¹⁾	430.0	566.0 ⁽¹⁾	398.0	485.0 ⁽²⁾	376.0	438.0 ⁽¹⁾	349.0	387.0 ⁽²⁾	327.0	348.0 ⁽²⁾	301.0	311.0 ⁽²⁾
140	B		519.0 ⁽¹⁾		518.0 ⁽¹⁰⁾		500.0 ⁽⁷⁾	402.0	474.0 ⁽⁴⁾	373.0	444.0 ⁽³⁾	349.0	415.0 ⁽²⁾	325.0	377.0 ⁽²⁾	306.0	341.0 ⁽²⁾	283.0	304.0 ⁽²⁾
	BV		690.0 ⁽⁶⁾		648.0 ⁽⁴⁾		618.0 ⁽²⁾	406.0	564.0 ⁽¹⁾	376.0	501.0 ⁽¹⁾	355.0	449.0 ⁽¹⁾	331.0	400.0 ⁽¹⁾	311.0	360.0 ⁽¹⁾	288.0	321.0 ⁽¹⁾
	BW		690.0 ⁽⁶⁾		646.0 ⁽⁴⁾		616.0 ⁽²⁾	408.0	565.0 ⁽¹⁾	378.0	486.0 ⁽²⁾	356.0	434.0 ⁽²⁾	333.0	387.0 ⁽²⁾	313.0	348.0 ⁽²⁾	289.0	311.0 ⁽²⁾
150	B		478.0 ⁽⁸⁾		480.0 ⁽¹⁰⁾		469.0 ⁽⁹⁾	389.0	449.0 ⁽⁶⁾	356.0	425.0 ⁽⁴⁾	334.0	401.0 ⁽³⁾	311.0	368.0 ⁽²⁾	293.0	340.0 ⁽²⁾	272.0	303.0 ⁽²⁾
	BV		642.0 ⁽⁸⁾		617.0 ⁽⁶⁾		591.0 ⁽³⁾	388.0	548.0 ⁽²⁾	359.0	500.0 ⁽¹⁾	337.0	448.0 ⁽¹⁾	315.0	399.0 ⁽¹⁾	298.0	358.0 ⁽¹⁾	276.0	309.0 ⁽²⁾
	BW		642.0 ⁽⁷⁾		614.0 ⁽⁶⁾		589.0 ⁽³⁾	391.0	547.0 ⁽²⁾	362.0	487.0 ⁽²⁾	339.0	435.0 ⁽²⁾	317.0	386.0 ⁽²⁾	299.0	347.0 ⁽²⁾	278.0	310.0 ⁽²⁾
160	B		440.0 ⁽⁹⁾		443.0 ⁽¹⁰⁾		443.0 ⁽¹¹⁾		425.0 ⁽⁷⁾	341.0	407.0 ⁽³⁾	321.0	384.0 ⁽⁴⁾	297.0	357.0 ⁽³⁾	280.0	331.0 ⁽²⁾	261.0	303.0 ⁽²⁾
	BV		596.0 ⁽⁸⁾		582.0 ⁽⁷⁾		569.0 ⁽⁵⁾		528.0 ⁽³⁾	343.0	487.0 ⁽²⁾	322.0	445.0 ⁽¹⁾	300.0	398.0 ⁽¹⁾	284.0	356.0 ⁽¹⁾	264.0	308.0 ⁽²⁾
	BW		596.0 ⁽⁸⁾		580.0 ⁽⁷⁾		566.0 ⁽⁵⁾		527.0 ⁽³⁾	344.0	488.0 ⁽²⁾	325.0	435.0 ⁽²⁾	301.0	387.0 ⁽²⁾	285.0	347.0 ⁽²⁾	266.0	310.0 ⁽²⁾
170	B		401.0 ⁽⁹⁾		411.0 ⁽¹⁰⁾		412.0 ⁽¹¹⁾		407.0 ⁽¹⁰⁾	326.0	385.0 ⁽⁵⁾	307.0	368.0 ⁽⁵⁾	284.0	344.0 ⁽³⁾	268.0	322.0 ⁽³⁾	250.0	294.0 ⁽²⁾
	BV		549.0 ⁽⁸⁾		546.0 ⁽⁷⁾		547.0 ⁽⁷⁾		507.0 ⁽⁴⁾	327.0	472.0 ⁽³⁾	307.0	436.0 ⁽²⁾	285.0	387.0 ⁽²⁾	271.0	355.0 ⁽¹⁾	252.0	309.0 ⁽²⁾
	BW		550.0 ⁽⁸⁾		544.0 ⁽⁷⁾		545.0 ⁽⁷⁾		505.0 ⁽⁴⁾	329.0	471.0 ⁽³⁾	309.0	436.0 ⁽²⁾	287.0	387.0 ⁽²⁾	273.0	348.0 ⁽²⁾	253.0	310.0 ⁽²⁾
180	B		363.0 ⁽⁹⁾		380.0 ⁽¹⁰⁾		382.0 ⁽¹⁰⁾		383.0 ⁽¹¹⁾		365.0 ⁽⁸⁾	295.0	351.0 ⁽³⁾	274.0	331.0 ⁽³⁾	257.0	311.0 ⁽⁴⁾	239.0	286.0 ⁽³⁾
	BV		502.0 ⁽⁸⁾		510.0 ⁽⁸⁾		517.0 ⁽⁹⁾		491.0 ⁽⁶⁾		456.0 ⁽⁴⁾	294.0	422.0 ⁽³⁾	274.0	388.0 ⁽²⁾	259.0	348.0 ⁽²⁾	241.0	309.0 ⁽²⁾
	BW		504.0 ⁽⁸⁾		509.0 ⁽⁸⁾		516.0 ⁽⁹⁾		489.0 ⁽⁶⁾		455.0 ⁽⁴⁾	296.0	424.0 ⁽³⁾	276.0	388.0 ⁽²⁾	261.0	348.0 ⁽²⁾	242.0	310.0 ⁽²⁾
190	B				348.0 ⁽¹⁰⁾		354.0 ⁽¹⁰⁾		358.0 ⁽¹¹⁾		348.0 ⁽¹¹⁾	277.0	335.0 ⁽⁷⁾	264.0	319.0 ⁽⁵⁾	248.0	300.0 ⁽²⁾	230.0	279.0 ⁽²⁾
	BV		463.0 ⁽⁷⁾		475.0 ⁽⁸⁾		485.0 ⁽⁹⁾		473.0 ⁽⁸⁾		439.0 ⁽⁵⁾	278.0	409.0 ⁽³⁾	262.0	377.0 ⁽²⁾	249.0	349.0 ⁽²⁾	230.0	310.0 ⁽²⁾
	BW				475.0 ⁽⁸⁾		484.0 ⁽¹⁰⁾		471.0 ⁽⁸⁾		437.0 ⁽⁵⁾	280.0	409.0 ⁽³⁾	265.0	377.0 ⁽²⁾	249.0	349.0 ⁽²⁾	232.0	311.0 ⁽²⁾
200	B				317.0 ⁽¹⁰⁾		327.0 ⁽¹⁰⁾		334.0 ⁽¹⁰⁾		331.0 ⁽¹¹⁾		322.0 ⁽⁹⁾	254.0	304.0 ⁽⁶⁾	239.0	288.0 ⁽⁵⁾	222.0	271.0 ⁽²⁾
	BV		433.0 ⁽⁷⁾		439.0 ⁽⁹⁾		452.0 ⁽⁹⁾		453.0 ⁽¹⁰⁾		425.0 ⁽⁷⁾		397.0 ⁽⁵⁾	252.0	368.0 ⁽⁵⁾	238.0	341.0 ⁽²⁾	222.0	310.0 ⁽²⁾
	BW				440.0 ⁽⁹⁾		452.0 ⁽¹⁰⁾		449.0 ⁽¹⁰⁾		424.0 ⁽⁷⁾		396.0 ⁽⁵⁾	253.0	368.0 ⁽⁵⁾	239.0	341.0 ⁽²⁾	223.0	311.0 ⁽²⁾
220	B				272.0 ⁽¹⁰⁾		287.0 ⁽¹⁰⁾		287.0 ⁽¹⁰⁾		290.0 ⁽¹¹⁾		293.0 ⁽¹¹⁾		278.0 ⁽⁹⁾	222.0	267.0 ⁽⁷⁾	206.0	251.0 ⁽⁴⁾
	BV		373.0 ⁽⁷⁾		388.0 ⁽¹⁰⁾		399.0 ⁽¹⁰⁾		388.0 ⁽¹⁰⁾		393.0 ⁽¹⁰⁾		371.0 ⁽⁷⁾		347.0 ⁽⁵⁾	219.0	325.0 ⁽⁴⁾	204.0	299.0 ⁽³⁾
	BW				388.0 ⁽¹⁰⁾		398.0 ⁽¹⁰⁾		398.0 ⁽¹⁰⁾		391.0 ⁽¹⁰⁾		372.0 ⁽⁷⁾		346.0 ⁽⁵⁾	221.0	325.0 ⁽⁴⁾	205.0	299.0 ⁽³⁾
240	B				226.0 ⁽⁸⁾		240.0 ⁽¹⁰⁾		240.0 ⁽¹⁰⁾		249.0 ⁽⁹⁾		257.0 ⁽¹⁰⁾		256.0 ⁽¹¹⁾		247.0 ⁽⁹⁾	189.0	233.0 ⁽⁵⁾
	BV		319.0 ⁽⁵⁾		336.0 ⁽⁸⁾		346.0 ⁽⁸⁾		336.0 ⁽⁸⁾		350.0 ⁽¹⁰⁾		343.0 ⁽⁹⁾		326.0 ⁽⁷⁾		307.0 ⁽⁶⁾	188.0	285.0 ⁽³⁾
	BW				337.0 ⁽⁸⁾		346.0 ⁽¹⁰⁾		346.0 ⁽¹⁰⁾		349.0 ⁽¹⁰⁾		342.0 ⁽⁹⁾		326.0 ⁽⁷⁾		307.0 ⁽⁶⁾	189.0	285.0 ⁽⁴⁾
260	B				186.0 ⁽⁸⁾		199.0 ⁽⁸⁾		199.0 ⁽⁸⁾		208.0 ⁽¹⁰⁾		222.0 ⁽¹⁰⁾		230.0 ⁽¹¹⁾		229.0 ⁽¹¹⁾		217.0 ⁽¹⁰⁾
	BV		271.0 ⁽⁵⁾		290.0 ⁽⁸⁾		290.0 ⁽⁸⁾		301.0 ⁽⁸⁾		307.0 ⁽¹⁰⁾		310.0 ⁽⁹⁾		301.0 ⁽⁸⁾		289.0 ⁽²⁾		271.0 ⁽³⁾
	BW				291.0 ⁽⁸⁾														

SDWB/SDWBV/SDWBW

S 276

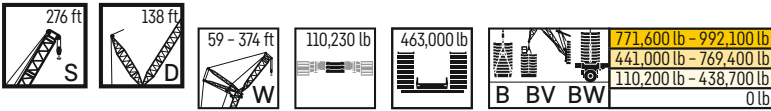

		S 276 ft															
		W 236 ft		W 256 ft		W 276 ft		W 295 ft		W 315 ft		W 335 ft		W 354 ft		W 374 ft	
		87°/85	WVmax	87°/85	WVmax	87°/85	WVmax	87°/85	WVmax	87°/85	WVmax	87°/85	WVmax	87°/85	WVmax	87°/85	WVmax
90	B	293.0*	293.0*														
	BV BW	294.0* 284.0*	294.0* 291.0 ⁽¹⁾														
100	B																
	BV BW	286.0* 290.0	294.0 ⁽¹⁾ 290.0	257.0*	261.0 ⁽¹⁾	232.0*	233.0*										
110	B																
	BV BW	293.0 294.0	294.0 ⁽¹⁾ 294.0	249.0*	259.0 ⁽¹⁾	226.0*	231.0*	203.0*	205.0 ⁽¹⁾	185.0*	185.0*						
120	B																
	BV BW	281.0 285.0	281.0 292.0 ⁽¹⁾	255.0	260.0 ⁽¹⁾	231.0	233.0	197.0*	205.0 ⁽¹⁾	181.0*	181.0*	162.0*	163.0 ⁽¹⁾	144.0*	144.0*	123.0*	123.0*
130	B																
	BV BW	272.0 276.0	274.0 ⁽²⁾ 290.0 ⁽¹⁾	247.0	258.0 ⁽¹⁾	226.0	227.0	203.0	205.0 ⁽¹⁾	185.0	183.0	158.0*	163.0 ⁽¹⁾	140.0*	143.0 ⁽¹⁾	124.0*	125.0 ⁽¹⁾
140	B																
	BV BW	263.0 267.0	274.0 ⁽²⁾ 289.0 ⁽¹⁾	239.0	257.0 ⁽¹⁾	219.0	229.0 ⁽¹⁾	198.0	204.0 ⁽¹⁾	181.0	179.0	162.0	164.0	143.0	141.0	122.0*	125.0 ⁽¹⁾
150	B																
	BV BW	258.0 259.0	287.0 ⁽¹⁾ 278.0 ⁽²⁾	236.0	247.0 ⁽²⁾	215.0	221.0 ⁽²⁾	195.0	203.0 ⁽¹⁾	175.0	179.0 ⁽¹⁾	156.0	157.0 ⁽¹⁾	138.0	139.0 ⁽¹⁾	120.0	120.0
160	B																
	BV BW	244.0 248.0	274.0 ⁽²⁾ 284.0 ⁽¹⁾	237.0	246.0 ⁽²⁾	206.0	226.0 ⁽¹⁾	187.0	201.0 ⁽¹⁾	172.0	171.0	154.0	156.0 ⁽¹⁾	138.0	136.0	122.0	119.0 ⁽¹⁾
170	B																
	BV BW	235.0 238.0	274.0 ⁽²⁾ 282.0 ⁽¹⁾	217.0	245.0 ⁽²⁾	198.0	219.0 ⁽²⁾	182.0	200.0 ⁽¹⁾	168.0	166.0	149.0	155.0 ⁽¹⁾	135.0	136.0 ⁽¹⁾	120.0	117.0 ⁽¹⁾
180	B																
	BV BW	226.0 227.0	265.0 ⁽²⁾ 279.0 ⁽¹⁾	209.0	245.0 ⁽²⁾	192.0	218.0 ⁽²⁾	176.0	194.0 ⁽²⁾	163.0	175.0 ⁽¹⁾	145.0	153.0 ⁽¹⁾	132.0	135.0 ⁽¹⁾	117.0	116.0 ⁽¹⁾
190	B																
	BV BW	217.0 218.0	259.0 ⁽²⁾ 277.0 ⁽¹⁾	200.0	245.0 ⁽²⁾	185.0	218.0 ⁽²⁾	171.0	193.0 ⁽²⁾	158.0	171.0 ⁽²⁾	141.0	149.0 ⁽²⁾	129.0	133.0 ⁽²⁾	114.0	115.0 ⁽¹⁾
200	B																
	BV BW	208.0 208.0	252.0 ⁽²⁾ 277.0 ⁽¹⁾	192.0	244.0 ⁽²⁾	179.0	217.0 ⁽²⁾	165.0	193.0 ⁽²⁾	153.0	170.0 ⁽²⁾	137.0	149.0 ⁽²⁾	125.0	131.0 ⁽²⁾	111.0	110.0 ⁽²⁾
220	B																
	BV BW	193.0 193.0	237.0 ⁽³⁾ 272.0 ⁽¹⁾	178.0	244.0 ⁽²⁾	166.0	216.0 ⁽²⁾	152.0	183.0 ⁽²⁾	142.0	167.0 ⁽²⁾	129.0	147.0 ⁽²⁾	118.0	132.0 ⁽²⁾	103.0	110.0 ⁽²⁾
240	B																
	BV BW	180.0 177.0	222.0 ⁽⁴⁾ 264.0 ⁽³⁾	166.0	240.0 ⁽³⁾	154.0	212.0 ⁽³⁾	141.0	189.0 ⁽²⁾	135.0	166.0 ⁽²⁾	121.0	145.0 ⁽²⁾	111.0	127.0 ⁽²⁾	96.5	109.0 ⁽²⁾
260	B																
	BV BW	164.0 166.0	252.0 ⁽⁴⁾ 253.0 ⁽⁴⁾	151.0	232.0 ⁽⁴⁾	141.0	210.0 ⁽³⁾	130.0	188.0 ⁽³⁾	120.0	165.0 ⁽²⁾	109.0	142.0 ⁽²⁾	99.2	125.0 ⁽²⁾	87.9	107.0 ⁽²⁾
280	B																
	BV BW	189.0 241.0	237.0 ⁽⁵⁾ 241.0 ⁽⁴⁾	178.0	222.0 ⁽⁴⁾	168.0	218.0 ⁽²⁾	155.0	192.0 ⁽²⁾	144.0	172.0 ⁽²⁾	132.0	150.0 ⁽²⁾	121.0	134.0 ⁽²⁾	106.0	115.0 ⁽²⁾
300	B																
	BV BW	175.0 229.0	237.0 ⁽⁵⁾ 229.0 ⁽⁴⁾	166.0 ⁽¹⁰⁾	212.0 ⁽⁴⁾	155.0	215.0 ⁽⁴⁾	143.0	177.0 ⁽⁴⁾	123.0	156.0 ⁽⁴⁾	102.0	139.0 ⁽⁴⁾	87.5	120.0 ⁽³⁾	73.5	102.0 ⁽³⁾
320	B																
	BV BW	159.0 216.0	237.0 ⁽⁵⁾ 203.0 ⁽⁴⁾	154.0 ⁽⁸⁾	203.0 ⁽⁴⁾	146.0 ⁽⁸⁾	187.0 ⁽⁴⁾	132.0	170.0 ⁽⁴⁾	98.2	151.0 ⁽⁴⁾	89.7	131.0 ⁽⁴⁾	81.9	115.0 ⁽⁴⁾	72.7	106.0 ⁽³⁾
340	B																
	BV BW	137.0 199.0	237.0 ⁽⁵⁾ 199.0 ⁽⁶⁾	140.0 ⁽¹¹⁾	192.0 ⁽⁶⁾	137.0 ⁽¹⁰⁾	180.0 ⁽⁵⁾	130.0 ⁽⁸⁾	163.0 ⁽⁵⁾	89.5	146.0 ⁽⁴⁾	84.2	128.0 ⁽⁴⁾	70.6	113.0 ⁽⁴⁾	67.6	95.1 ⁽⁵⁾
360	B																
	BV BW	115.0 184.0	237.0 ⁽⁵⁾ 184.0 ⁽⁹⁾	119.0 ⁽¹¹⁾	177.0 ⁽⁷⁾	125.0 ⁽¹¹⁾	173.0 ⁽⁵⁾	123.0 ⁽¹⁰⁾	157.0 ⁽⁵⁾	90.3	144.0 ⁽⁵⁾	77.0	128.0 ⁽⁵⁾	72.0	118.0 ⁽⁴⁾	63.3	90.8 ⁽⁵⁾
380	B																
	BV BW	92.3 161.0	237.0 ⁽⁵⁾ 161.0 ⁽⁹⁾	99.2 ⁽¹¹⁾	165.0 ⁽⁹⁾	106.0 ⁽¹¹⁾	161.0 ⁽⁷⁾	111.0 ⁽¹¹⁾	152.0 ⁽⁶⁾	81.0	144.0 ⁽⁵⁾	77.0	128.0 ⁽⁵⁾	64.0	110.0 ⁽⁴⁾	57.0	92.4 ⁽⁴⁾
400	B																
	BV BW	72.7 138.0	237.0 ⁽⁵⁾ 139.0 ⁽⁹⁾	77.1 ⁽⁹⁾	143.0 ⁽⁹⁾	86.1 ⁽¹¹⁾	148.0 ⁽⁷⁾	91.7 ⁽¹¹⁾	144.0 ⁽⁷⁾	80.3	134.0 ⁽⁶⁾	72.2	128.0 ⁽⁵⁾	64.0	115.0 ⁽⁴⁾	57.0	92.4 ⁽⁴⁾
420	B																
	BV BW	52.8 116.0	237.0 ⁽⁵⁾ 116.0 ⁽⁷⁾	58.4 ⁽⁹⁾	122.0 ⁽⁹⁾	64.6 ⁽⁹⁾	128.0 ⁽⁹⁾	72.1 ⁽¹¹⁾	130.0 ⁽⁹⁾	66.6	134.0 ⁽⁶⁾	59.9	124.0 ⁽⁵⁾	55.0	119.0 ⁽⁶⁾	49.4	81.7 ⁽⁷⁾
440	B																
	BV BW	36.7 96.7	237.0 ⁽⁵⁾ 97.2 ⁽⁷⁾	39.3 ⁽⁷⁾	101.0 ⁽⁷⁾	47.2 ⁽⁹⁾	108.0 ⁽⁹⁾	51.3 ⁽⁹⁾	112.0 ⁽⁹⁾	62.1 ⁽¹¹⁾	113.0 ⁽⁹⁾	66.6 ⁽¹¹⁾	113.0 ⁽⁷⁾	71.1 ⁽¹¹⁾	88.7 ⁽⁵⁾	71.2 ⁽¹⁰⁾	88.7 ⁽⁵⁾
460	B																
	BV BW																
480	B																
	BV BW																
500	B																
	BV BW																
520	B																
	BV BW																
540	B																
	BV BW																
560	B																
	BV BW																
580	B																
	BV BW																

1) 12° 2) 17° 3) 22° 4) 27° 5) 32° 6) 37° 7) 42° 8) 47° 9) 52° 10) 57° 11) 62°

SDWB/SDWBV/SDWBW

S 295

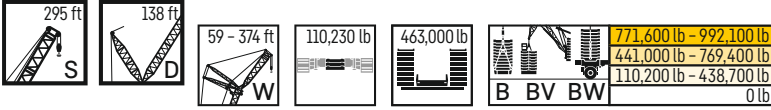

ft	B BV BW	S 295 ft																	
		W 59 ft		W 79 ft		W 98 ft		W 118 ft		W 138 ft		W 158 ft		W 177 ft		W 197 ft		W 217 ft	
		87°/85	WVmax	87°/85	WVmax	87°/85	WVmax	87°/85	WVmax	87°/85	WVmax	87°/85	WVmax	87°/85	WVmax	87°/85	WVmax	87°/85	WVmax
50	B	691.0*	703.0 ⁽¹⁾	616.0*	616.0*														
	BV	695.0*	710.0 ⁽¹⁾																
	BW	694.0*	698.0 ⁽¹⁾	589.0*	597.0 ⁽²⁾	556.0*	563.0 ⁽¹⁾	504.0*	504.0*										
60	B	700.0*	705.0 ⁽¹⁾																
	BV	704.0*	704.0*	594.0*	609.0 ⁽¹⁾	558.0*	566.0 ⁽¹⁾	506.0*	506.0*										
	BW	659.0*	697.0 ⁽¹⁾	602.0*	602.0*	563.0*	563.0*	485.0*	500.0 ⁽¹⁾	445.0*	448.0 ⁽¹⁾	405.0*	405.0*						
70	B	658.0*	697.0 ⁽¹⁾	603.0*	618.0 ⁽¹⁾	568.0*	568.0*												
	BV	661.0*	685.0 ⁽²⁾	605.0*	605.0*	570.0*	570.0*	488.0*	506.0 ⁽¹⁾	447.0*	451.0 ⁽¹⁾	407.0*	407.0*						
	BW	618.0*	696.0 ⁽¹⁾	568.0*	598.0 ⁽²⁾	534.0*	555.0 ⁽¹⁾	490.0*	496.0 ⁽¹⁾	449.0*	449.0*	390.0*	399.0 ⁽¹⁾	356.0*	360.0 ⁽¹⁾	326.0*	326.0*		
80	B	617.0*	690.0 ⁽¹⁾	568.0*	610.0 ⁽¹⁾	542.0*	560.0 ⁽¹⁾	497.0*	503.0 ⁽¹⁾	453.0*	453.0*								
	BV	621.0*	679.0 ⁽²⁾	571.0*	596.0 ⁽²⁾	545.0*	563.0 ⁽¹⁾	499.0*	505.0 ⁽¹⁾	455.0*	455.0*	392.0*	404.0 ⁽¹⁾	358.0*	362.0 ⁽¹⁾	327.0*	327.0*		
	BW	586.0*	692.0 ⁽¹⁾	532.0*	596.0 ⁽²⁾	505.0*	552.0 ⁽¹⁾	466.0*	492.0 ⁽¹⁾	430.0*	440.0 ⁽¹⁾	393.0*	397.0 ⁽¹⁾	342.0*	357.0 ⁽¹⁾	314.0*	322.0 ⁽¹⁾	288.0*	290.0 ⁽¹⁾
90	B	583.0*	683.0 ⁽¹⁾	530.0*	601.0 ⁽¹⁾	513.0*	553.0 ⁽¹⁾	472.0*	495.0 ⁽¹⁾	434.0*	444.0 ⁽¹⁾	398.0*	400.0 ⁽¹⁾	363.0*	363.0*				
	BV	587.0*	672.0 ⁽²⁾	534.0*	589.0 ⁽²⁾	516.0*	556.0 ⁽¹⁾	476.0*	498.0 ⁽¹⁾	436.0*	447.0 ⁽¹⁾	399.0*	402.0 ⁽¹⁾	346.0*	361.0 ⁽¹⁾	317.0*	324.0 ⁽¹⁾	289.0*	291.0 ⁽¹⁾
	BW	656.0 ⁽³⁾	680.0 ⁽¹⁾	503.0*	595.0 ⁽²⁾	477.0*	549.0 ⁽¹⁾	440.0*	490.0 ⁽¹⁾	409.0*	438.0 ⁽¹⁾	378.0*	391.0 ⁽¹⁾	347.0*	347.0*	319.0*	319.0*	278.0*	287.0 ⁽¹⁾
100	B	660.0 ⁽¹⁾	680.0 ⁽¹⁾	501.0*	595.0 ⁽¹⁾	484.0*	545.0 ⁽¹⁾	448.0*	488.0 ⁽¹⁾	414.0*	438.0 ⁽¹⁾	381.0*	395.0 ⁽¹⁾	350.0*	356.0 ⁽¹⁾	321.0*	321.0*	280.0*	290.0 ⁽¹⁾
	BV	666.0 ⁽²⁾	666.0 ⁽²⁾	504.0*	582.0 ⁽²⁾	488.0*	548.0 ⁽¹⁾	450.0*	491.0 ⁽¹⁾	417.0*	441.0 ⁽¹⁾	384.0*	397.0 ⁽¹⁾	352.0*	353.0 ⁽¹⁾	323.0*	323.0*	280.0*	290.0 ⁽¹⁾
	BW	618.0 ⁽⁴⁾	677.0 ⁽¹⁾	477.0*	573.0 ⁽²⁾	451.0*	534.0 ⁽²⁾	419.0*	488.0 ⁽¹⁾	388.0*	436.0 ⁽¹⁾	362.0*	390.0 ⁽¹⁾	334.0*	336.0 ⁽¹⁾	307.0*	307.0*	283.0*	283.0*
110	B	677.0 ⁽¹⁾	677.0 ⁽¹⁾	470.0*	593.0 ⁽¹⁾	457.0*	542.0 ⁽¹⁾	424.0*	480.0 ⁽¹⁾	394.0*	432.0 ⁽¹⁾	365.0*	389.0 ⁽¹⁾	336.0*	351.0 ⁽¹⁾	310.0*	317.0 ⁽¹⁾	284.0*	287.0 ⁽¹⁾
	BV	663.0 ⁽²⁾	663.0 ⁽²⁾	474.0*	578.0 ⁽²⁾	459.0*	544.0 ⁽¹⁾	427.0*	484.0 ⁽¹⁾	396.0*	435.0 ⁽¹⁾	367.0*	391.0 ⁽¹⁾	338.0*	342.0 ⁽¹⁾	311.0*	312.0 ⁽¹⁾	285.0*	285.0*
	BW	582.0 ⁽¹⁾	672.0 ⁽¹⁾		545.0 ⁽²⁾	430.0*	512.0 ⁽³⁾	395.0*	471.0 ⁽²⁾	370.0*	432.0 ⁽¹⁾	343.0*	389.0 ⁽¹⁾	321.0*	336.0 ⁽¹⁾	295.0*	299.0 ⁽²⁾	273.0*	273.0*
120	B	661.0 ⁽²⁾	661.0 ⁽²⁾		591.0 ⁽¹⁾	434.0*	541.0 ⁽¹⁾	401.0*	479.0 ⁽¹⁾	375.0*	426.0 ⁽¹⁾	349.0*	384.0 ⁽¹⁾	323.0*	347.0 ⁽¹⁾	298.0*	313.0 ⁽¹⁾	274.0*	283.0 ⁽¹⁾
	BV	661.0 ⁽²⁾	661.0 ⁽²⁾		577.0 ⁽²⁾	437.0*	543.0 ⁽¹⁾	403.0*	481.0 ⁽¹⁾	377.0*	427.0 ⁽¹⁾	351.0*	386.0 ⁽¹⁾	325.0*	337.0 ⁽²⁾	300.0*	304.0 ⁽²⁾	276.0*	276.0*
	BW	544.0 ⁽¹⁾	640.0 ⁽¹⁾		517.0 ⁽²⁾	413.0*	488.0 ⁽³⁾	377.0*	453.0 ⁽³⁾	351.0*	418.0 ⁽²⁾	328.0*	381.0 ⁽¹⁾	306.0*	335.0 ⁽²⁾	284.0*	299.0 ⁽²⁾	263.0*	269.0 ⁽²⁾
130	B	640.0 ⁽¹⁾	640.0 ⁽¹⁾		585.0 ⁽¹⁾	413.0*	540.0 ⁽¹⁾	381.0*	478.0 ⁽¹⁾	355.0*	426.0 ⁽¹⁾	332.0*	380.0 ⁽¹⁾	309.0*	342.0 ⁽¹⁾	286.0*	309.0 ⁽¹⁾	265.0*	279.0 ⁽¹⁾
	BV	634.0 ⁽⁴⁾	634.0 ⁽⁴⁾		575.0 ⁽²⁾	417.0*	541.0 ⁽¹⁾	384.0*	480.0 ⁽¹⁾	357.0*	415.0 ⁽¹⁾	334.0*	378.0 ⁽¹⁾	311.0*	334.0 ⁽²⁾	288.0*	301.0 ⁽²⁾	267.0*	272.0 ⁽¹⁾
	BW	506.0 ⁽¹⁾	608.0 ⁽¹⁾		487.0 ⁽¹⁾		533.0 ⁽¹⁾	361.0*	478.0 ⁽¹⁾	336.0*	425.0 ⁽¹⁾	315.0*	379.0 ⁽¹⁾	295.0*	339.0 ⁽¹⁾	275.0*	305.0 ⁽¹⁾	255.0*	276.0 ⁽¹⁾
140	B	608.0 ⁽¹⁾	608.0 ⁽¹⁾		562.0 ⁽¹⁾		533.0 ⁽¹⁾	364.0*	479.0 ⁽¹⁾	339.0*	413.0 ⁽²⁾	318.0*	367.0 ⁽²⁾	297.0*	331.0 ⁽²⁾	277.0*	298.0 ⁽²⁾	256.0*	269.0 ⁽²⁾
	BV	599.0 ⁽⁸⁾	599.0 ⁽⁸⁾		559.0 ⁽²⁾		533.0 ⁽¹⁾	364.0*	479.0 ⁽¹⁾	339.0*	413.0 ⁽²⁾	318.0*	367.0 ⁽²⁾	297.0*	331.0 ⁽²⁾	277.0*	298.0 ⁽²⁾	256.0*	269.0 ⁽²⁾
	BW		460.0 ⁽⁶⁾		540.0 ⁽¹⁾		440.0 ⁽⁶⁾	348.0*	416.0 ⁽²⁾	320.0*	386.0 ⁽⁴⁾	298.0*	359.0 ⁽²⁾	279.0*	332.0 ⁽²⁾	261.0*	300.0 ⁽²⁾	243.0*	269.0 ⁽²⁾
150	B		579.0 ⁽⁹⁾		540.0 ⁽¹⁾		514.0 ⁽²⁾	346.0*	471.0 ⁽¹⁾	321.0*	424.0 ⁽⁴⁾	300.0*	378.0 ⁽¹⁾	281.0*	338.0 ⁽¹⁾	263.0*	304.0 ⁽¹⁾	245.0*	273.0 ⁽¹⁾
	BV		579.0 ⁽⁹⁾		537.0 ⁽²⁾		514.0 ⁽²⁾	349.0*	472.0 ⁽¹⁾	324.0*	413.0 ⁽²⁾	301.0*	368.0 ⁽²⁾	284.0*	328.0 ⁽²⁾	266.0*	295.0 ⁽²⁾	246.0*	267.0 ⁽²⁾
	BW				434.0 ⁽¹⁰⁾		420.0 ⁽¹⁾		395.0 ⁽²⁾	307.0*	371.0 ⁽²⁾	286.0*	348.0 ⁽²⁾	267.0*	321.0 ⁽³⁾	249.0*	296.0 ⁽²⁾	233.0*	270.0 ⁽²⁾
160	B		548.0 ⁽⁹⁾		517.0 ⁽¹⁾		495.0 ⁽⁴⁾		457.0 ⁽²⁾	306.0*	416.0 ⁽¹⁾	286.0*	377.0 ⁽¹⁾	268.0*	337.0 ⁽¹⁾	251.0*	302.0 ⁽¹⁾	235.0*	271.0 ⁽¹⁾
	BV		548.0 ⁽⁹⁾		514.0 ⁽²⁾		494.0 ⁽⁴⁾		457.0 ⁽²⁾	309.0*	414.0 ⁽²⁾	289.0*	368.0 ⁽²⁾	270.0*	328.0 ⁽²⁾	253.0*	293.0 ⁽²⁾	237.0*	264.0 ⁽²⁾
	BW				405.0 ⁽¹⁰⁾		396.0 ⁽¹⁾		375.0 ⁽¹⁾	298.0*	356.0 ⁽⁴⁾	274.0*	337.0 ⁽²⁾	255.0*	310.0 ⁽²⁾	239.0*	289.0 ⁽²⁾	224.0*	266.0 ⁽²⁾
170	B		517.0 ⁽⁹⁾		494.0 ⁽¹⁾		475.0 ⁽⁶⁾		442.0 ⁽¹⁾	294.0*	408.0 ⁽²⁾	273.0*	368.0 ⁽²⁾	255.0*	336.0 ⁽¹⁾	240.0*	301.0 ⁽¹⁾	225.0*	270.0 ⁽¹⁾
	BV		517.0 ⁽⁹⁾		492.0 ⁽²⁾		474.0 ⁽⁶⁾		442.0 ⁽¹⁾	297.0*	408.0 ⁽²⁾	276.0*	369.0 ⁽²⁾	257.0*	328.0 ⁽²⁾	241.0*	293.0 ⁽²⁾	227.0*	262.0 ⁽²⁾
	BW				376.0 ⁽¹⁰⁾		373.0 ⁽¹⁾		360.0 ⁽¹⁾		340.0 ⁽⁴⁾	264.0*	324.0 ⁽³⁾	244.0*	300.0 ⁽²⁾	230.0*	281.0 ⁽²⁾	216.0*	260.0 ⁽²⁾
180	B		486.0 ⁽⁹⁾		472.0 ⁽¹⁾		461.0 ⁽⁹⁾		427.0 ⁽¹⁾		396.0 ⁽²⁾	261.0*	364.0 ⁽²⁾	244.0*	328.0 ⁽²⁾	229.0*	300.0 ⁽¹⁾	215.0*	269.0 ⁽¹⁾
	BV		486.0 ⁽⁹⁾		470.0 ⁽²⁾		460.0 ⁽⁹⁾		427.0 ⁽¹⁾		397.0 ⁽²⁾	264.0*	365.0 ⁽²⁾	246.0*	329.0 ⁽²⁾	231.0*	293.0 ⁽²⁾	217.0*	263.0 ⁽²⁾
	BW				346.0 ⁽¹⁰⁾		347.0 ⁽¹⁰⁾		343.0 ⁽¹⁾		326.0 ⁽¹⁰⁾	255.0*	311.0 ⁽³⁾	236.0*	289.0 ⁽³⁾	221.0*	274.0 ⁽²⁾	206.0*	254.0 ⁽²⁾
190	B		455.0 ⁽⁹⁾		449.0 ⁽¹⁾		441.0 ⁽¹⁰⁾		412.0 ⁽¹⁾		385.0 ⁽²⁾	252.0*	356.0 ⁽²⁾	234.0*	326.0 ⁽²⁾	220.0*	293.0 ⁽²⁾	205.0*	267.0 ⁽¹⁾
	BV		455.0 ⁽⁹⁾		447.0 ⁽²⁾		440.0 ⁽¹⁰⁾		413.0 ⁽¹⁾		385.0 ⁽²⁾	253.0*	357.0 ⁽²⁾	236.0*	326.0 ⁽²⁾	222.0*	293.0 ⁽²⁾	207.0*	263.0 ⁽¹⁾
	BW				316.0 ⁽¹⁰⁾		322.0 ⁽¹⁰⁾		326.0 ⁽¹⁰⁾		314.0 ⁽¹⁾		294.0 ⁽⁴⁾	228.0*	278.0 ⁽³⁾	212.0*	265.0 ⁽²⁾	197.0*	248.0 ⁽²⁾
200	B		426.0 ⁽⁷⁾		426.0 ⁽¹⁾		419.0 ⁽¹⁰⁾		397.0 ⁽¹⁾		374.0 ⁽²⁾		348.0 ⁽²⁾	224.0*	320.0 ⁽²⁾	210.0*	291.0 ⁽²⁾	197.0*	261.0 ⁽²⁾
	BV		426.0 ⁽⁷⁾		424.0 ⁽⁴⁾		418.0 ⁽¹⁰⁾		398.0 ⁽¹⁾		374.0 ⁽²⁾		349.0 ⁽²⁾	226.0*	320.0 ⁽²⁾	213.0*	292.0 ⁽²⁾	198.0*	263.0 ⁽²⁾
	BW				271.0 ⁽¹⁰⁾		282.0 ⁽¹⁰⁾		282.0 ⁽¹⁰⁾		281.0 ⁽¹⁾		273.0 ⁽¹⁾		257.0 ⁽⁵⁾	196.0*	246.0 ⁽⁴⁾	184.0*	233.0 ⁽³⁾
220	B		371.0 ⁽⁷⁾		375.0 ⁽¹⁰⁾		364.0 ⁽¹⁰⁾		351.0 ⁽²⁾		351.0 ⁽²⁾		332.0 ⁽²⁾		309.0 ⁽²⁾	193.0*	284.0 ⁽²⁾	181.0*	257.0 ⁽²⁾
	BV		371.0 ⁽⁷⁾		375.0 ⁽¹⁰⁾		364.0 ⁽¹⁰⁾		351.0 ⁽²⁾		351.0 ⁽²⁾		332.0 ⁽²⁾		309.0 ⁽²⁾	195.0*	284.0 ⁽²⁾	183.0*	258.0 ⁽²⁾
	BW				224.0 ⁽⁸⁾		237.0 ⁽¹⁰⁾		237.0 ⁽¹⁰⁾		243.0 ⁽¹⁰⁾		249.0 ⁽¹⁾		240.0 ⁽¹⁾		228.0 ⁽⁶⁾	172.0*	216.0 ⁽⁴⁾
240	B		315.0 ⁽⁵⁾		331.0 ⁽⁸⁾		331.0 ⁽⁸⁾		331.0 ⁽⁸⁾		324.0 ⁽³⁾		315.0 ⁽²⁾		298.0 ⁽²⁾		277.0 ⁽²⁾	167.0*	251.0 ⁽²⁾
	BV		315.0 ⁽⁵⁾		332.0 ⁽⁸⁾		332.0 ⁽⁸⁾		331.0 ⁽⁸⁾		325.0 ⁽³⁾		316.0 ⁽²⁾		297.0 ⁽²⁾		276.0 ⁽²⁾	170.0*	252.0 ⁽²⁾
	BW				189.0 ⁽⁸⁾		196.0 ⁽⁸⁾		196.0 ⁽⁸⁾		207.0 ⁽¹⁰⁾		215.0 ⁽¹⁰⁾		222.0 ⁽¹⁾		211.0 ⁽⁸⁾		199.0 ⁽⁵⁾
260	B		276.0 ⁽⁵⁾		288.0 ⁽⁸⁾		288.0 ⁽⁸⁾		294.0 ⁽⁸⁾		295.0 ⁽⁴⁾		289.0 ⁽³⁾						

SDWB/SDWBV/SDWBW

S 295

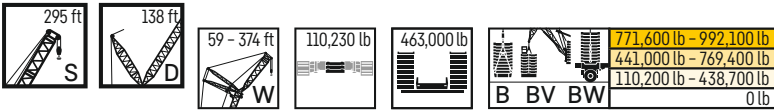

		S 295 ft															
ft	ft	W 236 ft		W 256 ft		W 276 ft		W 295 ft		W 315 ft		W 335 ft		W 354 ft		W 374 ft	
		87°/85	WVmax	87°/85	WVmax	87°/85	WVmax	87°/85	WVmax	87°/85	WVmax	87°/85	WVmax	87°/85	WVmax	87°/85	WVmax
90	B	261.0*	261.0*														
	BV																
	BW	262.0*	262.0*														
100	B	253.0*	257.0 ⁽¹⁾	229.0*	230.0 ⁽¹⁾	207.0*	207.0*										
	BV																
	BW	253.0*	260.0 ⁽¹⁾	229.0*	231.0 ⁽¹⁾	208.0*	208.0*										
110	B	256.0	256.0	222.0*	228.0 ⁽¹⁾	200.0*	204.0 ⁽¹⁾	183.0*	184.0 ⁽¹⁾	166.0*	166.0*						
	BV	258.0	258.0														
	BW	260.0	260.0	223.0*	230.0 ⁽¹⁾	201.0*	206.0 ⁽¹⁾	184.0*	185.0 ⁽¹⁾	166.0*	166.0*						
120	B	248.0	248.0	225.0	225.0	204.0	204.0	179.0*	183.0 ⁽¹⁾	162.0*	164.0 ⁽¹⁾	142.0*	143.0 ⁽¹⁾	128.0*	128.0*		
	BV	250.0	254.0 ⁽¹⁾	226.0	228.0 ⁽¹⁾	205.0	205.0										
	BW	251.0	251.0	228.0	228.0	207.0	207.0	180.0*	185.0 ⁽¹⁾	162.0*	165.0 ⁽¹⁾	142.0*	143.0 ⁽¹⁾	128.0*	128.0*		
130	B	240.0	240.0	219.0	219.0	198.0	198.0	181.0	181.0	164.0	164.0	139.0*	142.0 ⁽¹⁾	125.0*	127.0 ⁽¹⁾	110.0*	110.0 ⁽¹⁾
	BV	242.0	251.0 ⁽¹⁾	220.0	225.0 ⁽¹⁾	200.0	202.0 ⁽¹⁾	180.0	180.0	161.0	161.0						
	BW	243.0	243.0	221.0	221.0	200.0	200.0	183.0	183.0	166.0	166.0	139.0*	143.0 ⁽¹⁾	125.0*	127.0 ⁽¹⁾	110.0*	110.0 ⁽¹⁾
140	B	232.0	239.0 ⁽²⁾	212.0	213.0 ⁽²⁾	192.0	192.0	177.0	177.0	160.0	160.0	141.0	141.0	119.0	119.0	107.0*	107.0*
	BV	234.0	248.0 ⁽¹⁾	213.0	222.0 ⁽¹⁾	194.0	199.0 ⁽¹⁾	175.0	178.0 ⁽¹⁾	157.0	158.0 ⁽¹⁾	139.0	139.0	123.0	123.0		
	BW	235.0	241.0 ⁽²⁾	214.0	216.0 ⁽²⁾	195.0	195.0	179.0	179.0	162.0	162.0	143.0	143.0	128.0	128.0	107.0*	109.0 ⁽¹⁾
150	B	225.0	239.0 ⁽²⁾	204.0	212.0 ⁽²⁾	186.0	189.0 ⁽²⁾	172.0	172.0	155.0	155.0	138.0	138.0	124.0	124.0	110.0	110.0
	BV	225.0	245.0 ⁽¹⁾	206.0	219.0 ⁽¹⁾	188.0	197.0 ⁽¹⁾	170.0	175.0 ⁽¹⁾	153.0	156.0 ⁽¹⁾	136.0	137.0 ⁽¹⁾	121.0	121.0	104.0	104.0
	BW	227.0	239.0 ⁽²⁾	206.0	214.0 ⁽²⁾	189.0	191.0 ⁽²⁾	174.0	174.0	158.0	158.0	140.0	140.0	126.0	126.0	108.0	108.0
160	B	217.0	239.0 ⁽²⁾	197.0	212.0 ⁽²⁾	181.0	188.0 ⁽²⁾	168.0	171.0 ⁽²⁾	150.0	150.0	134.0	134.0	121.0	121.0	107.0	107.0
	BV	217.0	243.0 ⁽¹⁾	198.0	216.0 ⁽¹⁾	182.0	194.0 ⁽¹⁾	165.0	173.0 ⁽¹⁾	148.0	154.0 ⁽¹⁾	132.0	135.0 ⁽¹⁾	118.0	119.0 ⁽¹⁾	102.0	103.0 ⁽¹⁾
	BW	219.0	237.0 ⁽²⁾	199.0	212.0 ⁽²⁾	183.0	190.0 ⁽²⁾	170.0	172.0 ⁽²⁾	154.0	154.0	136.0	136.0	123.0	123.0	106.0	106.0
170	B	208.0	239.0 ⁽²⁾	190.0	212.0 ⁽²⁾	175.0	188.0 ⁽²⁾	162.0	170.0 ⁽²⁾	146.0	149.0 ⁽²⁾	131.0	132.0 ⁽²⁾	119.0	119.0	103.0	103.0
	BV	209.0	241.0 ⁽¹⁾	191.0	214.0 ⁽¹⁾	176.0	192.0 ⁽¹⁾	159.0	171.0 ⁽¹⁾	144.0	152.0 ⁽¹⁾	128.0	133.0 ⁽¹⁾	114.0	118.0 ⁽¹⁾	99.4	101.0 ⁽¹⁾
	BW	211.0	235.0 ⁽²⁾	192.0	210.0 ⁽²⁾	177.0	188.0 ⁽²⁾	165.0	171.0 ⁽²⁾	148.0	152.0 ⁽²⁾	133.0	133.0	120.0	120.0	103.0	103.0
180	B	199.0	236.0 ⁽²⁾	183.0	213.0 ⁽²⁾	169.0	188.0 ⁽²⁾	156.0	170.0 ⁽²⁾	141.0	149.0 ⁽²⁾	128.0	131.0 ⁽²⁾	116.0	117.0 ⁽²⁾	98.8	98.8
	BV	200.0	240.0 ⁽¹⁾	184.0	213.0 ⁽¹⁾	169.0	184.0 ⁽¹⁾	154.0	164.0 ⁽¹⁾	139.0	150.0 ⁽¹⁾	124.0	132.0 ⁽¹⁾	111.0	116.0 ⁽¹⁾	96.5	99.7 ⁽¹⁾
	BW	202.0	233.0 ⁽²⁾	186.0	208.0 ⁽²⁾	172.0	186.0 ⁽²⁾	159.0	169.0 ⁽²⁾	143.0	150.0 ⁽²⁾	129.0	132.0 ⁽²⁾	117.0	118.0 ⁽²⁾	100.0	100.0
190	B	191.0	232.0 ⁽²⁾	176.0	209.0 ⁽²⁾	163.0	188.0 ⁽²⁾	150.0	170.0 ⁽²⁾	137.0	149.0 ⁽²⁾	124.0	131.0 ⁽²⁾	112.0	116.0 ⁽²⁾	96.2	97.4 ⁽²⁾
	BV	192.0	238.0 ⁽¹⁾	177.0	211.0 ⁽¹⁾	163.0	183.0 ⁽¹⁾	149.0	163.0 ⁽¹⁾	135.0	144.0 ⁽¹⁾	120.0	130.0 ⁽¹⁾	108.0	114.0 ⁽¹⁾	93.6	98.1 ⁽¹⁾
	BW	193.0	233.0 ⁽²⁾	179.0	207.0 ⁽²⁾	166.0	185.0 ⁽²⁾	153.0	167.0 ⁽²⁾	139.0	148.0 ⁽²⁾	125.0	131.0 ⁽²⁾	114.0	117.0 ⁽²⁾	97.3	98.8 ⁽²⁾
200	B	184.0	228.0 ⁽²⁾	170.0	204.0 ⁽²⁾	157.0	186.0 ⁽²⁾	145.0	170.0 ⁽²⁾	133.0	149.0 ⁽²⁾	120.0	131.0 ⁽²⁾	108.0	116.0 ⁽²⁾	93.7	96.6 ⁽²⁾
	BV	183.0	232.0 ⁽¹⁾	169.0	210.0 ⁽¹⁾	157.0	182.0 ⁽¹⁾	144.0	161.0 ⁽¹⁾	130.0	143.0 ⁽¹⁾	117.0	125.0 ⁽¹⁾	104.0	110.0 ⁽¹⁾	90.7	96.5 ⁽¹⁾
	BW	185.0	233.0 ⁽²⁾	172.0	206.0 ⁽²⁾	158.0	184.0 ⁽²⁾	147.0	166.0 ⁽²⁾	135.0	147.0 ⁽²⁾	122.0	130.0 ⁽²⁾	111.0	116.0 ⁽²⁾	94.5	97.8 ⁽²⁾
220	B	171.0	219.0 ⁽²⁾	157.0	197.0 ⁽²⁾	144.0	181.0 ⁽²⁾	135.0	165.0 ⁽²⁾	125.0	147.0 ⁽²⁾	113.0	131.0 ⁽²⁾	99.6	116.0 ⁽²⁾	87.8	96.4 ⁽²⁾
	BV	169.0	231.0 ⁽¹⁾	155.0	205.0 ⁽¹⁾	144.0	182.0 ⁽¹⁾	133.0	160.0 ⁽¹⁾	121.0	141.0 ⁽¹⁾	109.0	122.0 ⁽¹⁾	97.4	107.0 ⁽¹⁾	84.7	91.8 ⁽¹⁾
	BW	171.0	232.0 ⁽²⁾	158.0	206.0 ⁽²⁾	145.0	183.0 ⁽²⁾	137.0	165.0 ⁽²⁾	126.0	144.0 ⁽²⁾	114.0	127.0 ⁽²⁾	103.0	114.0 ⁽²⁾	88.3	95.8 ⁽²⁾
240	B	158.0	203.0 ⁽³⁾	145.0	186.0 ⁽³⁾	134.0	175.0 ⁽³⁾	126.0	161.0 ⁽³⁾	116.0	144.0 ⁽³⁾	103.0	128.0 ⁽³⁾	93.3	114.0 ⁽³⁾	82.6	95.9 ⁽³⁾
	BV	155.0	226.0 ⁽²⁾	143.0	202.0 ⁽²⁾	132.0	181.0 ⁽²⁾	122.0	160.0 ⁽²⁾	112.0	140.0 ⁽²⁾	101.0	122.0 ⁽²⁾	90.5	106.0 ⁽²⁾	78.7	89.7 ⁽²⁾
	BW	156.0	227.0 ⁽³⁾	144.0	203.0 ⁽³⁾	134.0	182.0 ⁽³⁾	126.0	164.0 ⁽³⁾	117.0	143.0 ⁽³⁾	107.0	126.0 ⁽³⁾	94.4	112.0 ⁽³⁾	82.4	93.6 ⁽³⁾
260	B	146.0	185.0 ⁽⁵⁾	135.0	175.0 ⁽⁴⁾	125.0	166.0 ⁽⁴⁾	118.0	152.0 ⁽⁴⁾	108.0	141.0 ⁽⁴⁾	95.5	126.0 ⁽⁴⁾	87.1	112.0 ⁽⁴⁾	77.0	94.2 ⁽⁴⁾
	BV	143.0	221.0 ⁽²⁾	131.0	197.0 ⁽²⁾	122.0	177.0 ⁽²⁾	111.0	158.0 ⁽²⁾	102.0	139.0 ⁽²⁾	92.1	121.0 ⁽²⁾	83.3	105.0 ⁽²⁾	72.6	88.8 ⁽²⁾
	BW	144.0	222.0 ⁽³⁾	133.0	198.0 ⁽²⁾	125.0	178.0 ⁽²⁾	117.0	161.0 ⁽²⁾	108.0	142.0 ⁽²⁾	96.3	125.0 ⁽²⁾	88.0	110.0 ⁽²⁾	76.6	90.7 ⁽²⁾
280	B	173.0 ⁽⁷⁾	126.0	164.0 ⁽⁵⁾	117.0	156.0 ⁽⁴⁾	109.0	143.0 ⁽⁴⁾	97.4	135.0 ⁽³⁾	88.6	121.0 ⁽³⁾	81.2	110.0 ⁽²⁾	71.7	92.5 ⁽²⁾	
	BV	216.0 ⁽³⁾	122.0	193.0 ⁽²⁾	112.0	173.0 ⁽²⁾	103.0	154.0 ⁽²⁾	93.0	136.0 ⁽²⁾	83.8	119.0 ⁽²⁾	75.7	104.0 ⁽²⁾	66.1	87.8 ⁽²⁾	
	BW	217.0 ⁽³⁾	124.0	193.0 ⁽²⁾	115.0	174.0 ⁽²⁾	108.0	157.0 ⁽²⁾	96.7	139.0 ⁽²⁾	88.4	123.0 ⁽²⁾	81.2	109.0 ⁽²⁾	70.7	88.1 ⁽³⁾	
300	B	162.0 ⁽⁸⁾	152.0 ⁽⁷⁾	110.0	143.0 ⁽⁶⁾	99.1	135.0 ⁽⁵⁾	91.0	128.0 ⁽⁴⁾	82.4	116.0 ⁽³⁾	75.1	108.0 ⁽³⁾	66.4	89.6 ⁽³⁾		
	BV	212.0 ⁽³⁾	189.0 ⁽³⁾	104.0	170.0 ⁽³⁾	94.1	151.0 ⁽³⁾	86.0	133.0 ⁽³⁾	76.6	116.0 ⁽³⁾	68.5	101.0 ⁽²⁾	60.1	86.0 ⁽²⁾		
	BW	213.0 ⁽³⁾	189.0 ⁽³⁾	107.0	171.0 ⁽³⁾	97.3	154.0 ⁽³⁾	90.1	136.0 ⁽³⁾	81.6	121.0 ⁽³⁾	74.5	107.0 ⁽³⁾	65.9	88.2 ⁽³⁾		
320	B	150.0 ⁽¹¹⁾	142.0 ⁽⁹⁾		136.0 ⁽⁷⁾		128.0 ⁽⁶⁾	85.0	121.0 ⁽⁵⁾	76.5	111.0 ⁽⁴⁾	69.4	99.4 ⁽⁴⁾	61.2	87.0 ⁽⁴⁾		
	BV	203.0 ⁽⁴⁾	186.0 ⁽³⁾		167.0 ⁽³⁾	87.3	148.0 ⁽³⁾	78.6	131.0 ⁽³⁾	70.3	114.0 ⁽³⁾	62.8	99.8 ⁽³⁾	54.7	84.4 ⁽³⁾		
	BW	202.0 ⁽³⁾	186.0 ⁽³⁾		168.0 ⁽³⁾	90.7	151.0 ⁽³⁾	83.2	134.0 ⁽³⁾	75.8	119.0 ⁽³⁾	68.7	105.0 ⁽³⁾	60.5	87.7 ⁽³⁾		
340	B	130.0 ⁽¹¹⁾	133.0 ⁽¹¹⁾		128.0 ⁽⁹⁾		120.0 ⁽⁷⁾	79.8	114.0 ⁽⁶⁾	71.6	105.0 ⁽⁵⁾	64.4	93.1 ⁽⁵⁾	56.5	85.0 ⁽⁴⁾		
	BV	190.0 ⁽⁵⁾	182.0 ⁽⁴⁾		164.0 ⁽⁵⁾		146.0 ⁽⁵⁾	72.8	129.0 ⁽⁵⁾	64.2	112.0 ⁽⁵⁾	57.7	98.0 ⁽⁵⁾	50.4	82.4 ⁽⁵⁾		
	BW	190.0 ⁽⁵⁾	180.0 ⁽⁴⁾		165.0 ⁽⁵⁾		148.0 ⁽⁵⁾	77.6	132.0 ⁽⁵⁾	69.8	117.0 ⁽⁵⁾	63.3	102.0 ⁽⁵⁾	55.9	85.7 ⁽⁴⁾		
360	B	110.0 ⁽¹¹⁾	114.0 ⁽¹¹⁾		120.0 ⁽¹¹⁾		114.0 ⁽⁹⁾		105.0 ⁽⁷⁾	66.9	94.0 ⁽⁶⁾	59.6	87.8 ⁽⁶⁾	50.4	80.8 ⁽⁵⁾		
	BV	175.0 ⁽⁸⁾	168.0 ⁽⁵⁾		159.0 ⁽⁵⁾		143.0 ⁽⁴⁾		126.0 ⁽⁴⁾	59.7	110.0 ⁽³⁾	52.9	96.1 ⁽³⁾	45.8	80.3 ⁽⁵⁾		
	BW	176.0 ⁽⁸⁾	168.0 ⁽⁵⁾		160.0 ⁽⁵⁾		145.0 ⁽⁴⁾		130.0 ⁽³⁾	64.9	115.0 ⁽³⁾	58.1	100.0 ⁽³⁾	49.5	84.2 ⁽⁵⁾		
380	B	87.2 ⁽⁹⁾	94.0 ⁽¹¹⁾		101.0 ⁽¹¹⁾		106.0 ⁽¹¹⁾		97.6 ⁽⁹⁾		90.0 ⁽⁸⁾	55.9	83.2 ⁽⁷⁾	45.9	76.2 ⁽⁶⁾		
	BV	157.0 ⁽⁹⁾	157.0 ⁽⁸⁾		152.0 ⁽⁶⁾												

SDWB/SDWBV/SDWBW

S 315

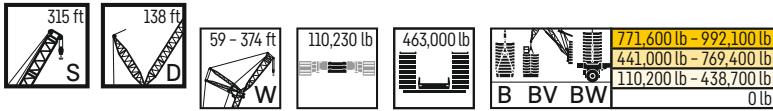

ft	S 315 ft																	
	W 59 ft		W 79 ft		W 98 ft		W 118 ft		W 138 ft		W 158 ft		W 177 ft		W 197 ft		W 217 ft	
	87°/85	WVmax	87°/85	WVmax	87°/85	WVmax	87°/85	WVmax	87°/85	WVmax	87°/85	WVmax	87°/85	WVmax	87°/85	WVmax	87°/85	WVmax
50	B	617.0*	621.0 ⁽¹⁾															
	BV	620.0*	629.0 ⁽¹⁾															
	BW	621.0	621.0	529.0*	533.0 ⁽¹⁾	496.0*	499.0 ⁽¹⁾											
60	B	626.0	626.0															
	BV	628.0	628.0	533.0*	543.0 ⁽¹⁾	497.0*	501.0 ⁽¹⁾											
	BW	590.0	616.0 ⁽¹⁾	539.0	539.0	474.0*	497.0 ⁽¹⁾	433.0*	443.0 ⁽¹⁾	396.0*	398.0 ⁽¹⁾	363.0*	363.0*					
70	B	591.0	614.0 ⁽¹⁾	539.0	546.0 ⁽¹⁾	503.0	503.0											
	BV	593.0	605.0 ⁽²⁾	540.0	540.0	476.0*	501.0 ⁽¹⁾	436.0*	447.0 ⁽¹⁾	398.0*	400.0 ⁽¹⁾	365.0*	365.0*					
	BW	555.0	613.0 ⁽¹⁾	508.0	530.0 ⁽²⁾	477.0	491.0 ⁽²⁾	436.0	439.0 ⁽¹⁾	378.0*	393.0 ⁽¹⁾	347.0*	354.0 ⁽¹⁾	317.0*	318.0 ⁽¹⁾	291.0*	291.0*	
80	B	556.0	602.0 ⁽¹⁾	508.0	536.0 ⁽¹⁾	480.0	492.0 ⁽¹⁾	439.0	442.0 ⁽¹⁾									
	BV	557.0	594.0 ⁽²⁾	509.0	526.0 ⁽²⁾	482.0	494.0 ⁽¹⁾	441.0	444.0 ⁽¹⁾	380.0*	396.0 ⁽¹⁾	350.0*	358.0 ⁽¹⁾	319.0*	321.0 ⁽¹⁾	293.0*	293.0*	
	BW	526.0	610.0 ⁽¹⁾	479.0	527.0 ⁽²⁾	453.0	489.0 ⁽¹⁾	415.0	436.0 ⁽¹⁾	382.0	390.0 ⁽¹⁾	350.0	350.0	303.0*	314.0 ⁽¹⁾	280.0*	285.0 ⁽¹⁾	255.0*
90	B	526.0	591.0 ⁽¹⁾	475.0	525.0 ⁽¹⁾	456.0	483.0 ⁽¹⁾	419.0	434.0 ⁽¹⁾	384.0	391.0 ⁽¹⁾	352.0	353.0 ⁽¹⁾					
	BV	529.0	583.0 ⁽²⁾	477.0	516.0 ⁽²⁾	458.0	485.0 ⁽¹⁾	421.0	436.0 ⁽¹⁾	384.0	391.0 ⁽¹⁾	353.0	354.0 ⁽¹⁾	305.0*	318.0 ⁽¹⁾	283.0*	288.0 ⁽¹⁾	256.0*
	BW	590.0 ⁽²⁾	452.0	525.0 ⁽²⁾	429.0	486.0 ⁽¹⁾	396.0	433.0 ⁽¹⁾	365.0	388.0 ⁽¹⁾	336.0	348.0 ⁽¹⁾	307.0	308.0 ⁽¹⁾	283.0	283.0	245.0*	257.0 ⁽¹⁾
100	B	588.0 ⁽¹⁾	450.0	514.0 ⁽¹⁾	432.0	475.0 ⁽¹⁾	399.0	427.0 ⁽¹⁾	367.0	384.0 ⁽¹⁾	338.0	347.0 ⁽¹⁾	309.0	312.0 ⁽¹⁾	284.0	284.0	247.0*	255.0 ⁽¹⁾
	BV	576.0 ⁽²⁾	451.0	506.0 ⁽²⁾	434.0	477.0 ⁽¹⁾	400.0	429.0 ⁽¹⁾	368.0	384.0 ⁽¹⁾	340.0	348.0 ⁽¹⁾	311.0	311.0	286.0	286.0	247.0*	255.0 ⁽¹⁾
	BW	563.0 ⁽²⁾	430.0	515.0 ⁽²⁾	408.0	478.0 ⁽¹⁾	375.0	431.0 ⁽¹⁾	349.0	386.0 ⁽¹⁾	322.0	344.0 ⁽¹⁾	295.0	307.0 ⁽¹⁾	274.0	274.0	248.0	248.0
110	B	587.0 ⁽¹⁾	425.0	513.0 ⁽¹⁾	409.0	468.0 ⁽¹⁾	379.0	419.0 ⁽¹⁾	350.0	377.0 ⁽¹⁾	324.0	341.0 ⁽¹⁾	297.0	307.0 ⁽¹⁾	275.0	280.0 ⁽¹⁾	250.0	251.0 ⁽¹⁾
	BV	576.0 ⁽²⁾	427.0	499.0 ⁽²⁾	411.0	469.0 ⁽¹⁾	380.0	421.0 ⁽¹⁾	350.0	378.0 ⁽¹⁾	326.0	343.0 ⁽¹⁾	297.0	302.0 ⁽¹⁾	276.0	276.0	250.0	250.0
	BW	536.0 ⁽¹⁾		494.0 ⁽²⁾	388.0	461.0 ⁽¹⁾	357.0	421.0 ⁽¹⁾	332.0	383.0 ⁽¹⁾	308.0	344.0 ⁽¹⁾	283.0	305.0 ⁽¹⁾	263.0	267.0 ⁽²⁾	240.0	240.0
120	B	587.0 ⁽¹⁾		512.0 ⁽¹⁾	390.0	466.0 ⁽¹⁾	359.0	414.0 ⁽¹⁾	333.0	371.0 ⁽¹⁾	309.0	335.0 ⁽¹⁾	285.0	302.0 ⁽¹⁾	264.0	275.0 ⁽¹⁾	241.0	247.0 ⁽¹⁾
	BV	576.0 ⁽²⁾		498.0 ⁽²⁾	392.0	467.0 ⁽¹⁾	362.0	416.0 ⁽¹⁾	334.0	372.0 ⁽¹⁾	311.0	337.0 ⁽¹⁾	286.0	294.0 ⁽²⁾	266.0	268.0 ⁽²⁾	242.0	242.0
	BW	511.0 ⁽¹⁾		473.0 ⁽²⁾	373.0	445.0 ⁽¹⁾	340.0	407.0 ⁽¹⁾	318.0	373.0 ⁽¹⁾	294.0	341.0 ⁽¹⁾	272.0	304.0 ⁽¹⁾	253.0	266.0 ⁽²⁾	232.0	232.0
130	B	574.0 ⁽¹⁾		511.0 ⁽¹⁾	371.0	464.0 ⁽¹⁾	344.0	412.0 ⁽¹⁾	318.0	368.0 ⁽¹⁾	295.0	330.0 ⁽¹⁾	272.0	297.0 ⁽¹⁾	254.0	271.0 ⁽¹⁾	232.0	243.0 ⁽¹⁾
	BV	563.0 ⁽¹⁾		498.0 ⁽²⁾	374.0	465.0 ⁽¹⁾	344.0	414.0 ⁽¹⁾	318.0	362.0 ⁽¹⁾	296.0	331.0 ⁽¹⁾	274.0	290.0 ⁽¹⁾	256.0	265.0 ⁽²⁾	234.0	237.0 ⁽²⁾
	BW	482.0 ⁽¹⁾		451.0 ⁽²⁾		428.0 ⁽¹⁾	326.0	394.0 ⁽¹⁾	303.0	363.0 ⁽¹⁾	281.0	331.0 ⁽¹⁾	260.0	299.0 ⁽¹⁾	242.0	266.0 ⁽²⁾	223.0	230.0 ⁽¹⁾
140	B	553.0 ⁽¹⁾		498.0 ⁽¹⁾		462.0 ⁽¹⁾	327.0	410.0 ⁽¹⁾	303.0	366.0 ⁽¹⁾	282.0	328.0 ⁽¹⁾	260.0	293.0 ⁽¹⁾	244.0	266.0 ⁽¹⁾	223.0	239.0 ⁽¹⁾
	BV	535.0 ⁽⁶⁾		496.0 ⁽²⁾		462.0 ⁽¹⁾	329.0	411.0 ⁽¹⁾	302.0	354.0 ⁽²⁾	283.0	319.0 ⁽²⁾	262.0	286.0 ⁽²⁾	245.0	261.0 ⁽²⁾	225.0	234.0 ⁽²⁾
	BW	453.0 ⁽¹⁾		429.0 ⁽⁵⁾		408.0 ⁽²⁾	315.0	381.0 ⁽¹⁾	289.0	353.0 ⁽¹⁾	270.0	323.0 ⁽²⁾	248.0	294.0 ⁽²⁾	233.0	266.0 ⁽²⁾	215.0	236.0 ⁽²⁾
150	B	531.0 ⁽¹⁾		483.0 ⁽²⁾		452.0 ⁽¹⁾	312.0	408.0 ⁽¹⁾	290.0	364.0 ⁽¹⁾	269.0	326.0 ⁽¹⁾	249.0	291.0 ⁽¹⁾	233.0	263.0 ⁽¹⁾	215.0	235.0 ⁽¹⁾
	BV	522.0 ⁽¹⁰⁾		482.0 ⁽²⁾		451.0 ⁽¹⁾	315.0	409.0 ⁽¹⁾	289.0	353.0 ⁽²⁾	271.0	317.0 ⁽²⁾	250.0	282.0 ⁽²⁾	235.0	257.0 ⁽²⁾	217.0	231.0 ⁽²⁾
	BW			408.0 ⁽⁷⁾		385.0 ⁽¹⁾		365.0 ⁽²⁾	278.0	343.0 ⁽¹⁾	258.0	313.0 ⁽²⁾	238.0	287.0 ⁽²⁾	224.0	265.0 ⁽²⁾	205.0	236.0 ⁽²⁾
160	B			469.0 ⁽²⁾		440.0 ⁽¹⁾		401.0 ⁽¹⁾	277.0	362.0 ⁽¹⁾	258.0	324.0 ⁽¹⁾	238.0	289.0 ⁽¹⁾	223.0	261.0 ⁽¹⁾	206.0	233.0 ⁽¹⁾
	BV			468.0 ⁽²⁾		440.0 ⁽¹⁾		401.0 ⁽¹⁾	277.0	353.0 ⁽²⁾	259.0	317.0 ⁽²⁾	239.0	280.0 ⁽²⁾	225.0	253.0 ⁽²⁾	208.0	228.0 ⁽²⁾
	BW			384.0 ⁽¹¹⁾		369.0 ⁽¹⁾		347.0 ⁽⁴⁾	270.0	331.0 ⁽²⁾	247.0	304.0 ⁽²⁾	229.0	281.0 ⁽²⁾	216.0	260.0 ⁽²⁾	197.0	235.0 ⁽²⁾
170	B			454.0 ⁽²⁾		428.0 ⁽¹⁾		393.0 ⁽¹⁾	265.0	353.0 ⁽²⁾	246.0	321.0 ⁽¹⁾	227.0	287.0 ⁽¹⁾	214.0	260.0 ⁽¹⁾	197.0	231.0 ⁽¹⁾
	BV			454.0 ⁽²⁾		428.0 ⁽¹⁾		393.0 ⁽¹⁾	266.0	352.0 ⁽²⁾	248.0	316.0 ⁽²⁾	229.0	280.0 ⁽²⁾	216.0	252.0 ⁽²⁾	199.0	225.0 ⁽²⁾
	BW			358.0 ⁽¹⁰⁾		352.0 ⁽¹⁾		334.0 ⁽¹⁾	237.0	317.0 ⁽³⁾	237.0	315.0 ⁽²⁾	219.0	274.0 ⁽²⁾	206.0	254.0 ⁽²⁾	190.0	231.0 ⁽²⁾
180	B			440.0 ⁽²⁾		416.0 ⁽¹⁾		385.0 ⁽¹⁾	235.0	348.0 ⁽²⁾	235.0	314.0 ⁽²⁾	218.0	282.0 ⁽¹⁾	205.0	258.0 ⁽¹⁾	189.0	230.0 ⁽¹⁾
	BV			440.0 ⁽²⁾		416.0 ⁽¹⁾		385.0 ⁽¹⁾	237.0	346.0 ⁽²⁾	237.0	315.0 ⁽²⁾	220.0	279.0 ⁽²⁾	206.0	251.0 ⁽²⁾	190.0	224.0 ⁽²⁾
	BW			334.0 ⁽¹⁰⁾		333.0 ⁽¹⁰⁾		319.0 ⁽⁷⁾	232.0	299.0 ⁽⁴⁾	232.0	284.0 ⁽³⁾	211.0	268.0 ⁽²⁾	198.0	249.0 ⁽²⁾	183.0	227.0 ⁽²⁾
190	B			426.0 ⁽²⁾		404.0 ⁽¹⁾		378.0 ⁽¹⁾	227.0	343.0 ⁽²⁾	227.0	311.0 ⁽²⁾	209.0	278.0 ⁽²⁾	197.0	252.0 ⁽¹⁾	182.0	228.0 ⁽¹⁾
	BV			427.0 ⁽²⁾		405.0 ⁽¹⁾		378.0 ⁽¹⁾	229.0	340.0 ⁽²⁾	229.0	311.0 ⁽²⁾	210.0	279.0 ⁽²⁾	198.0	250.0 ⁽²⁾	183.0	224.0 ⁽²⁾
	BW			309.0 ⁽¹⁰⁾		311.0 ⁽¹⁰⁾		304.0 ⁽⁸⁾	288.0 ⁽¹⁾	288.0 ⁽¹⁾	273.0 ⁽⁴⁾	203.0	257.0 ⁽³⁾	191.0	244.0 ⁽²⁾	176.0	224.0 ⁽²⁾	
200	B			411.0 ⁽²⁾		392.0 ⁽¹⁾		370.0 ⁽¹⁾	270.0	337.0 ⁽²⁾	246.0	308.0 ⁽²⁾	200.0	276.0 ⁽²⁾	189.0	250.0 ⁽²⁾	175.0	221.0 ⁽²⁾
	BV			413.0 ⁽²⁾		393.0 ⁽¹⁾		370.0 ⁽¹⁾	270.0	335.0 ⁽²⁾	248.0	307.0 ⁽²⁾	201.0	276.0 ⁽²⁾	190.0	250.0 ⁽²⁾	176.0	223.0 ⁽²⁾
	BW			260.0 ⁽¹⁰⁾		267.0 ⁽¹⁰⁾		267.0 ⁽⁹⁾	264.0 ⁽¹⁾	264.0 ⁽¹⁾	251.0 ⁽⁷⁾	200.0	238.0 ⁽⁵⁾	178.0	227.0 ⁽³⁾	165.0	212.0 ⁽³⁾	
220	B			371.0 ⁽⁷⁾		360.0 ⁽³⁾		354.0 ⁽¹⁾	237.0	326.0 ⁽²⁾	237.0	301.0 ⁽²⁾	200.0	246.0 ⁽²⁾	173.0	246.0 ⁽²⁾	160.0	219.0 ⁽²⁾
	BV			372.0 ⁽⁸⁾		360.0 ⁽³⁾		355.0 ⁽¹⁾	237.0	324.0 ⁽²⁾	237.0	299.0 ⁽²⁾	200.0	246.0 ⁽²⁾	173.0	246.0 ⁽²⁾	163.0	220.0 ⁽²⁾
	BW			222.0 ⁽¹⁰⁾		222.0 ⁽¹⁰⁾		230.0 ⁽⁹⁾	234.0 ⁽¹⁰⁾	234.0 ⁽¹⁰⁾	235.0 ⁽¹¹⁾	200.0	222.0 ⁽⁷⁾	176.0	213.0 ⁽⁵⁾	152.0	196.0 ⁽⁵⁾	
240	B					324.0 ⁽⁸⁾		320.0 ⁽⁴⁾	230.0	315.0 ⁽²⁾	230.0	295.0 ⁽²⁾	200.0	266.0 ⁽²⁾	180.0	242.0 ⁽²⁾	148.0	216.0 ⁽²⁾
	BV					325.0 ⁽⁸⁾		321.0 ⁽⁴⁾	230.0	313.0 ⁽²⁾	230.0	290.0 ⁽²⁾	200.0	265.0 ⁽²⁾	180.0	242.0 ⁽²⁾	149.0	216.0 ⁽²⁾
	BW					188.0 ⁽⁸⁾		194.0 ⁽¹⁰⁾	203.0 ⁽¹⁰⁾	203.0 ⁽¹⁰⁾	208.0 ⁽¹⁰⁾	200.0	205.0 ⁽¹¹⁾	178.0	192.0 ⁽¹¹⁾	152.0	180.0 ⁽⁶⁾	
260	B					285.0 ⁽⁸⁾		291.0 ⁽⁹⁾	286.0 ⁽⁴⁾	286.0 ⁽⁴⁾	280.0 ⁽²⁾	200.0	262.0 ⁽²⁾	180.0	238.0 ⁽²⁾	150.0	212.0 ⁽²⁾	
	BV					286.0 ⁽⁸⁾		292.0 ⁽⁹⁾	285.0 ⁽⁴⁾	285.0 ⁽⁴⁾	279.0 ⁽³⁾	200.0	259.0 ⁽²⁾	180.0	238.0 ⁽²⁾	150.0	212.0 ⁽²⁾	
	BW					155.0 ⁽⁸⁾		163.0 ⁽⁸⁾	172.0 ⁽¹⁰⁾	172.0 ⁽¹⁰⁾	180.0 ⁽¹⁰⁾	200.0	184.0 ⁽¹¹⁾	179.0 ⁽¹¹⁾	152.0	179.0 ⁽¹¹⁾	169.0 ⁽⁸⁾	
280	B					245.0 ⁽⁸⁾		255.0 ⁽⁸⁾										

SDWB/SDWBV/SDWBW

S 315

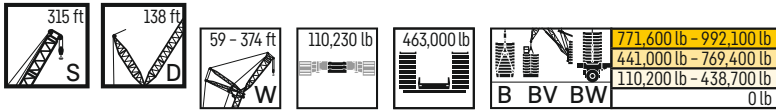

		S 315 ft																
ft	ft	W 236 ft		W 256 ft		W 276 ft		W 295 ft		W 315 ft		W 335 ft		W 354 ft		W 374 ft		
		87°/85	WVmax	87°/85	WVmax	87°/85	WVmax	87°/85	WVmax	87°/85	WVmax	87°/85	WVmax	87°/85	WVmax	87°/85	WVmax	
90	B	232.0*	232.0*															
	BV	232.0*	232.0*															
	BW	224.0*	227.0 ⁽¹⁾	202.0*	202.0*	185.0*	185.0*											
100	B	225.0*	229.0 ⁽¹⁾	202.0*	202.0*	186.0*	186.0*											
	BV	226.0	226.0	196.0*	201.0 ⁽¹⁾	180.0*	182.0 ⁽¹⁾	163.0*	163.0*	145.0*	145.0*							
	BW	222.0	222.0	196.0*	201.0 ⁽¹⁾	181.0*	183.0 ⁽¹⁾	163.0*	164.0 ⁽¹⁾	145.0*	145.0*							
110	B	219.0	219.0	199.0	199.0	181.0	181.0	157.0*	161.0 ⁽¹⁾	141.0*	142.0 ⁽¹⁾	126.0*	126.0*	113.0*	113.0*			
	BV	219.0	222.0 ⁽¹⁾	198.0	198.0	179.0	179.0											
	BW	222.0	222.0	199.0	199.0	183.0	183.0	158.0*	163.0 ⁽¹⁾	141.0*	143.0 ⁽¹⁾	126.0*	126.0*	113.0*	113.0*			
120	B	212.0	212.0	193.0	193.0	177.0	177.0	160.0	160.0	140.0	140.0	123.0*	125.0 ⁽¹⁾	110.0*	111.0 ⁽¹⁾	93.3*	93.4 ⁽¹⁾	
	BV	212.0	219.0 ⁽¹⁾	192.0	195.0 ⁽¹⁾	174.0	175.0 ⁽¹⁾	156.0	156.0	139.0	139.0							
	BW	214.0	214.0	193.0	193.0	178.0	178.0	161.0	161.0	137.0*	142.0 ⁽¹⁾	123.0*	125.0 ⁽¹⁾	110.0*	111.0 ⁽¹⁾	92.6*	92.8 ⁽¹⁾	
140	B	203.0	211.0 ⁽²⁾	187.0	188.0 ⁽²⁾	172.0	172.0	155.0	155.0	138.0	138.0	123.0	123.0	105.0*	105.0*	88.1	88.1	
	BV	205.0	215.0 ⁽¹⁾	185.0	192.0 ⁽¹⁾	169.0	173.0 ⁽¹⁾	152.0	154.0 ⁽¹⁾	136.0	136.0	119.0	119.0	105.0	105.0			
	BW	206.0	210.0 ⁽²⁾	187.0	187.0	173.0	173.0	156.0	156.0	139.0	139.0	125.0	125.0	106.0*	110.0 ⁽¹⁾	89.5*	91.6 ⁽¹⁾	
150	B	196.0	211.0 ⁽²⁾	181.0	188.0 ⁽²⁾	167.0	168.0 ⁽²⁾	149.0	149.0	135.0	135.0	121.0	121.0	108.0	108.0	91.6	91.6	
	BV	197.0	212.0 ⁽¹⁾	179.0	189.0 ⁽¹⁾	163.0	170.0 ⁽¹⁾	147.0	151.0 ⁽¹⁾	132.0	134.0 ⁽¹⁾	116.0	117.0 ⁽¹⁾	103.0	103.0	88.1	88.1	
	BW	198.0	207.0 ⁽²⁾	180.0	185.0 ⁽²⁾	168.0	169.0 ⁽²⁾	151.0	151.0	136.0	136.0	122.0	122.0	109.0	109.0	90.7	90.7	
160	B	189.0	211.0 ⁽²⁾	176.0	188.0 ⁽²⁾	161.0	168.0 ⁽²⁾	144.0	147.0 ⁽²⁾	131.0	131.0	117.0	117.0	105.0	105.0	89.5	89.5	
	BV	189.0	208.0 ⁽¹⁾	172.0	186.0 ⁽¹⁾	157.0	167.0 ⁽¹⁾	142.0	149.0 ⁽¹⁾	128.0	132.0 ⁽¹⁾	113.0	115.0 ⁽¹⁾	99.8	101.0 ⁽¹⁾	85.6	86.2 ⁽¹⁾	
	BW	190.0	204.0 ⁽²⁾	174.0	182.0 ⁽²⁾	162.0	167.0 ⁽²⁾	146.0	147.0 ⁽²⁾	132.0	132.0	118.0	118.0	106.0	106.0	88.1	88.1	
170	B	182.0	210.0 ⁽²⁾	169.0	187.0 ⁽²⁾	154.0	168.0 ⁽²⁾	140.0	147.0 ⁽²⁾	127.0	130.0 ⁽²⁾	114.0	115.0 ⁽²⁾	99.9	99.9	87.2	87.2	
	BV	182.0	207.0 ⁽¹⁾	166.0	184.0 ⁽¹⁾	152.0	164.0 ⁽¹⁾	137.0	146.0 ⁽¹⁾	123.0	130.0 ⁽¹⁾	109.0	113.0 ⁽¹⁾	96.7	99.3 ⁽¹⁾	83.0	84.5 ⁽¹⁾	
	BW	183.0	201.0 ⁽²⁾	168.0	180.0 ⁽²⁾	155.0	164.0 ⁽²⁾	141.0	145.0 ⁽²⁾	128.0	130.0 ⁽²⁾	115.0	115.0	101.0	101.0	85.6	85.6	
180	B	176.0	209.0 ⁽²⁾	163.0	187.0 ⁽²⁾	149.0	168.0 ⁽²⁾	136.0	146.0 ⁽²⁾	123.0	130.0 ⁽²⁾	111.0	114.0 ⁽²⁾	96.5	97.5 ⁽²⁾	84.6	84.6	
	BV	175.0	205.0 ⁽¹⁾	160.0	182.0 ⁽¹⁾	146.0	162.0 ⁽¹⁾	132.0	144.0 ⁽¹⁾	119.0	127.0 ⁽¹⁾	106.0	111.0 ⁽¹⁾	93.6	97.4 ⁽¹⁾	80.4	82.8 ⁽¹⁾	
	BW	176.0	199.0 ⁽²⁾	162.0	178.0 ⁽²⁾	149.0	162.0 ⁽²⁾	136.0	144.0 ⁽²⁾	124.0	129.0 ⁽²⁾	112.0	114.0 ⁽²⁾	97.2	97.2 ⁽²⁾	83.1	83.1	
190	B	169.0	204.0 ⁽²⁾	156.0	186.0 ⁽²⁾	143.0	167.0 ⁽²⁾	131.0	146.0 ⁽²⁾	119.0	130.0 ⁽²⁾	107.0	114.0 ⁽²⁾	93.9	97.3 ⁽²⁾	82.3	83.7 ⁽²⁾	
	BV	168.0	203.0 ⁽¹⁾	153.0	180.0 ⁽¹⁾	141.0	161.0 ⁽¹⁾	127.0	142.0 ⁽¹⁾	115.0	122.0 ⁽¹⁾	102.0	109.0 ⁽¹⁾	90.4	95.6 ⁽¹⁾	77.6	81.2 ⁽¹⁾	
	BW	170.0	198.0 ⁽²⁾	155.0	176.0 ⁽²⁾	144.0	160.0 ⁽²⁾	132.0	142.0 ⁽²⁾	120.0	127.0 ⁽²⁾	107.0	112.0 ⁽²⁾	94.4	96.6 ⁽²⁾	80.5	81.6 ⁽²⁾	
200	B	163.0	201.0 ⁽²⁾	150.0	183.0 ⁽²⁾	138.0	166.0 ⁽²⁾	127.0	146.0 ⁽²⁾	115.0	130.0 ⁽²⁾	101.0	114.0 ⁽²⁾	91.1	97.0 ⁽²⁾	79.9	83.4 ⁽²⁾	
	BV	161.0	201.0 ⁽¹⁾	147.0	178.0 ⁽¹⁾	135.0	159.0 ⁽¹⁾	123.0	140.0 ⁽¹⁾	111.0	120.0 ⁽¹⁾	98.2	105.0 ⁽¹⁾	87.1	93.7 ⁽¹⁾	74.7	79.5 ⁽¹⁾	
	BW	163.0	197.0 ⁽²⁾	148.0	175.0 ⁽²⁾	139.0	158.0 ⁽²⁾	127.0	140.0 ⁽²⁾	116.0	125.0 ⁽²⁾	102.0	111.0 ⁽²⁾	91.5	95.3 ⁽²⁾	77.7	80.7 ⁽²⁾	
220	B	149.0	193.0 ⁽²⁾	139.0	178.0 ⁽²⁾	129.0	162.0 ⁽²⁾	118.0	144.0 ⁽²⁾	107.0	129.0 ⁽²⁾	94.1	113.0 ⁽²⁾	85.1	96.6 ⁽²⁾	74.5	82.9 ⁽²⁾	
	BV	149.0	195.0 ⁽¹⁾	136.0	172.0 ⁽¹⁾	125.0	156.0 ⁽¹⁾	113.0	137.0 ⁽¹⁾	102.0	117.0 ⁽¹⁾	90.9	102.0 ⁽¹⁾	80.6	88.5 ⁽¹⁾	69.1	74.6 ⁽¹⁾	
	BW	150.0	186.0 ⁽²⁾	137.0	174.0 ⁽²⁾	128.0	157.0 ⁽²⁾	119.0	138.0 ⁽²⁾	108.0	123.0 ⁽²⁾	94.6	108.0 ⁽²⁾	85.5	92.8 ⁽²⁾	71.6	78.9 ⁽²⁾	
240	B	139.0	183.0 ⁽³⁾	130.0	169.0 ⁽³⁾	119.0	158.0 ⁽³⁾	109.0	142.0 ⁽³⁾	97.4	127.0 ⁽³⁾	87.7	112.0 ⁽³⁾	79.4	95.8 ⁽³⁾	69.6	82.4 ⁽³⁾	
	BV	136.0	193.0 ⁽²⁾	125.0	171.0 ⁽²⁾	115.0	151.0 ⁽²⁾	104.0	133.0 ⁽²⁾	94.4	116.0 ⁽²⁾	83.7	100.0 ⁽²⁾	74.2	86.3 ⁽²⁾	63.7	71.9 ⁽²⁾	
	BW	137.0	193.0 ⁽¹⁾	127.0	172.0 ⁽¹⁾	120.0	155.0 ⁽¹⁾	110.0	136.0 ⁽¹⁾	97.6	121.0 ⁽¹⁾	88.2	105.0 ⁽¹⁾	79.8	90.7 ⁽¹⁾	66.1	77.1 ⁽¹⁾	
260	B	131.0	170.0 ⁽⁴⁾	122.0	159.0 ⁽⁴⁾	113.0	149.0 ⁽⁴⁾	99.1	136.0 ⁽⁴⁾	90.4	125.0 ⁽⁴⁾	81.7	110.0 ⁽⁴⁾	73.8	84.5 ⁽⁴⁾	64.7	81.1 ⁽⁴⁾	
	BV	126.0	190.0 ⁽³⁾	114.0	168.0 ⁽³⁾	106.0	149.0 ⁽³⁾	95.3	131.0 ⁽³⁾	86.5	115.0 ⁽³⁾	76.8	98.8 ⁽³⁾	68.0	85.1 ⁽³⁾	58.8	70.7 ⁽³⁾	
	BW	127.0	190.0 ⁽²⁾	117.0	170.0 ⁽²⁾	111.0	153.0 ⁽²⁾	98.9	135.0 ⁽²⁾	90.5	120.0 ⁽²⁾	82.1	104.0 ⁽²⁾	74.1	89.3 ⁽²⁾	60.4	73.6 ⁽²⁾	
280	B	161.0 ⁽⁶⁾	114.0	149.0 ⁽⁶⁾	102.0	141.0 ⁽⁶⁾	92.8	130.0 ⁽⁶⁾	84.1	120.0 ⁽⁶⁾	75.6	106.0 ⁽⁶⁾	67.9	93.3 ⁽⁶⁾	59.4	79.9 ⁽⁶⁾		
	BV	187.0 ⁽²⁾	106.0	165.0 ⁽²⁾	96.7	147.0 ⁽²⁾	87.7	129.0 ⁽²⁾	78.6	113.0 ⁽²⁾	69.9	97.4 ⁽²⁾	62.3	83.9 ⁽²⁾	54.1	69.5 ⁽²⁾		
	BW	187.0 ⁽¹⁾	109.0	167.0 ⁽¹⁾	99.7	150.0 ⁽¹⁾	91.4	133.0 ⁽¹⁾	83.4	118.0 ⁽¹⁾	75.7	102.0 ⁽¹⁾	68.5	87.8 ⁽¹⁾	55.1	71.6 ⁽¹⁾		
300	B	148.0 ⁽⁸⁾	139.0 ⁽⁸⁾	95.8	133.0 ⁽⁸⁾	86.2	123.0 ⁽⁸⁾	78.9	114.0 ⁽⁸⁾	70.1	104.0 ⁽⁸⁾	62.8	89.4 ⁽⁸⁾	53.1	77.0 ⁽⁸⁾			
	BV	184.0 ⁽²⁾	163.0 ⁽²⁾	89.3	145.0 ⁽²⁾	80.0	127.0 ⁽²⁾	72.2	111.0 ⁽²⁾	63.4	95.7 ⁽²⁾	56.9	82.4 ⁽²⁾	49.4	68.3 ⁽²⁾			
	BW	184.0 ⁽¹⁾	165.0 ⁽¹⁾	92.5	147.0 ⁽¹⁾	84.1	131.0 ⁽¹⁾	77.5	115.0 ⁽¹⁾	69.3	97.8 ⁽¹⁾	62.8	84.6 ⁽¹⁾	50.3	70.8 ⁽¹⁾			
320	B	140.0 ⁽¹¹⁾	131.0 ⁽⁸⁾	123.0 ⁽⁷⁾	95.2 ⁽¹¹⁾	81.5	115.0 ⁽⁷⁾	73.3	108.0 ⁽⁸⁾	66.0	97.3 ⁽⁸⁾	58.3	85.4 ⁽⁸⁾	47.4	76.4 ⁽⁸⁾			
	BV	181.0 ⁽³⁾	160.0 ⁽²⁾	142.0 ⁽²⁾	97.7	142.0 ⁽²⁾	73.7	125.0 ⁽²⁾	65.6	109.0 ⁽²⁾	58.5	94.2 ⁽²⁾	52.0	80.8 ⁽²⁾	44.4	66.9 ⁽²⁾		
	BW	181.0 ⁽³⁾	162.0 ⁽²⁾	145.0 ⁽²⁾	99.7	145.0 ⁽²⁾	78.3	129.0 ⁽²⁾	71.1	113.0 ⁽³⁾	64.1	95.9 ⁽³⁾	57.5	83.7 ⁽³⁾	45.7	69.9 ⁽³⁾		
340	B	123.0 ⁽¹¹⁾	124.0 ⁽¹¹⁾	117.0 ⁽⁸⁾	110.0 ⁽¹¹⁾	109.0 ⁽⁷⁾	99.3	109.0 ⁽⁷⁾	69.3	98.8 ⁽⁶⁾	60.9	92.1 ⁽⁶⁾	53.2	82.1 ⁽⁶⁾	44.3	72.5 ⁽⁶⁾		
	BV	175.0 ⁽⁵⁾	156.0 ⁽⁴⁾	140.0 ⁽³⁾	127.0 ⁽⁵⁾	123.0 ⁽³⁾	108.0	123.0 ⁽³⁾	60.8	108.0 ⁽³⁾	53.5	92.2 ⁽³⁾	47.5	79.3 ⁽³⁾	40.3	65.6 ⁽³⁾		
	BW	175.0 ⁽⁵⁾	158.0 ⁽⁴⁾	143.0 ⁽³⁾	127.0 ⁽⁵⁾	123.0 ⁽³⁾	110.0	123.0 ⁽³⁾	65.9	113.0 ⁽³⁾	58.7	95.1 ⁽³⁾	51.6	82.2 ⁽³⁾	41.8	67.8 ⁽³⁾		
360	B	104.0 ⁽¹¹⁾	108.0 ⁽¹¹⁾	111.0 ⁽¹¹⁾	100.0 ⁽⁸⁾	100.0 ⁽⁸⁾	93.8 ⁽⁷⁾	93.8 ⁽⁷⁾	57.1	86.6 ⁽⁶⁾	48.0	78.3 ⁽⁶⁾	41.0	68.1 ⁽⁶⁾				
	BV	167.0 ⁽⁶⁾	153.0 ⁽⁵⁾	138.0 ⁽⁴⁾	122.0 ⁽⁶⁾	122.0 ⁽⁴⁾	107.0 ⁽³⁾	107.0 ⁽³⁾	49.5	91.2 ⁽³⁾	43.0	78.1 ⁽³⁾	36.2	64.3 ⁽³⁾				
	BW	167.0 ⁽⁶⁾	153.0 ⁽⁵⁾	140.0 ⁽⁴⁾	126.0 ⁽⁶⁾	126.0 ⁽⁴⁾	112.0 ⁽³⁾	112.0 ⁽³⁾	52.7	94.3 ⁽³⁾	45.8	80.7 ⁽³⁾	38.6	67.7 ⁽³⁾				
380	B	85.3 ⁽¹¹⁾	90.2 ⁽¹¹⁾	95.2 ⁽¹¹⁾	95.0 ⁽¹¹⁾	95.0 ⁽¹¹⁾	87.4 ⁽⁹⁾	87.4 ⁽⁹⁾	80.7 ⁽⁷⁾	80.7 ⁽⁷⁾	44.8	73.7 ⁽⁶⁾	37.3	64.1 ⁽⁶⁾				
	BV	156.0 ⁽¹¹⁾	147.0 ⁽⁹⁾	134.0 ⁽⁵⁾	120.0 ⁽⁴⁾	120.0 ⁽⁴⁾	105.0 ⁽³⁾	105.0 ⁽³⁾	90.3 ⁽³⁾	90.3 ⁽³⁾	39.6	77.3 ⁽³⁾	3					

SDWB/SDWBV/SDWBW

S 335

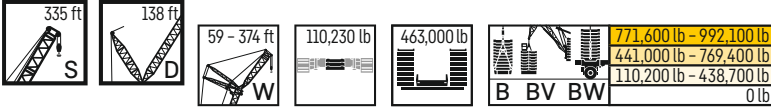

		S 335 ft																	
ft	ft	W 59 ft		W 79 ft		W 98 ft		W 118 ft		W 138 ft		W 158 ft		W 177 ft		W 197 ft		W 217 ft	
		87°/85	WVmax	87°/85	WVmax	87°/85	WVmax	87°/85	WVmax	87°/85	WVmax	87°/85	WVmax	87°/85	WVmax	87°/85	WVmax	87°/85	WVmax
50	B	547.0*	550.0 ⁽¹⁾																
	BV																		
	BW	550.0*	554.0 ⁽¹⁾																
60	B	517.0*	545.0 ⁽¹⁾	471.0*	485.0 ⁽¹⁾	439.0*	440.0 ⁽¹⁾												
	BV																		
	BW	520.0*	549.0 ⁽¹⁾	473.0*	487.0 ⁽¹⁾	441.0*	443.0 ⁽¹⁾												
70	B	526.0	544.0 ⁽¹⁾	480.0	480.0	419.0*	435.0 ⁽¹⁾	384.0*	390.0 ⁽¹⁾	349.0*	350.0 ⁽¹⁾								
	BV	522.0	535.0 ⁽¹⁾	476.0	479.0 ⁽¹⁾														
	BW	525.0	540.0 ⁽¹⁾	478.0	479.0 ⁽¹⁾	422.0*	440.0 ⁽¹⁾	385.0*	393.0 ⁽¹⁾	352.0*	353.0 ⁽¹⁾								
80	B	494.0	541.0 ⁽¹⁾	453.0	467.0 ⁽²⁾	421.0	431.0 ⁽¹⁾	385.0	386.0 ⁽¹⁾	333.0*	345.0 ⁽¹⁾	305.0*	311.0 ⁽¹⁾	281.0*	281.0*	249.0*	249.0*		
	BV	490.0	523.0 ⁽¹⁾	448.0	467.0 ⁽²⁾	423.0	430.0 ⁽¹⁾	387.0	387.0										
	BW	492.0	530.0 ⁽¹⁾	451.0	461.0 ⁽²⁾	425.0	433.0 ⁽¹⁾	388.0	388.0	336.0*	348.0 ⁽¹⁾	309.0*	314.0 ⁽¹⁾	282.0*	283.0 ⁽¹⁾	246.0*	250.0 ⁽¹⁾	225.0*	225.0*
90	B	469.0	537.0 ⁽¹⁾	426.0	465.0 ⁽²⁾	402.0	428.0 ⁽¹⁾	369.0	383.0 ⁽¹⁾	336.0	341.0 ⁽¹⁾	308.0	308.0	270.0*	277.0 ⁽¹⁾	246.0*	250.0 ⁽¹⁾	226.0*	226.0*
	BV	465.0	511.0 ⁽¹⁾	419.0	456.0 ⁽²⁾	402.0	421.0 ⁽¹⁾	369.0	379.0 ⁽¹⁾	337.0	341.0 ⁽¹⁾	309.0	309.0						
	BW	468.0	521.0 ⁽¹⁾	422.0	450.0 ⁽²⁾	404.0	423.0 ⁽¹⁾	370.0	380.0 ⁽¹⁾	339.0	343.0 ⁽¹⁾	311.0	311.0	271.0*	280.0 ⁽¹⁾	248.0*	253.0 ⁽¹⁾	226.0*	226.0*
100	B	528.0 ⁽¹⁾	402.0	462.0 ⁽²⁾	382.0	424.0 ⁽¹⁾	352.0	380.0 ⁽¹⁾	323.0	338.0 ⁽¹⁾	295.0	304.0 ⁽¹⁾	272.0	274.0 ⁽¹⁾	248.0	248.0	216.0*	222.0 ⁽¹⁾	
	BV	502.0 ⁽¹⁾	394.0	445.0 ⁽¹⁾	380.0	412.0 ⁽¹⁾	351.0	372.0 ⁽¹⁾	322.0	334.0 ⁽¹⁾	296.0	302.0 ⁽¹⁾	272.0	274.0 ⁽¹⁾	249.0	249.0			
	BW	512.0 ⁽¹⁾	396.0	440.0 ⁽¹⁾	383.0	414.0 ⁽¹⁾	351.0	373.0 ⁽¹⁾	324.0	336.0 ⁽¹⁾	298.0	304.0 ⁽¹⁾	274.0	275.0 ⁽¹⁾	250.0	250.0	218.0*	224.0 ⁽¹⁾	
110	B	508.0 ⁽¹⁾	384.0	459.0 ⁽²⁾	364.0	421.0 ⁽¹⁾	336.0	377.0 ⁽¹⁾	309.0	336.0 ⁽¹⁾	285.0	302.0 ⁽¹⁾	262.0	273.0 ⁽¹⁾	240.0	240.0	218.0	218.0	
	BV	499.0 ⁽¹⁾	376.0	439.0 ⁽¹⁾	360.0	403.0 ⁽¹⁾	333.0	364.0 ⁽¹⁾	307.0	327.0 ⁽¹⁾	283.0	297.0 ⁽¹⁾	261.0	269.0 ⁽¹⁾	240.0	244.0 ⁽¹⁾	218.0	219.0 ⁽¹⁾	
	BW	502.0 ⁽¹⁾	378.0	429.0 ⁽¹⁾	363.0	405.0 ⁽¹⁾	334.0	365.0 ⁽¹⁾	309.0	330.0 ⁽¹⁾	286.0	298.0 ⁽¹⁾	263.0	267.0 ⁽¹⁾	242.0	243.0 ⁽¹⁾	221.0	221.0	
120	B	488.0 ⁽¹⁾		445.0 ⁽²⁾	347.0	410.0 ⁽¹⁾	321.0	373.0 ⁽¹⁾	295.0	334.0 ⁽¹⁾	273.0	300.0 ⁽¹⁾	252.0	271.0 ⁽¹⁾	232.0	233.0 ⁽¹⁾	211.0	211.0	
	BV	496.0 ⁽¹⁾		436.0 ⁽¹⁾	345.0	399.0 ⁽¹⁾	316.0	357.0 ⁽¹⁾	292.0	321.0 ⁽¹⁾	271.0	291.0 ⁽¹⁾	250.0	263.0 ⁽¹⁾	231.0	239.0 ⁽¹⁾	210.0	215.0 ⁽¹⁾	
	BW	493.0 ⁽¹⁾		427.0 ⁽¹⁾	347.0	401.0 ⁽¹⁾	317.0	357.0 ⁽¹⁾	294.0	324.0 ⁽¹⁾	273.0	292.0 ⁽¹⁾	251.0	258.0 ⁽¹⁾	233.0	236.0 ⁽¹⁾	213.0	213.0	
130	B	468.0 ⁽¹⁾		431.0 ⁽¹⁾	334.0	397.0 ⁽¹⁾	306.0	364.0 ⁽¹⁾	282.0	329.0 ⁽¹⁾	261.0	299.0 ⁽¹⁾	242.0	270.0 ⁽¹⁾	224.0	232.0 ⁽¹⁾	203.0	207.0 ⁽¹⁾	
	BV	492.0 ⁽¹⁾		433.0 ⁽¹⁾	331.0	396.0 ⁽¹⁾	304.0	354.0 ⁽¹⁾	278.0	316.0 ⁽¹⁾	258.0	285.0 ⁽¹⁾	239.0	258.0 ⁽¹⁾	222.0	235.0 ⁽¹⁾	202.0	211.0 ⁽¹⁾	
	BW	486.0 ⁽¹⁾		424.0 ⁽¹⁾	334.0	397.0 ⁽¹⁾	304.0	354.0 ⁽¹⁾	280.0	317.0 ⁽¹⁾	261.0	287.0 ⁽¹⁾	241.0	254.0 ⁽¹⁾	224.0	230.0 ⁽¹⁾	204.0	207.0 ⁽¹⁾	
140	B	443.0 ⁽¹⁾		417.0 ⁽¹⁾		385.0 ⁽¹⁾	293.0	355.0 ⁽¹⁾	270.0	322.0 ⁽¹⁾	249.0	290.0 ⁽¹⁾	232.0	268.0 ⁽¹⁾	216.0	232.0 ⁽¹⁾	196.0	206.0 ⁽¹⁾	
	BV	481.0 ⁽¹⁾		428.0 ⁽¹⁾		393.0 ⁽¹⁾	291.0	351.0 ⁽¹⁾	265.0	313.0 ⁽¹⁾	246.0	282.0 ⁽¹⁾	229.0	253.0 ⁽¹⁾	212.0	231.0 ⁽¹⁾	194.0	207.0 ⁽¹⁾	
	BW	477.0 ⁽¹⁾		422.0 ⁽¹⁾		394.0 ⁽¹⁾	292.0	351.0 ⁽¹⁾	267.0	311.0 ⁽¹⁾	247.0	279.0 ⁽¹⁾	231.0	249.0 ⁽¹⁾	215.0	226.0 ⁽¹⁾	195.0	203.0 ⁽¹⁾	
150	B	423.0 ⁽¹⁾		397.0 ⁽¹⁾		371.0 ⁽¹⁾	283.0	345.0 ⁽¹⁾	258.0	315.0 ⁽¹⁾	239.0	285.0 ⁽¹⁾	223.0	259.0 ⁽¹⁾	206.0	231.0 ⁽¹⁾	189.0	206.0 ⁽¹⁾	
	BV	470.0 ⁽¹⁾		416.0 ⁽¹⁾		389.0 ⁽¹⁾	278.0	348.0 ⁽¹⁾	254.0	310.0 ⁽¹⁾	235.0	279.0 ⁽¹⁾	218.0	251.0 ⁽¹⁾	203.0	227.0 ⁽¹⁾	186.0	203.0 ⁽¹⁾	
	BW	466.0 ⁽¹⁾		417.0 ⁽¹⁾		390.0 ⁽¹⁾	279.0	347.0 ⁽¹⁾	255.0	305.0 ⁽¹⁾	236.0	272.0 ⁽¹⁾	220.0	245.0 ⁽¹⁾	204.0	223.0 ⁽¹⁾	188.0	200.0 ⁽¹⁾	
160	B	399.0 ⁽¹⁾		374.0 ⁽¹⁾		355.0 ⁽¹⁾		334.0 ⁽¹⁾	247.0	308.0 ⁽¹⁾	229.0	279.0 ⁽¹⁾	214.0	255.0 ⁽¹⁾	197.0	231.0 ⁽¹⁾	182.0	205.0 ⁽¹⁾	
	BV	459.0 ⁽¹⁾		410.0 ⁽¹⁾		384.0 ⁽¹⁾		345.0 ⁽¹⁾	246.0	307.0 ⁽¹⁾	227.0	276.0 ⁽¹⁾	209.0	248.0 ⁽¹⁾	194.0	224.0 ⁽¹⁾	178.0	200.0 ⁽¹⁾	
	BW	455.0 ⁽¹⁾		411.0 ⁽¹⁾		384.0 ⁽¹⁾		344.0 ⁽¹⁾	247.0	301.0 ⁽¹⁾	228.0	271.0 ⁽¹⁾	211.0	242.0 ⁽¹⁾	195.0	219.0 ⁽¹⁾	180.0	196.0 ⁽¹⁾	
170	B	372.0 ⁽¹⁾		359.0 ⁽¹⁾		339.0 ⁽¹⁾		321.0 ⁽¹⁾	240.0	296.0 ⁽¹⁾	220.0	274.0 ⁽¹⁾	204.0	251.0 ⁽¹⁾	190.0	228.0 ⁽¹⁾	174.0	205.0 ⁽¹⁾	
	BV	448.0 ⁽¹⁾		404.0 ⁽¹⁾		378.0 ⁽¹⁾		342.0 ⁽¹⁾	236.0	305.0 ⁽¹⁾	218.0	273.0 ⁽¹⁾	199.0	246.0 ⁽¹⁾	186.0	222.0 ⁽¹⁾	171.0	198.0 ⁽¹⁾	
	BW	445.0 ⁽¹⁾		405.0 ⁽¹⁾		379.0 ⁽¹⁾		340.0 ⁽¹⁾	238.0	299.0 ⁽¹⁾	220.0	269.0 ⁽¹⁾	201.0	240.0 ⁽¹⁾	187.0	217.0 ⁽¹⁾	173.0	193.0 ⁽¹⁾	
180	B	346.0 ⁽¹⁾		340.0 ⁽¹⁾		326.0 ⁽¹⁾		306.0 ⁽¹⁾	213.0	285.0 ⁽¹⁾	213.0	268.0 ⁽¹⁾	196.0	246.0 ⁽¹⁾	183.0	225.0 ⁽¹⁾	168.0	202.0 ⁽¹⁾	
	BV	437.0 ⁽¹⁾		398.0 ⁽¹⁾		373.0 ⁽¹⁾		340.0 ⁽¹⁾	209.0	303.0 ⁽¹⁾	209.0	271.0 ⁽¹⁾	192.0	243.0 ⁽¹⁾	177.0	219.0 ⁽¹⁾	163.0	196.0 ⁽¹⁾	
	BW	436.0 ⁽¹⁾		399.0 ⁽¹⁾		373.0 ⁽¹⁾		337.0 ⁽¹⁾	211.0	297.0 ⁽¹⁾	211.0	267.0 ⁽¹⁾	195.0	239.0 ⁽¹⁾	179.0	216.0 ⁽¹⁾	166.0	191.0 ⁽¹⁾	
190	B	319.0 ⁽¹⁾		319.0 ⁽¹⁾		313.0 ⁽¹⁾		291.0 ⁽¹⁾	206.0	274.0 ⁽¹⁾	206.0	259.0 ⁽¹⁾	188.0	241.0 ⁽¹⁾	175.0	222.0 ⁽¹⁾	162.0	199.0 ⁽¹⁾	
	BV	426.0 ⁽¹⁾		392.0 ⁽¹⁾		368.0 ⁽¹⁾		338.0 ⁽¹⁾	201.0	301.0 ⁽¹⁾	201.0	270.0 ⁽¹⁾	186.0	241.0 ⁽¹⁾	172.0	217.0 ⁽¹⁾	156.0	193.0 ⁽¹⁾	
	BW	426.0 ⁽¹⁾		393.0 ⁽¹⁾		368.0 ⁽¹⁾		334.0 ⁽¹⁾	202.0	294.0 ⁽¹⁾	202.0	265.0 ⁽¹⁾	188.0	237.0 ⁽¹⁾	174.0	214.0 ⁽¹⁾	158.0	190.0 ⁽¹⁾	
200	B	293.0 ⁽¹⁾		297.0 ⁽¹⁾		294.0 ⁽¹⁾		280.0 ⁽¹⁾	264.0 ⁽¹⁾	264.0 ⁽¹⁾	250.0 ⁽¹⁾	250.0 ⁽¹⁾	182.0	234.0 ⁽¹⁾	169.0	219.0 ⁽¹⁾	155.0	195.0 ⁽¹⁾	
	BV	406.0 ⁽¹⁾		386.0 ⁽¹⁾		363.0 ⁽¹⁾		335.0 ⁽¹⁾	299.0 ⁽¹⁾	299.0 ⁽¹⁾	268.0 ⁽¹⁾	268.0 ⁽¹⁾	178.0	240.0 ⁽¹⁾	166.0	211.0 ⁽¹⁾	150.0	191.0 ⁽¹⁾	
	BW	405.0 ⁽¹⁾		387.0 ⁽¹⁾		362.0 ⁽¹⁾		330.0 ⁽¹⁾	292.0 ⁽¹⁾	292.0 ⁽¹⁾	264.0 ⁽¹⁾	264.0 ⁽¹⁾	180.0	236.0 ⁽¹⁾	169.0	213.0 ⁽¹⁾	151.0	188.0 ⁽¹⁾	
220	B			255.0 ⁽¹⁾		295.0 ⁽¹⁾		253.0 ⁽¹⁾	244.0 ⁽¹⁾	244.0 ⁽¹⁾	231.0 ⁽¹⁾	231.0 ⁽¹⁾	220.0 ⁽¹⁾	220.0 ⁽¹⁾	158.0	207.0 ⁽¹⁾	142.0	187.0 ⁽¹⁾	
	BV			360.0 ⁽¹⁾		347.0 ⁽¹⁾		330.0 ⁽¹⁾	295.0 ⁽¹⁾	295.0 ⁽¹⁾	265.0 ⁽¹⁾	265.0 ⁽¹⁾	237.0 ⁽¹⁾	237.0 ⁽¹⁾	152.0	209.0 ⁽¹⁾	140.0	184.0 ⁽¹⁾	
	BW			359.0 ⁽¹⁾		346.0 ⁽¹⁾		323.0 ⁽¹⁾	287.0 ⁽¹⁾	287.0 ⁽¹⁾	260.0 ⁽¹⁾	260.0 ⁽¹⁾	234.0 ⁽¹⁾	234.0 ⁽¹⁾	154.0	210.0 ⁽¹⁾	141.0	185.0 ⁽¹⁾	
240	B					217.0 ⁽¹⁾		221.0 ⁽¹⁾	222.0 ⁽¹⁾	222.0 ⁽¹⁾	216.0 ⁽¹⁾	216.0 ⁽¹⁾	203.0 ⁽¹⁾	203.0 ⁽¹⁾		187.0 ⁽¹⁾	133.0	175.0 ⁽¹⁾	
	BV			314.0 ⁽¹⁾		314.0 ⁽¹⁾		309.0 ⁽¹⁾	292.0 ⁽¹⁾	292.0 ⁽¹⁾	261.0 ⁽¹⁾	261.0 ⁽¹⁾	234.0 ⁽¹⁾	234.0 ⁽¹⁾		207.0 ⁽¹⁾	129.0	183.0 ⁽¹⁾	
	BW			315.0 ⁽¹⁾		315.0 ⁽¹⁾		307.0 ⁽¹⁾	282.0 ⁽¹⁾	282.0 ⁽¹⁾	257.0 ⁽¹⁾	257.0 ⁽¹⁾	232.0 ⁽¹⁾	232.0 ⁽¹⁾		208.0 ⁽¹⁾	131.0	184.0 ⁽¹⁾	
260	B					180.0 ⁽¹⁾		190.0 ⁽¹⁾	194.0 ⁽¹⁾	194.0 ⁽¹⁾	171.0 ⁽¹⁾	171.0 ⁽¹⁾	160.0 ⁽¹⁾	160.0 ⁽¹⁾		175.0 ⁽¹⁾		167.0 ⁽¹⁾	
	BV			268.0 ⁽															

SDWB/SDWBV/SDWBW

S 335

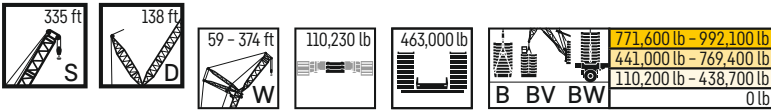

		S 335 ft															
ft	B BV BW	W 236 ft		W 256 ft		W 276 ft		W 295 ft		W 315 ft		W 335 ft		W 354 ft		W 374 ft	
		87°/85	WVmax	87°/85	WVmax	87°/85	WVmax	87°/85	WVmax	87°/85	WVmax	87°/85	WVmax	87°/85	WVmax	87°/85	WVmax
90	B	203.0*	203.0*														
	BV	203.0*	203.0*														
	BW	198.0*	199.0 ⁽¹⁾	179.0*	180.0 ⁽¹⁾	164.0*	164.0*										
100	B	197.0*	199.0 ⁽¹⁾	180.0*	180.0*	164.0*	164.0*										
	BV	199.0	199.0	173.0*	177.0 ⁽¹⁾	158.0*	160.0 ⁽¹⁾	140.0*	141.0 ⁽¹⁾	127.0*	127.0*						
	BW	198.0	198.0														
110	B	199.0	199.0	174.0*	178.0 ⁽¹⁾	159.0*	161.0 ⁽¹⁾	141.0*	141.0*	127.0*	127.0*						
	BV	198.0	198.0	175.0	175.0	151.0*	151.0*	136.0*	139.0 ⁽¹⁾	123.0*	124.0 ⁽¹⁾						
	BW	192.0	199.0	172.0	172.0	155.0	155.0										
120	B	193.0	196.0 ⁽¹⁾	175.0	175.0	150.0*	150.0*	137.0*	140.0 ⁽¹⁾	124.0*	125.0 ⁽¹⁾	110.0*	110.0*	94.6*	94.6*		
	BV	191.0	193.0 ⁽¹⁾	172.0	172.0	155.0	155.0										
	BW	192.0	192.0	176.0	176.0	152.0*	158.0 ⁽¹⁾										
130	B	187.0	195.0 ⁽¹⁾	170.0	170.0	153.0	153.0	138.0	138.0	119.0*	122.0 ⁽¹⁾						
	BV	184.0	190.0 ⁽¹⁾	166.0	169.0 ⁽¹⁾	150.0	151.0 ⁽¹⁾	134.0	134.0								
	BW	186.0	186.0	171.0	171.0	154.0	154.0	139.0	139.0	120.0*	124.0 ⁽¹⁾	107.0*	109.0 ⁽¹⁾	92.3*	93.0 ⁽¹⁾	75.1*	75.1*
140	B	181.0	194.0 ⁽¹⁾	165.0	165.0	148.0	148.0	133.0	133.0	121.0	121.0						
	BV	178.0	186.0 ⁽¹⁾	160.0	166.0 ⁽¹⁾	145.0	149.0 ⁽¹⁾	130.0	132.0 ⁽¹⁾	116.0	116.0	102.0	102.0				
	BW	179.0	182.0 ⁽²⁾	165.0	165.0	149.0	149.0	135.0	135.0	122.0	122.0	108.0	108.0	89.4*	92.1 ⁽¹⁾	72.5*	73.8 ⁽¹⁾
150	B	176.0	192.0 ⁽¹⁾	159.0	164.0 ⁽²⁾	143.0	144.0 ⁽²⁾	130.0	130.0	117.0	117.0						
	BV	171.0	183.0 ⁽¹⁾	154.0	163.0 ⁽¹⁾	140.0	146.0 ⁽¹⁾	126.0	129.0 ⁽¹⁾	112.0	114.0 ⁽¹⁾	98.4	99.2 ⁽¹⁾	86.1	86.3 ⁽¹⁾	72.9	72.9
	BW	173.0	179.0 ⁽²⁾	160.0	162.0 ⁽²⁾	144.0	145.0 ⁽²⁾	131.0	131.0	118.0	118.0	105.0	105.0	90.9	90.9	72.9	72.9
160	B	170.0	191.0 ⁽¹⁾	153.0	164.0 ⁽²⁾	139.0	144.0 ⁽²⁾	126.0	127.0 ⁽²⁾	114.0	114.0						
	BV	164.0	179.0 ⁽¹⁾	148.0	160.0 ⁽¹⁾	135.0	143.0 ⁽¹⁾	121.0	127.0 ⁽¹⁾	108.0	112.0 ⁽¹⁾	95.1	97.1 ⁽¹⁾	83.3	84.4 ⁽¹⁾	70.5	70.9 ⁽¹⁾
	BW	166.0	176.0 ⁽²⁾	153.0	159.0 ⁽²⁾	139.0	142.0 ⁽²⁾	126.0	127.0 ⁽²⁾	115.0	115.0	100.0	100.0	88.3	88.3	70.9	70.9
170	B	164.0	185.0 ⁽²⁾	147.0	164.0 ⁽²⁾	135.0	144.0 ⁽²⁾	122.0	127.0 ⁽²⁾	110.0	112.0 ⁽²⁾						
	BV	157.0	177.0 ⁽¹⁾	142.0	156.0 ⁽¹⁾	130.0	140.0 ⁽¹⁾	117.0	124.0 ⁽¹⁾	104.0	110.0 ⁽¹⁾	91.7	95.0 ⁽¹⁾	80.4	82.5 ⁽¹⁾	67.9	69.3 ⁽¹⁾
	BW	160.0	174.0 ⁽²⁾	146.0	156.0 ⁽²⁾	134.0	140.0 ⁽²⁾	122.0	125.0 ⁽²⁾	111.0	112.0 ⁽²⁾	95.8	95.8	85.6	85.6	68.4	68.7 ⁽¹⁾
180	B	156.0	184.0 ⁽²⁾	142.0	163.0 ⁽²⁾	130.0	144.0 ⁽²⁾	118.0	127.0 ⁽²⁾	106.0	112.0 ⁽²⁾						
	BV	150.0	175.0 ⁽¹⁾	136.0	155.0 ⁽¹⁾	124.0	138.0 ⁽¹⁾	112.0	122.0 ⁽¹⁾	100.0	107.0 ⁽¹⁾	88.1	93.0 ⁽¹⁾	77.3	80.6 ⁽¹⁾	65.4	67.7 ⁽¹⁾
	BW	152.0	171.0 ⁽²⁾	140.0	153.0 ⁽²⁾	129.0	138.0 ⁽²⁾	118.0	124.0 ⁽²⁾	107.0	110.0 ⁽²⁾	92.7	94.2 ⁽²⁾	82.9	83.3 ⁽²⁾	65.6	66.6 ⁽¹⁾
190	B	149.0	182.0 ⁽²⁾	137.0	163.0 ⁽²⁾	126.0	143.0 ⁽²⁾	114.0	127.0 ⁽²⁾	101.0	112.0 ⁽²⁾						
	BV	143.0	172.0 ⁽¹⁾	130.0	153.0 ⁽¹⁾	119.0	136.0 ⁽¹⁾	107.0	119.0 ⁽¹⁾	96.2	105.0 ⁽¹⁾	84.6	90.0 ⁽¹⁾	74.2	78.8 ⁽¹⁾	63.0	66.1 ⁽¹⁾
	BW	145.0	170.0 ⁽²⁾	135.0	150.0 ⁽²⁾	124.0	136.0 ⁽²⁾	113.0	122.0 ⁽²⁾	101.0	108.0 ⁽²⁾	89.4	92.6 ⁽²⁾	80.2	81.8 ⁽²⁾	63.0	64.5 ⁽¹⁾
200	B	144.0	179.0 ⁽²⁾	131.0	161.0 ⁽²⁾	121.0	143.0 ⁽²⁾	110.0	126.0 ⁽²⁾	96.8	112.0 ⁽²⁾						
	BV	137.0	170.0 ⁽¹⁾	125.0	151.0 ⁽¹⁾	114.0	134.0 ⁽¹⁾	103.0	118.0 ⁽¹⁾	92.2	103.0 ⁽¹⁾	81.0	86.5 ⁽²⁾	71.0	76.9 ⁽¹⁾	60.6	64.4 ⁽¹⁾
	BW	139.0	168.0 ⁽²⁾	129.0	149.0 ⁽²⁾	120.0	134.0 ⁽²⁾	109.0	120.0 ⁽²⁾	96.4	106.0 ⁽²⁾	86.2	91.1 ⁽²⁾	77.4	80.5 ⁽²⁾	60.5	62.9 ⁽²⁾
220	B	133.0	174.0 ⁽²⁾	122.0	157.0 ⁽²⁾	112.0	141.0 ⁽²⁾	99.7	125.0 ⁽²⁾	89.9	111.0 ⁽²⁾						
	BV	128.0	163.0 ⁽¹⁾	114.0	144.0 ⁽¹⁾	104.0	130.0 ⁽¹⁾	94.0	114.0 ⁽¹⁾	84.3	100.0 ⁽¹⁾	73.9	83.0 ⁽²⁾	64.9	71.4 ⁽²⁾	55.8	59.9 ⁽²⁾
	BW	130.0	166.0 ⁽²⁾	119.0	147.0 ⁽²⁾	110.0	132.0 ⁽²⁾	98.1	117.0 ⁽²⁾	88.9	102.0 ⁽²⁾	79.7	88.0 ⁽²⁾	71.6	77.7 ⁽²⁾	55.1	61.1 ⁽²⁾
240	B	124.0	165.0 ⁽³⁾	113.0	152.0 ⁽²⁾	101.0	138.0 ⁽²⁾	91.4	123.0 ⁽²⁾	82.9	109.0 ⁽²⁾						
	BV	118.0	162.0 ⁽²⁾	107.0	142.0 ⁽²⁾	95.7	125.0 ⁽²⁾	85.7	109.0 ⁽²⁾	76.7	96.7 ⁽¹⁾	67.1	80.8 ⁽²⁾	59.5	68.7 ⁽²⁾	51.0	57.4 ⁽²⁾
	BW	121.0	164.0 ⁽²⁾	113.0	144.0 ⁽²⁾	99.0	129.0 ⁽²⁾	90.1	115.0 ⁽²⁾	81.9	99.6 ⁽²⁾	73.5	85.9 ⁽²⁾	65.7	74.9 ⁽²⁾	50.0	59.3 ⁽²⁾
260	B	117.0	156.0 ⁽⁴⁾	103.0	142.0 ⁽³⁾	94.1	132.0 ⁽³⁾	84.5	120.0 ⁽³⁾	76.8	107.0 ⁽²⁾						
	BV	108.0	161.0 ⁽²⁾	97.7	141.0 ⁽²⁾	89.5	124.0 ⁽²⁾	78.0	107.0 ⁽²⁾	69.6	93.0 ⁽²⁾	61.2	79.0 ⁽²⁾	54.3	67.1 ⁽²⁾	46.3	55.9 ⁽²⁾
	BW	112.0	163.0 ⁽²⁾	102.0	143.0 ⁽²⁾	93.3	128.0 ⁽²⁾	83.8	113.0 ⁽²⁾	75.4	96.8 ⁽²⁾	67.5	84.1 ⁽²⁾	59.6	72.3 ⁽²⁾	44.9	56.1 ⁽²⁾
280	B		143.0 ⁽⁶⁾	96.0	133.0 ⁽⁵⁾	87.0	125.0 ⁽⁴⁾	78.8	116.0 ⁽³⁾	70.8	101.0 ⁽³⁾						
	BV		160.0 ⁽²⁾	89.7	140.0 ⁽²⁾	81.4	123.0 ⁽²⁾	72.6	106.0 ⁽²⁾	63.4	91.7 ⁽²⁾	56.0	77.3 ⁽²⁾	49.4	65.5 ⁽²⁾	41.8	54.5 ⁽²⁾
	BW		162.0 ⁽²⁾	93.1	142.0 ⁽²⁾	85.8	127.0 ⁽²⁾	78.1	111.0 ⁽²⁾	69.6	94.2 ⁽²⁾	61.8	82.2 ⁽²⁾	54.1	69.8 ⁽²⁾	39.8	55.1 ⁽³⁾
300	B		135.0 ⁽⁷⁾		127.0 ⁽⁶⁾	82.1	119.0 ⁽⁵⁾	73.7	110.0 ⁽⁴⁾	66.0	95.6 ⁽⁴⁾						
	BV		159.0 ⁽²⁾		139.0 ⁽²⁾	74.5	122.0 ⁽²⁾	65.9	106.0 ⁽²⁾	59.3	91.0 ⁽²⁾	51.2	80.8 ⁽²⁾	44.8	64.4 ⁽²⁾	37.6	53.1 ⁽²⁾
	BW		161.0 ⁽²⁾		141.0 ⁽²⁾	79.3	126.0 ⁽²⁾	71.8	110.0 ⁽²⁾	65.2	91.7 ⁽²⁾	56.8	78.4 ⁽³⁾	47.9	67.8 ⁽³⁾	35.0	53.3 ⁽³⁾
320	B		127.0 ⁽¹⁰⁾		118.0 ⁽⁸⁾		112.0 ⁽⁶⁾	69.1	102.0 ⁽⁵⁾	61.4	91.2 ⁽⁴⁾						
	BV		156.0 ⁽³⁾		138.0 ⁽²⁾		121.0 ⁽²⁾	60.7	105.0 ⁽²⁾	54.0	90.2 ⁽²⁾	47.5	75.9 ⁽²⁾	40.9	63.9 ⁽²⁾	33.6	52.6 ⁽²⁾
	BW		158.0 ⁽³⁾		140.0 ⁽²⁾		125.0 ⁽²⁾	66.1	109.0 ⁽²⁾	59.4	91.4 ⁽³⁾	52.3	77.6 ⁽³⁾	44.1	66.7 ⁽³⁾	30.7	51.5 ⁽³⁾
340	B		115.0 ⁽¹¹⁾		112.0 ⁽¹⁰⁾		103.0 ⁽⁸⁾		93.1 ⁽⁶⁾	57.7	85.9 ⁽⁶⁾						
	BV		153.0 ⁽⁴⁾		136.0 ⁽³⁾		120.0 ⁽²⁾		104.0 ⁽²⁾	49.8	89.5 ⁽²⁾	42.9	75.2 ⁽²⁾	37.2	63.3 ⁽²⁾	30.3	52.0 ⁽²⁾
	BW		152.0 ⁽⁴⁾		139.0 ⁽³⁾		125.0 ⁽²⁾		108.0 ⁽³⁾	53.7	91.6 ⁽³⁾	45.8	76.8 ⁽³⁾	40.3	64.6 ⁽³⁾	27.0	50.3 ⁽⁴⁾
360	B		98.1 ⁽¹¹⁾		100.0 ⁽¹¹⁾		96.4 ⁽¹⁰⁾		89.2 ⁽⁶⁾		81.6 ⁽⁷⁾						
	BV		147.0 ⁽⁶⁾		132.0 ⁽⁴⁾		118.0 ⁽³⁾		103.0 ⁽³⁾		88.7 ⁽²⁾	39.3	74.4 ⁽²⁾	33.2	62.7 ⁽²⁾	26.7	51.5 ⁽⁴⁾
	BW		147.0 ⁽⁶⁾		134.0 ⁽⁴⁾		122.0 ⁽³⁾		108.0 ⁽³⁾		91.8 ⁽³⁾	41.9	75.9 ⁽³⁾	36.1	63.9 ⁽⁴⁾	23.6	49.4 ⁽⁴⁾
380	B		80.8 ⁽¹¹⁾		83.3 ⁽¹¹⁾		85.3 ⁽¹¹⁾		84.4 ⁽¹⁰⁾		77.3 ⁽⁸⁾						
	BV		142.0 ⁽⁸⁾		128.0 ⁽⁶⁾		114.0 ⁽⁵⁾		101.0 ⁽⁴⁾		88.1 ⁽³⁾		73.7 ⁽²⁾	30.1	62.1 ⁽²⁾	23.2	51.0 ⁽³⁾
	BW		142.0 ⁽⁸⁾		131.0 ⁽⁶⁾		118.0 ⁽⁵⁾		106.0 ⁽⁴⁾		91.9 ⁽³⁾		75.9 ⁽⁴⁾	32.7	64.4 ⁽⁴⁾	21.8	48.8 ⁽⁴⁾
400	B		60.3 ⁽⁹⁾		66.3 ⁽¹¹⁾		69.9 ⁽¹¹⁾		73.0 ⁽¹¹⁾		73.2 ⁽¹⁰⁾						
	BV		127.0 ⁽⁹⁾		123.0 ⁽⁹⁾		112.0 ⁽⁶⁾		98.6 ⁽⁶⁾		86.6 ⁽⁴⁾		73.6 ⁽³⁾		61.8 ⁽³⁾	20.5	50.5 ⁽²⁾
	BW		127.0 ⁽⁹⁾		126.0 ⁽⁹⁾		116.0 ⁽⁶⁾		102.0 ⁽⁵⁾		89.9 ⁽⁴⁾		76.6 ⁽⁴⁾		65.0 ⁽⁴⁾	21.5	48.3 ⁽⁴⁾
420	B		42.4 ⁽⁹⁾		46.3 ⁽⁹⁾		54.5 ⁽¹¹⁾		57.7 ⁽¹¹⁾		62.3 ⁽¹¹⁾					</	

SDWB/SDWBV/SDWBW

S 354

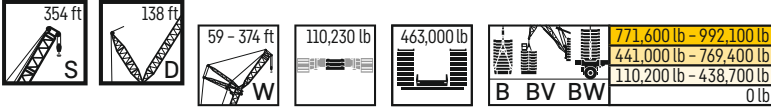

ft B BV BW	S 354 ft															
	W 236 ft		W 256 ft		W 276 ft		W 295 ft		W 315 ft		W 335 ft		W 354 ft		W 374 ft	
	87°/85	WVmax	87°/85	WVmax	87°/85	WVmax	87°/85	WVmax	87°/85	WVmax	87°/85	WVmax	87°/85	WVmax	87°/85	WVmax
100	174.0*	175.0 ⁽¹⁾	156.0*	156.0*	113.0*	113.0*										
110	168.0*	173.0 ⁽¹⁾	149.0*	153.0 ⁽¹⁾	136.0*	137.0 ⁽¹⁾	122.0*	122.0*	109.0*	109.0*						
120	164.0	165.0 ⁽¹⁾	147.0	147.0												
130	169.0	169.0	150.0	150.0	131.0*	135.0 ⁽¹⁾	118.0*	120.0 ⁽¹⁾	104.0*	106.0 ⁽¹⁾	90.9*	90.9*	77.9*	77.9*		
140	158.0	162.0 ⁽¹⁾	142.0	143.0 ⁽¹⁾	128.0	128.0	113.0	113.0								
150	163.0	163.0	145.0	145.0	132.0	132.0	119.0	119.0	99.2*	104.0 ⁽¹⁾	88.0*	89.3 ⁽¹⁾	74.9*	75.4 ⁽¹⁾	58.4*	58.4*
160	152.0	158.0 ⁽¹⁾	136.0	140.0 ⁽¹⁾	123.0	125.0 ⁽¹⁾	109.0	110.0 ⁽¹⁾	96.4	96.5 ⁽¹⁾	83.4	83.4				
170	156.0	158.0 ⁽²⁾	140.0	140.0	128.0	128.0	115.0	115.0	102.0	102.0	88.4	88.4	71.7*	73.9 ⁽¹⁾	55.9*	56.9 ⁽¹⁾
180	146.0	154.0 ⁽¹⁾	131.0	137.0 ⁽¹⁾	118.0	122.0 ⁽¹⁾	105.0	107.0 ⁽¹⁾	92.9	94.0 ⁽¹⁾	80.4	80.8 ⁽¹⁾	69.3	69.3	58.4	58.4
190	149.0	154.0 ⁽²⁾	135.0	137.0 ⁽²⁾	124.0	124.0	111.0	111.0	96.9	96.9	85.6	85.6	72.4	72.4	55.9	55.9
200	139.0	150.0 ⁽¹⁾	125.0	133.0 ⁽¹⁾	113.0	119.0 ⁽¹⁾	101.0	104.0 ⁽¹⁾	89.3	91.5 ⁽¹⁾	77.2	78.5 ⁽¹⁾	66.6	67.4 ⁽¹⁾	56.4	56.5 ⁽¹⁾
210	143.0	151.0 ⁽²⁾	130.0	134.0 ⁽²⁾	119.0	121.0 ⁽²⁾	106.0	107.0 ⁽²⁾	93.5	93.5	82.8	82.8	69.8	70.3 ⁽¹⁾	54.0	54.0
220	133.0	148.0 ⁽¹⁾	120.0	130.0 ⁽¹⁾	109.0	116.0 ⁽¹⁾	96.6	102.0 ⁽¹⁾	85.5	89.0 ⁽¹⁾	74.0	76.2 ⁽¹⁾	64.0	65.5 ⁽¹⁾	54.3	54.9 ⁽¹⁾
230	137.0	147.0 ⁽²⁾	125.0	131.0 ⁽²⁾	114.0	119.0 ⁽²⁾	101.0	104.0 ⁽²⁾	90.1	90.9 ⁽²⁾	80.0	80.0	67.4	68.3 ⁽¹⁾	51.8	52.0 ⁽¹⁾
240	127.0	148.0 ⁽¹⁾	115.0	128.0 ⁽¹⁾	104.0	113.0 ⁽¹⁾	92.4	98.9 ⁽¹⁾	81.8	86.5 ⁽¹⁾	70.7	74.0 ⁽¹⁾	61.5	63.7 ⁽¹⁾	52.1	53.3 ⁽¹⁾
250	132.0	144.0 ⁽²⁾	120.0	128.0 ⁽²⁾	109.0	116.0 ⁽²⁾	96.2	102.0 ⁽²⁾	86.7	88.9 ⁽²⁾	77.1	78.0 ⁽²⁾	65.1	66.3 ⁽¹⁾	49.4	50.2 ⁽¹⁾
260	121.0	147.0 ⁽¹⁾	109.0	128.0 ⁽¹⁾	99.2	112.0 ⁽¹⁾	88.3	96.6 ⁽¹⁾	78.1	84.0 ⁽¹⁾	67.5	71.7 ⁽¹⁾	59.0	61.8 ⁽¹⁾	49.9	51.7 ⁽¹⁾
270	126.0	142.0 ⁽²⁾	115.0	126.0 ⁽²⁾	103.0	113.0 ⁽²⁾	92.5	98.9 ⁽²⁾	83.4	87.0 ⁽²⁾	74.1	76.2 ⁽²⁾	62.5	64.3 ⁽¹⁾	47.1	48.3 ⁽¹⁾
280	116.0	147.0 ⁽¹⁾	104.0	128.0 ⁽¹⁾	94.6	112.0 ⁽¹⁾	84.1	96.1 ⁽¹⁾	74.5	82.4 ⁽¹⁾	64.5	69.4 ⁽¹⁾	56.5	59.9 ⁽¹⁾	47.6	50.0 ⁽¹⁾
290	121.0	143.0 ⁽²⁾	110.0	125.0 ⁽²⁾	98.0	111.0 ⁽²⁾	88.8	96.2 ⁽²⁾	80.2	85.0 ⁽²⁾	71.2	74.3 ⁽²⁾	59.8	62.9 ⁽²⁾	44.8	46.4 ⁽¹⁾
300	108.0	141.0 ⁽²⁾	94.8	127.0 ⁽¹⁾	85.8	111.0 ⁽¹⁾	76.1	95.2 ⁽¹⁾	67.3	81.4 ⁽¹⁾	58.8	67.9 ⁽¹⁾	51.5	57.6 ⁽¹⁾	43.2	45.9 ⁽²⁾
310	113.0	144.0 ⁽²⁾	97.7	126.0 ⁽²⁾	90.0	111.0 ⁽²⁾	81.4	93.4 ⁽²⁾	73.6	81.1 ⁽²⁾	65.2	70.7 ⁽²⁾	54.1	60.6 ⁽²⁾	39.9	44.2 ⁽²⁾
320	99.6	141.0 ⁽²⁾	89.3	123.0 ⁽²⁾	77.9	106.0 ⁽²⁾	68.6	94.2 ⁽¹⁾	61.0	80.4 ⁽¹⁾	53.4	66.8 ⁽¹⁾	46.6	56.7 ⁽¹⁾	38.8	43.0 ⁽²⁾
330	104.0	144.0 ⁽²⁾	92.9	127.0 ⁽²⁾	82.8	112.0 ⁽²⁾	74.6	93.9 ⁽²⁾	67.2	81.5 ⁽²⁾	59.5	68.3 ⁽²⁾	48.9	58.1 ⁽²⁾	34.9	42.0 ⁽²⁾
340	91.1	137.0 ⁽²⁾	81.3	120.0 ⁽²⁾	73.3	106.0 ⁽²⁾	62.5	90.9 ⁽²⁾	55.5	76.7 ⁽²⁾	48.3	63.1 ⁽²⁾	41.9	55.7 ⁽¹⁾	34.4	42.2 ⁽²⁾
350	94.0	140.0 ⁽²⁾	85.6	125.0 ⁽²⁾	78.6	111.0 ⁽²⁾	68.9	94.4 ⁽²⁾	61.2	81.9 ⁽²⁾	53.9	66.7 ⁽²⁾	43.6	54.7 ⁽²⁾	29.9	39.1 ⁽²⁾
360		133.0 ⁽²⁾	74.2	117.0 ⁽²⁾	66.6	103.0 ⁽²⁾	58.9	89.0 ⁽²⁾	50.4	76.4 ⁽²⁾	43.5	63.5 ⁽²⁾	37.4	53.2 ⁽²⁾	30.2	42.3 ⁽²⁾
370		137.0 ⁽²⁾	78.6	122.0 ⁽²⁾	72.3	108.0 ⁽²⁾	64.8	92.2 ⁽²⁾	55.7	80.9 ⁽²⁾	47.1	65.2 ⁽²⁾	39.0	51.3 ⁽²⁾	25.1	37.7 ⁽²⁾
380		130.0 ⁽²⁾		114.0 ⁽²⁾	61.2	100.0 ⁽²⁾	54.1	86.4 ⁽²⁾	47.9	74.1 ⁽²⁾	39.1	62.2 ⁽²⁾	33.1	50.0 ⁽²⁾	26.3	42.5 ⁽²⁾
390		134.0 ⁽²⁾		119.0 ⁽²⁾	66.7	104.0 ⁽²⁾	59.4	89.3 ⁽²⁾	53.1	78.2 ⁽³⁾	41.9	65.7 ⁽³⁾	34.0	53.9 ⁽³⁾	20.7	35.9 ⁽³⁾
400		126.0 ⁽²⁾		110.0 ⁽²⁾		97.1 ⁽²⁾	49.8	83.8 ⁽²⁾	43.6	71.8 ⁽²⁾	37.2	60.4 ⁽²⁾	30.0	51.4 ⁽²⁾	22.7	41.5 ⁽⁴⁾
410		130.0 ⁽²⁾		116.0 ⁽²⁾		101.0 ⁽³⁾	54.7	87.4 ⁽³⁾	46.3	76.3 ⁽³⁾	39.9	64.5 ⁽³⁾	30.0	50.8 ⁽³⁾	16.7	34.5 ⁽⁴⁾
420		122.0 ⁽³⁾		107.0 ⁽³⁾		94.4 ⁽³⁾		81.2 ⁽²⁾	40.0	69.6 ⁽²⁾	33.4	58.6 ⁽²⁾	27.8	49.8 ⁽²⁾	20.5	40.1 ⁽²⁾
430		126.0 ⁽⁴⁾		113.0 ⁽³⁾		98.3 ⁽³⁾		85.5 ⁽³⁾	42.2	74.5 ⁽³⁾	36.0	62.6 ⁽⁴⁾	26.4	50.1 ⁽⁴⁾	13.1	34.3 ⁽⁴⁾
440		118.0 ⁽⁵⁾		104.0 ⁽⁴⁾		92.1 ⁽³⁾		79.2 ⁽³⁾		67.6 ⁽³⁾	30.4	57.0 ⁽³⁾	24.5	48.2 ⁽³⁾	18.1	38.6 ⁽²⁾
450		122.0 ⁽⁵⁾		109.0 ⁽⁴⁾		95.6 ⁽³⁾		83.8 ⁽³⁾		72.6 ⁽³⁾	32.9	61.6 ⁽⁴⁾	24.1	49.7 ⁽⁴⁾		33.1 ⁽⁴⁾
460		112.0 ⁽⁷⁾		99.8 ⁽⁵⁾		89.2 ⁽⁴⁾		77.1 ⁽³⁾		65.8 ⁽³⁾		55.7 ⁽³⁾	21.7	47.0 ⁽³⁾	15.1	37.3 ⁽³⁾
470		116.0 ⁽⁷⁾		104.0 ⁽⁵⁾		92.9 ⁽⁴⁾		82.1 ⁽³⁾		71.2 ⁽⁴⁾		60.5 ⁽⁴⁾	23.1	48.7 ⁽⁴⁾		34.1 ⁽⁵⁾
480		105.0 ⁽⁹⁾		94.3 ⁽⁷⁾		84.9 ⁽⁶⁾		74.1 ⁽⁴⁾		63.8 ⁽⁴⁾		54.3 ⁽³⁾		45.8 ⁽³⁾	12.7	36.2 ⁽³⁾
490		109.0 ⁽⁹⁾		97.1 ⁽⁷⁾		88.7 ⁽⁶⁾		79.0 ⁽⁴⁾		70.1 ⁽⁴⁾		59.5 ⁽⁴⁾		47.8 ⁽⁴⁾		34.7 ⁽⁶⁾
500		93.4 ⁽⁹⁾		88.5 ⁽⁹⁾		81.3 ⁽⁷⁾		70.9 ⁽⁶⁾		61.6 ⁽⁵⁾		52.7 ⁽⁴⁾		44.5 ⁽³⁾		35.1 ⁽³⁾
510		97.3 ⁽⁹⁾		91.1 ⁽⁹⁾		85.0 ⁽⁷⁾		76.1 ⁽⁶⁾		67.6 ⁽⁵⁾		58.5 ⁽⁴⁾		46.8 ⁽⁴⁾		34.3 ⁽⁶⁾
520		82.2 ⁽⁹⁾		78.7 ⁽⁹⁾		75.5 ⁽⁹⁾		67.6 ⁽⁸⁾		59.7 ⁽⁶⁾		50.9 ⁽⁵⁾		43.3 ⁽⁴⁾		33.9 ⁽⁴⁾
530		85.5 ⁽⁹⁾		81.4 ⁽⁹⁾		79.1 ⁽⁹⁾		72.4 ⁽⁸⁾		65.4 ⁽⁶⁾		56.4 ⁽⁵⁾		45.9 ⁽⁴⁾		34.1 ⁽⁴⁾
540		67.1 ⁽⁷⁾		68.8 ⁽⁹⁾		66.9 ⁽⁹⁾		62.4 ⁽⁹⁾		57.1 ⁽⁸⁾		48.6 ⁽⁶⁾		41.6 ⁽⁵⁾		32.9 ⁽⁴⁾
550		70.3 ⁽⁷⁾		71.7 ⁽⁹⁾		70.3 ⁽⁹⁾		66.9 ⁽⁹⁾		61.9 ⁽⁸⁾		53.7 ⁽⁶⁾		44.6 ⁽⁵⁾		33.8 ⁽⁵⁾
560		51.5 ⁽⁷⁾		54.5 ⁽⁷⁾		58.4 ⁽⁹⁾		54.8 ⁽⁹⁾		52.2 ⁽⁹⁾		46.9 ⁽⁸⁾		39.3 ⁽⁷⁾		31.2 ⁽⁵⁾
570		54.8 ⁽⁷⁾		57.7 ⁽⁷⁾		61.5 ⁽⁹⁾		58.7 ⁽⁹⁾		56.6 ⁽⁹⁾		41.7 ⁽⁸⁾		41.7 ⁽⁶⁾		33.5 ⁽⁶⁾
580				39.8 ⁽⁷⁾		44.8 ⁽⁷⁾		47.2 ⁽⁹⁾		45.2 ⁽⁹⁾		41.9 ⁽⁹⁾		37.9 ⁽⁸⁾		29.7 ⁽⁷⁾
590				43.0 ⁽⁷⁾		48.0 ⁽⁷⁾		50.4 ⁽⁹⁾		49.0 ⁽⁹⁾		44.2 ⁽⁹⁾		40.3 ⁽⁸⁾		32.1 ⁽⁷⁾
600						31.0 ⁽⁷⁾		26.7 ⁽⁴⁾		38.1 ⁽⁹⁾		35.1 ⁽⁹⁾		33.1 ⁽⁹⁾		28.0 ⁽⁹⁾
610						34.1 ⁽⁷⁾		37.3 ⁽⁷⁾		41.5 ⁽⁹⁾		37.6 ⁽⁹⁾		35.5 ⁽⁹⁾		30.4 ⁽⁸⁾
620								14.7 ⁽⁴⁾		28.3 ⁽⁹⁾		28.3 ⁽⁹⁾		26.5 ⁽⁹⁾		17.1 ⁽⁵⁾
630								24.0 ⁽⁷⁾		29.1 ⁽⁹⁾		31.1 ⁽⁹⁾		29.1 ⁽⁹⁾		24.5 ⁽⁸⁾
640														19.9 ⁽⁹⁾		12.4 ⁽⁵⁾
650														22.7 ⁽⁹⁾		18.7 ⁽⁸⁾
660																12.8 ⁽⁸⁾

1) 12° 2) 17° 3) 22° 4) 27° 5) 32° 6) 37° 7) 42° 8) 47° 9) 52° 10) 57° 11) 62°

Lifting heights

Hauteurs de levage

SDWB/SDWBV/SDWBW

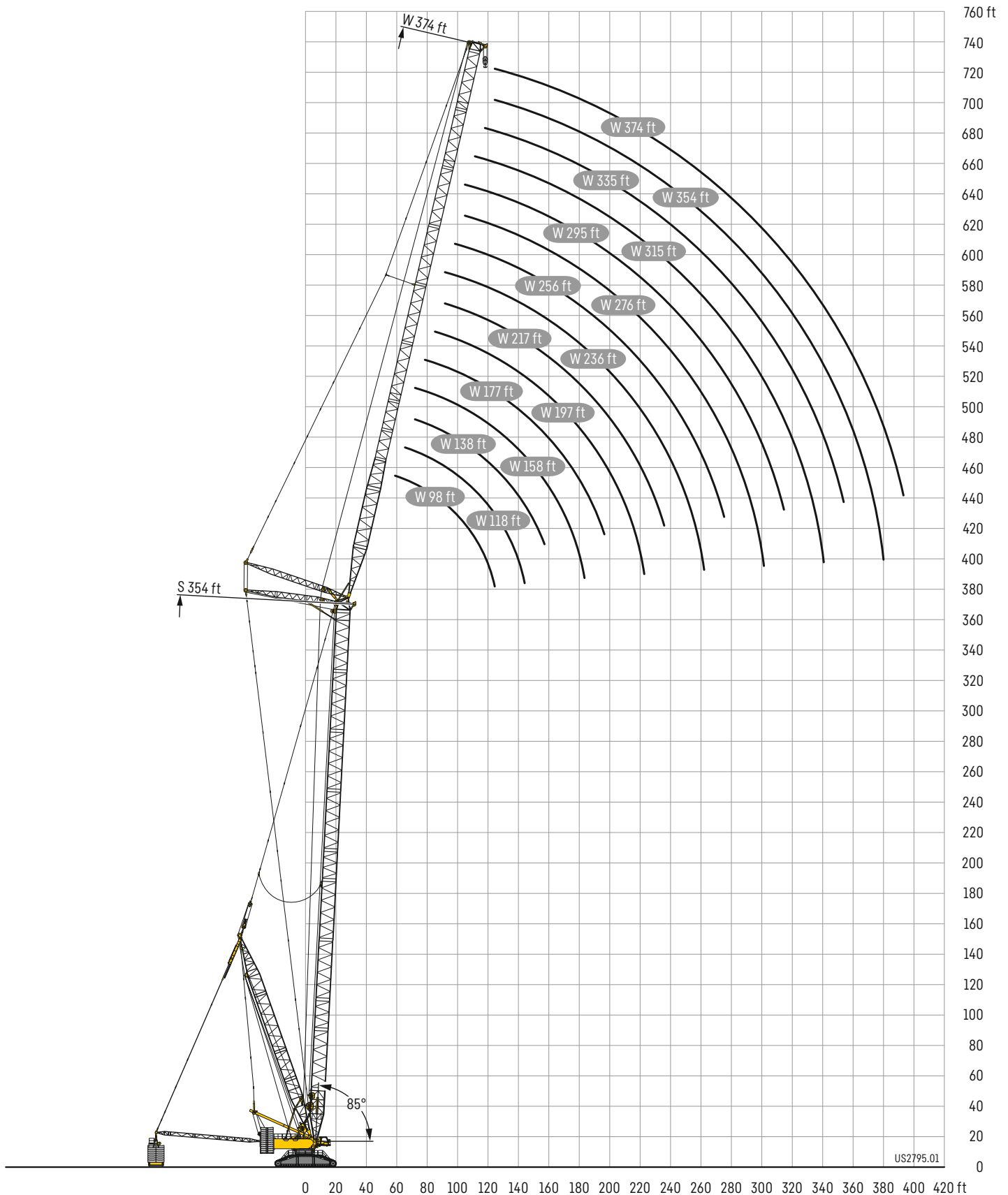

Example Exemple

Wmax

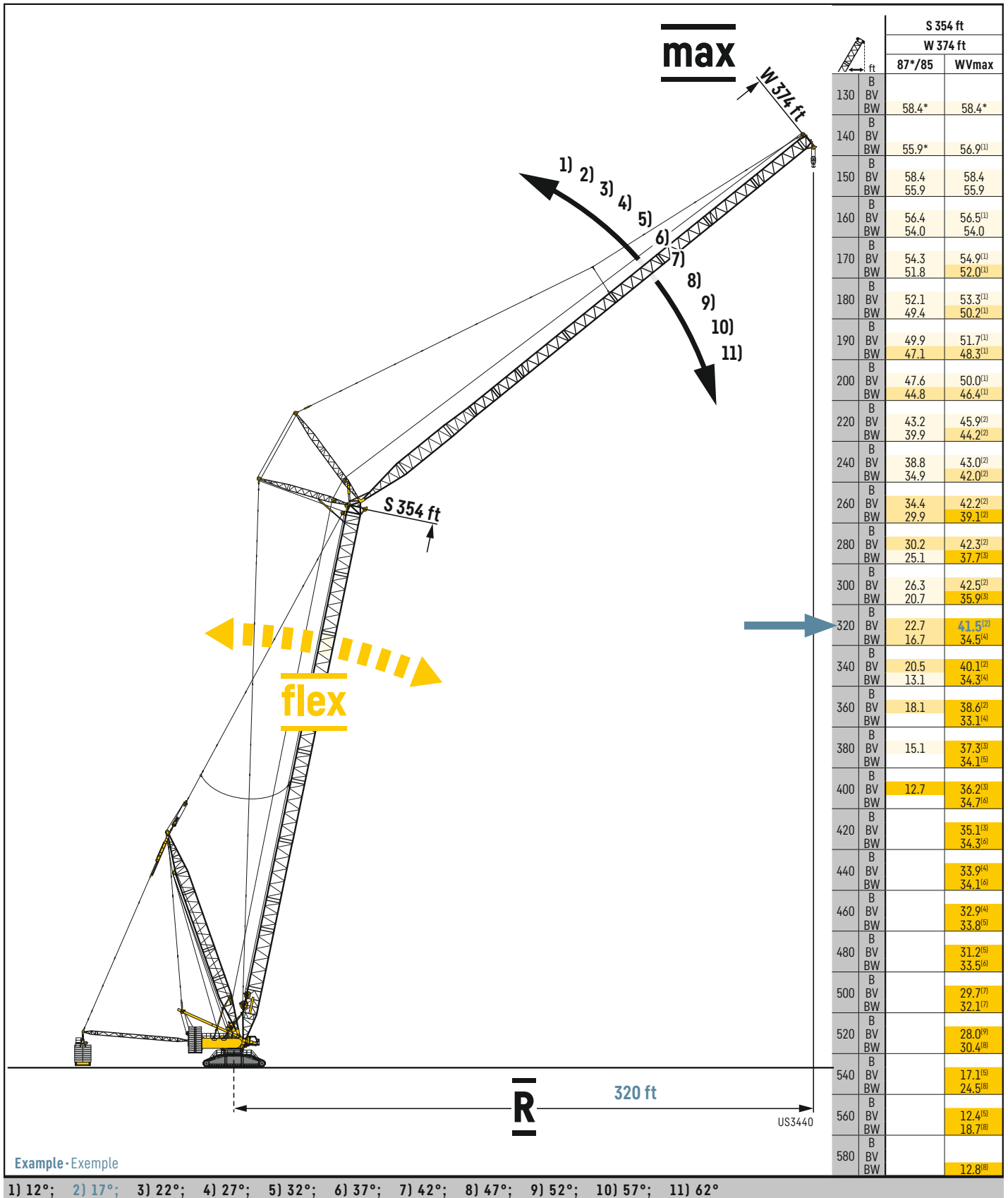

1) 12°; 2) 17°; 3) 22°; 4) 27°; 5) 32°; 6) 37°; 7) 42°; 8) 47°; 9) 52°; 10) 57°; 11) 62°

PDW3B/PDW3BW

P 158

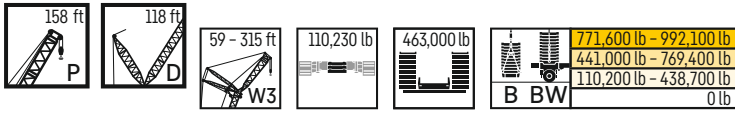

ft	B BW	P 158 ft													
		W3 59 ft		W3 79 ft		W3 98 ft		W3 118 ft		W3 138 ft		W3 158 ft		W3 177 ft	
		87°/85	WVmax	87°/85	WVmax	87°/85	WVmax	87°/85	WVmax	87°/85	WVmax	87°/85	WVmax	87°/85	WVmax
40	B	1432.0*	1433.0 ⁽¹⁾												
	BW	1432.0*	1433.0 ⁽¹⁾												
50	B	1429.0	1429.0	1343.0*	1381.0 ⁽¹⁾	1281.0*	1282.0 ⁽¹⁾								
	BW	1429.0	1431.0 ⁽¹⁾	1352.0*	1393.0 ⁽¹⁾	1293.0*	1296.0 ⁽¹⁾								
60	B	1129.0	1273.0 ⁽²⁾	1207.0	1263.0 ⁽¹⁾	1248.0	1248.0	1108.0*	1129.0 ⁽¹⁾	1002.0*	1004.0 ⁽¹⁾				
	BW	1131.0	1423.0 ⁽¹⁾	1214.0	1317.0 ⁽¹⁾	1282.0	1282.0	1120.0*	1141.0 ⁽¹⁾	1011.0*	1012.0 ⁽¹⁾				
70	B	870.0	1105.0 ⁽¹⁾	928.0	1114.0 ⁽¹⁾	1103.0	1109.0 ⁽²⁾	1079.0	1079.0	998.0	998.0	878.0*	890.0 ⁽¹⁾	795.0*	796.0 ⁽¹⁾
	BW	871.0	1340.0 ⁽¹⁾	927.0	1222.0 ⁽¹⁾	1170.0	1200.0 ⁽¹⁾	1120.0	1120.0	1012.0	1013.0 ⁽¹⁾	888.0*	900.0 ⁽¹⁾	804.0*	805.0 ⁽¹⁾
80	B	636.0	965.0 ⁽⁴⁾	743.0	965.0 ⁽¹⁾	973.0	977.0 ⁽³⁾	959.0	965.0 ⁽²⁾	942.0	942.0	879.0	879.0	798.0	798.0
	BW	637.0	1171.0 ⁽¹⁾	744.0	1128.0 ⁽¹⁾	1038.0	1122.0 ⁽¹⁾	1043.0	1079.0 ⁽¹⁾	978.0	978.0	892.0	894.0 ⁽¹⁾	808.0	808.0
90	B		838.0 ⁽⁴⁾	630.0	841.0 ⁽³⁾	865.0	866.0 ⁽⁴⁾	855.0	858.0 ⁽³⁾	844.0	848.0 ⁽²⁾	830.0	830.0	776.0	776.0
	BW		1043.0 ⁽¹⁾	632.0	1033.0 ⁽¹⁾	876.0	1036.0 ⁽²⁾	877.0	1023.0 ⁽¹⁾	873.0	939.0 ⁽¹⁾	845.0	879.0 ⁽¹⁾	790.0	790.0
100	B		735.0 ⁽³⁾	506.0	731.0 ⁽³⁾	748.0	772.0 ⁽⁶⁾	747.0	767.0 ⁽⁴⁾	746.0	760.0 ⁽³⁾	736.0	746.0 ⁽²⁾	724.0	724.0
	BW		937.0 ⁽²⁾	506.0	938.0 ⁽¹⁾	749.0	931.0 ⁽³⁾	749.0	922.0 ⁽²⁾	747.0	883.0 ⁽¹⁾	741.0	865.0 ⁽¹⁾	731.0	760.0 ⁽¹⁾
110	B		662.0 ⁽⁸⁾		650.0 ⁽²⁾	614.0	688.0 ⁽⁶⁾	649.0	682.0 ⁽⁵⁾	648.0	678.0 ⁽³⁾	643.0	669.0 ⁽³⁾	644.0	655.0 ⁽²⁾
	BW		838.0 ⁽²⁾		844.0 ⁽¹⁾	616.0	840.0 ⁽⁴⁾	649.0	832.0 ⁽²⁾	647.0	818.0 ⁽²⁾	644.0	817.0 ⁽¹⁾	644.0	747.0 ⁽¹⁾
120	B		592.0 ⁽⁸⁾		589.0 ⁽⁶⁾	453.0	623.0 ⁽⁷⁾	581.0	614.0 ⁽⁵⁾	568.0	606.0 ⁽⁴⁾	565.0	603.0 ⁽³⁾	566.0	594.0 ⁽³⁾
	BW		749.0 ⁽³⁾		749.0 ⁽¹⁾	453.0	757.0 ⁽⁴⁾	583.0	750.0 ⁽³⁾	569.0	748.0 ⁽²⁾	567.0	760.0 ⁽¹⁾	565.0	708.0 ⁽¹⁾
130	B		523.0 ⁽⁹⁾		532.0 ⁽⁶⁾		561.0 ⁽⁹⁾	510.0	559.0 ⁽⁷⁾	504.0	553.0 ⁽⁵⁾	502.0	544.0 ⁽⁴⁾	502.0	543.0 ⁽³⁾
	BW		668.0 ⁽⁵⁾		670.0 ⁽²⁾		693.0 ⁽⁴⁾	511.0	687.0 ⁽²⁾	507.0	680.0 ⁽¹⁾	501.0	703.0 ⁽¹⁾	502.0	669.0 ⁽¹⁾
140	B				479.0 ⁽⁸⁾		495.0 ⁽⁹⁾	383.0	520.0 ⁽⁸⁾	463.0	504.0 ⁽⁵⁾	450.0	498.0 ⁽⁴⁾	447.0	494.0 ⁽³⁾
	BW				609.0 ⁽⁴⁾		637.0 ⁽⁶⁾	384.0	632.0 ⁽⁴⁾	463.0	627.0 ⁽²⁾	450.0	646.0 ⁽¹⁾	450.0	630.0 ⁽¹⁾
150	B				430.0 ⁽⁹⁾		445.0 ⁽¹⁰⁾		468.0 ⁽⁹⁾	416.0	467.0 ⁽⁷⁾	413.0	455.0 ⁽⁵⁾	405.0	453.0 ⁽⁴⁾
	BW				538.0 ⁽⁷⁾		583.0 ⁽⁶⁾		581.0 ⁽⁴⁾	416.0	578.0 ⁽⁵⁾	414.0	589.0 ⁽¹⁾	405.0	591.0 ⁽¹⁾
160	B						402.0 ⁽¹⁰⁾		424.0 ⁽¹⁰⁾	325.0	430.0 ⁽⁸⁾	374.0	421.0 ⁽⁶⁾	366.0	419.0 ⁽⁵⁾
	BW						530.0 ⁽⁷⁾		531.0 ⁽⁵⁾	325.0	532.0 ⁽³⁾	375.0	532.0 ⁽¹⁾	368.0	552.0 ⁽¹⁾
170	B						359.0 ⁽¹⁰⁾		385.0 ⁽¹⁰⁾		392.0 ⁽¹⁰⁾	339.0	382.0 ⁽⁸⁾	341.0	384.0 ⁽⁵⁾
	BW						481.0 ⁽⁸⁾		486.0 ⁽⁵⁾		486.0 ⁽³⁾	339.0	484.0 ⁽²⁾	342.0	513.0 ⁽¹⁾
180	B						315.0 ⁽⁸⁾		349.0 ⁽¹⁰⁾		357.0 ⁽¹¹⁾	274.0	358.0 ⁽⁸⁾	312.0	353.0 ⁽⁶⁾
	BW						436.0 ⁽⁶⁾		447.0 ⁽⁶⁾		448.0 ⁽⁴⁾	274.0	440.0 ⁽²⁾	312.0	474.0 ⁽¹⁾
190	B						278.0 ⁽⁸⁾		314.0 ⁽¹⁰⁾		325.0 ⁽¹⁰⁾		330.0 ⁽⁹⁾	285.0	326.0 ⁽⁷⁾
	BW						391.0 ⁽⁸⁾		419.0 ⁽⁹⁾		411.0 ⁽⁴⁾		403.0 ⁽⁴⁾	285.0	435.0 ⁽¹⁾
200	B								276.0 ⁽⁸⁾		294.0 ⁽¹⁰⁾		309.0 ⁽¹⁰⁾	231.0	306.0 ⁽⁷⁾
	BW								382.0 ⁽⁸⁾		382.0 ⁽⁶⁾		376.0 ⁽⁴⁾	231.0	396.0 ⁽¹⁾
220	B										234.0 ⁽⁸⁾		258.0 ⁽¹⁰⁾		264.0 ⁽¹⁰⁾
	BW										328.0 ⁽⁸⁾		337.0 ⁽⁶⁾		332.0 ⁽⁴⁾
240	B												203.0 ⁽⁹⁾		226.0 ⁽¹¹⁾
	BW												291.0 ⁽⁸⁾		291.0 ⁽⁵⁾
260	B												153.0 ⁽⁷⁾		181.0 ⁽⁹⁾
	BW												231.0 ⁽⁷⁾		254.0 ⁽⁹⁾
280	B												120.0 ⁽⁷⁾		134.0 ⁽⁷⁾
	BW												188.0 ⁽⁷⁾		207.0 ⁽⁷⁾
300	B														108.0 ⁽⁷⁾
	BW														159.0 ⁽⁷⁾

1) 12° 2) 17° 3) 22° 4) 27° 5) 32° 6) 37° 7) 42° 8) 47° 9) 52° 10) 57° 11) 62°

PDW3B/PDW3BW

P 158

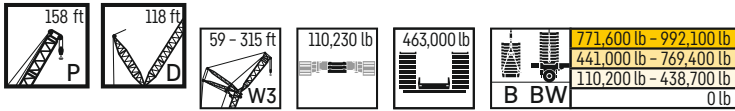

ft	B BW	P 158 ft													
		W3 197 ft		W3 217 ft		W3 236 ft		W3 256 ft		W3 276 ft		W3 295 ft		W3 315 ft	
		87°/85	WVmax	87°/85	WVmax	87°/85	WVmax	87°/85	WVmax	87°/85	WVmax	87°/85	WVmax	87°/85	WVmax
80	B	706.0*	712.0 ⁽¹⁾	641.0*	641.0*										
	BW	713.0*	720.0 ⁽¹⁾	648.0*	648.0*										
90	B	704.0	704.0	637.0	637.0	565.0*	570.0 ⁽¹⁾	513.0*	513.0*						
	BW	716.0	716.0	648.0	648.0	574.0*	578.0 ⁽¹⁾	518.0*	518.0*						
100	B	679.0	679.0	621.0	621.0	562.0	562.0	498.0*	498.0*	451.0*	451.0*	413.0*	413.0*		
	BW	692.0	692.0	633.0	633.0	572.0	572.0	505.0*	505.0*	458.0*	458.0*	418.0*	418.0*		
110	B	629.0	632.0 ⁽²⁾	599.0	599.0	548.0	548.0	497.0	497.0	440.0*	440.0*	403.0*	403.0*	364.0*	364.0*
	BW	632.0	656.0 ⁽¹⁾	609.0	609.0	558.0	558.0	504.0	504.0	446.0*	446.0*	408.0*	408.0*	369.0*	369.0*
120	B	560.0	580.0 ⁽²⁾	553.0	557.0 ⁽²⁾	525.0	526.0 ⁽²⁾	484.0	484.0	438.0	438.0	401.0	401.0	355.0*	355.0*
	BW	561.0	629.0 ⁽¹⁾	555.0	578.0 ⁽²⁾	533.0	536.0 ⁽²⁾	492.0	492.0	446.0	446.0	406.0	406.0	361.0*	361.0*
130	B	496.0	536.0 ⁽¹⁾	496.0	525.0 ⁽¹⁾	488.0	493.0 ⁽²⁾	462.0	464.0 ⁽²⁾	428.0	428.0	392.0	392.0	354.0	354.0
	BW	499.0	601.0 ⁽¹⁾	496.0	547.0 ⁽²⁾	490.0	510.0 ⁽²⁾	468.0	473.0 ⁽²⁾	435.0	435.0	398.0	398.0	360.0	360.0
140	B	446.0	496.0 ⁽¹⁾	444.0	496.0 ⁽¹⁾	440.0	461.0 ⁽²⁾	432.0	439.0 ⁽²⁾	411.0	411.0	381.0	381.0	346.0	346.0
	BW	447.0	574.0 ⁽¹⁾	444.0	515.0 ⁽²⁾	440.0	485.0 ⁽²⁾	433.0	451.0 ⁽²⁾	414.0	418.0 ⁽²⁾	388.0	388.0	352.0	352.0
150	B	401.0	456.0 ⁽¹⁾	399.0	467.0 ⁽¹⁾	397.0	428.0 ⁽²⁾	390.0	414.0 ⁽²⁾	386.0	389.0 ⁽²⁾	364.0	365.0 ⁽²⁾	338.0	338.0
	BW	401.0	546.0 ⁽¹⁾	399.0	486.0 ⁽²⁾	398.0	460.0 ⁽²⁾	390.0	429.0 ⁽²⁾	388.0	401.0 ⁽²⁾	368.0	373.0 ⁽²⁾	342.0	343.0 ⁽²⁾
160	B	363.0	415.0 ⁽¹⁾	361.0	439.0 ⁽¹⁾	359.0	396.0 ⁽³⁾	353.0	389.0 ⁽²⁾	350.0	368.0 ⁽²⁾	344.0	349.0 ⁽²⁾	328.0	328.0
	BW	363.0	519.0 ⁽¹⁾	362.0	457.0 ⁽²⁾	359.0	433.0 ⁽²⁾	353.0	409.0 ⁽²⁾	350.0	384.0 ⁽²⁾	343.0	358.0 ⁽²⁾	329.0	331.0 ⁽²⁾
170	B	331.0	379.0 ⁽⁴⁾	328.0	410.0 ⁽¹⁾	326.0	369.0 ⁽¹⁾	319.0	357.0 ⁽²⁾	318.0	346.0 ⁽²⁾	311.0	332.0 ⁽²⁾	309.0	309.0
	BW	332.0	491.0 ⁽¹⁾	329.0	428.0 ⁽²⁾	326.0	407.0 ⁽²⁾	321.0	386.0 ⁽²⁾	317.0	367.0 ⁽²⁾	310.0	343.0 ⁽²⁾	309.0	320.0 ⁽²⁾
180	B	309.0	347.0 ⁽⁵⁾	300.0	381.0 ⁽¹⁾	296.0	343.0 ⁽¹⁾	291.0	330.0 ⁽³⁾	289.0	320.0 ⁽³⁾	282.0	314.0 ⁽²⁾	280.0	295.0 ⁽²⁾
	BW	309.0	464.0 ⁽¹⁾	301.0	406.0 ⁽²⁾	297.0	381.0 ⁽²⁾	292.0	363.0 ⁽²⁾	288.0	347.0 ⁽²⁾	282.0	327.0 ⁽²⁾	281.0	308.0 ⁽²⁾
190	B	283.0	322.0 ⁽⁵⁾	280.0	352.0 ⁽¹⁾	272.0	317.0 ⁽¹⁾	266.0	304.0 ⁽³⁾	263.0	300.0 ⁽³⁾	257.0	289.0 ⁽²⁾	255.0	279.0 ⁽²⁾
	BW	283.0	436.0 ⁽¹⁾	280.0	385.0 ⁽²⁾	272.0	361.0 ⁽²⁾	267.0	340.0 ⁽²⁾	263.0	327.0 ⁽²⁾	257.0	309.0 ⁽²⁾	256.0	295.0 ⁽²⁾
200	B	260.0	298.0 ⁽⁵⁾	258.0	323.0 ⁽¹⁾	252.0	291.0 ⁽¹⁾	243.0	278.0 ⁽⁴⁾	241.0	278.0 ⁽³⁾	236.0	265.0 ⁽²⁾	233.0	259.0 ⁽²⁾
	BW	260.0	409.0 ⁽¹⁾	258.0	364.0 ⁽²⁾	252.0	343.0 ⁽²⁾	244.0	322.0 ⁽²⁾	241.0	307.0 ⁽²⁾	235.0	291.0 ⁽²⁾	233.0	278.0 ⁽²⁾
220	B	182.0	258.0 ⁽⁸⁾	220.0	265.0 ⁽¹⁾	218.0	248.0 ⁽⁵⁾	213.0	244.0 ⁽⁴⁾	203.0	236.0 ⁽⁴⁾	198.0	232.0 ⁽³⁾	194.0	223.0 ⁽³⁾
	BW	182.0	354.0 ⁽¹⁾	220.0	323.0 ⁽²⁾	218.0	307.0 ⁽²⁾	213.0	293.0 ⁽²⁾	203.0	279.0 ⁽²⁾	197.0	259.0 ⁽²⁾	194.0	245.0 ⁽²⁾
240	B		233.0 ⁽¹⁰⁾	151.0	226.0 ⁽⁸⁾	185.0	221.0 ⁽⁶⁾	182.0	217.0 ⁽⁵⁾	175.0	207.0 ⁽⁴⁾	167.0	201.0 ⁽³⁾	164.0	191.0 ⁽²⁾
	BW		299.0 ⁽¹⁾	151.0	280.0 ⁽²⁾	185.0	271.0 ⁽²⁾	181.0	263.0 ⁽²⁾	174.0	252.0 ⁽²⁾	168.0	234.0 ⁽²⁾	164.0	222.0 ⁽²⁾
260	B		192.0 ⁽¹¹⁾		198.0 ⁽⁹⁾		190.0 ⁽⁷⁾	155.0	188.0 ⁽⁵⁾	152.0	180.0 ⁽⁴⁾	143.0	174.0 ⁽³⁾	138.0	167.0 ⁽⁴⁾
	BW		246.0 ⁽⁵⁾		243.0 ⁽⁴⁾		237.0 ⁽³⁾	155.0	232.0 ⁽²⁾	152.0	225.0 ⁽²⁾	143.0	210.0 ⁽²⁾	137.0	200.0 ⁽²⁾
280	B		151.0 ⁽⁹⁾		165.0 ⁽¹¹⁾		169.0 ⁽¹⁰⁾		164.0 ⁽⁸⁾	130.0	159.0 ⁽⁶⁾	125.0	152.0 ⁽⁵⁾	122.0	146.0 ⁽⁴⁾
	BW		216.0 ⁽⁸⁾		211.0 ⁽⁷⁾		206.0 ⁽⁴⁾		201.0 ⁽³⁾	130.0	198.0 ⁽²⁾	125.0	185.0 ⁽²⁾	121.0	179.0 ⁽²⁾
300	B		117.0 ⁽⁷⁾		134.0 ⁽⁹⁾		144.0 ⁽¹¹⁾		144.0 ⁽⁹⁾		138.0 ⁽⁶⁾	104.0	132.0 ⁽⁵⁾	101.0	128.0 ⁽⁵⁾
	BW		181.0 ⁽⁷⁾		184.0 ⁽⁸⁾		179.0 ⁽⁷⁾		174.0 ⁽³⁾		171.0 ⁽²⁾	107.0	165.0 ⁽²⁾	101.0	159.0 ⁽²⁾
320	B				103.0 ⁽⁷⁾		116.0 ⁽⁹⁾		125.0 ⁽¹⁰⁾		121.0 ⁽⁹⁾		114.0 ⁽⁶⁾	85.1	111.0 ⁽⁵⁾
	BW				155.0 ⁽⁷⁾		158.0 ⁽⁸⁾		154.0 ⁽⁵⁾		149.0 ⁽³⁾		144.0 ⁽²⁾	84.7	141.0 ⁽²⁾
340	B						86.7 ⁽⁷⁾		102.0 ⁽⁹⁾		106.0 ⁽¹⁰⁾		101.0 ⁽⁸⁾		97.1 ⁽⁶⁾
	BW						135.0 ⁽⁷⁾		138.0 ⁽⁶⁾		133.0 ⁽⁴⁾		129.0 ⁽³⁾		124.0 ⁽²⁾
360	B								75.4 ⁽⁷⁾		86.1 ⁽⁹⁾		90.4 ⁽⁹⁾		84.9 ⁽⁷⁾
	BW								120.0 ⁽⁷⁾		121.0 ⁽⁶⁾		116.0 ⁽⁴⁾		110.0 ⁽³⁾
380	B										62.5 ⁽⁷⁾		73.9 ⁽⁹⁾		75.8 ⁽⁹⁾
	BW										105.0 ⁽⁷⁾		102.0 ⁽⁵⁾		95.1 ⁽³⁾
400	B												51.2 ⁽⁷⁾		60.0 ⁽⁹⁾
	BW												85.2 ⁽⁷⁾		81.7 ⁽⁵⁾
420	B														38.5 ⁽⁷⁾
	BW														70.4 ⁽⁷⁾

1) 12° 2) 17° 3) 22° 4) 27° 5) 32° 6) 37° 7) 42° 8) 47° 9) 52° 10) 57° 11) 62°

PDW3B/PDW3BW

P 177



ft	B BW	P 177 ft													
		W3 59 ft		W3 79 ft		W3 98 ft		W3 118 ft		W3 138 ft		W3 158 ft		W3 177 ft	
		87*/85	WVmax	87*/85	WVmax	87*/85	WVmax	87*/85	WVmax	87*/85	WVmax	87*/85	WVmax	87*/85	WVmax
40	B	1432.0*	1432.0*												
40	BW	1432.0*	1432.0*												
50	B	1430.0	1430.0	1323.0*	1323.0*	1244.0*	1244.0*								
50	BW	1432.0	1432.0	1335.0*	1335.0*	1257.0*	1257.0*								
60	B	1189.0	1276.0 ⁽²⁾	1245.0	1245.0	1213.0	1213.0	1076.0*	1092.0 ⁽¹⁾	973.0*	973.0*				
60	BW	1195.0	1380.0 ⁽¹⁾	1305.0	1305.0	1255.0	1255.0	1089.0*	1107.0 ⁽¹⁾	983.0*	983.0*				
70	B	906.0	1099.0 ⁽²⁾	996.0	1117.0 ⁽¹⁾	1088.0	1092.0 ⁽²⁾	1060.0	1060.0	976.0	976.0	854.0*	865.0 ⁽¹⁾	776.0*	776.0*
70	BW	907.0	1321.0 ⁽¹⁾	997.0	1205.0 ⁽²⁾	1170.0	1185.0 ⁽¹⁾	1094.0	1094.0	987.0	987.0	864.0*	875.0 ⁽¹⁾	783.0*	783.0*
80	B	670.0	957.0 ⁽²⁾	796.0	1020.0 ⁽¹⁾	960.0	964.0 ⁽²⁾	946.0	949.0 ⁽²⁾	926.0	926.0	859.0	859.0	779.0	779.0
80	BW	671.0	1166.0 ⁽²⁾	798.0	1110.0 ⁽²⁾	1052.0	1114.0 ⁽¹⁾	1058.0	1058.0	962.0	962.0	872.0	872.0	788.0	788.0
90	B		848.0 ⁽⁵⁾	671.0	922.0 ⁽¹⁾	855.0	858.0 ⁽⁴⁾	844.0	848.0 ⁽³⁾	833.0	838.0 ⁽²⁾	818.0	818.0	758.0	758.0
90	BW		1026.0 ⁽²⁾	674.0	1010.0 ⁽²⁾	902.0	1018.0 ⁽¹⁾	911.0	1000.0 ⁽¹⁾	900.0	918.0 ⁽¹⁾	846.0	859.0 ⁽¹⁾	773.0	773.0
100	B		748.0 ⁽⁵⁾	525.0	825.0 ⁽¹⁾	768.0	769.0 ⁽⁴⁾	758.0	761.0 ⁽⁴⁾	752.0	754.0 ⁽³⁾	740.0	742.0 ⁽²⁾	722.0	722.0
100	BW		927.0 ⁽¹⁾	526.0	924.0 ⁽¹⁾	771.0	919.0 ⁽²⁾	773.0	909.0 ⁽¹⁾	770.0	876.0 ⁽¹⁾	773.0	845.0 ⁽¹⁾	737.0	743.0 ⁽²⁾
110	B		669.0 ⁽⁷⁾		727.0 ⁽¹⁾	648.0	693.0 ⁽⁷⁾	668.0	686.0 ⁽⁵⁾	672.0	684.0 ⁽⁴⁾	665.0	674.0 ⁽³⁾	659.0	659.0
110	BW		837.0 ⁽²⁾		842.0 ⁽¹⁾	647.0	833.0 ⁽⁴⁾	668.0	824.0 ⁽²⁾	667.0	815.0 ⁽²⁾	668.0	817.0 ⁽¹⁾	669.0	710.0 ⁽²⁾
120	B		603.0 ⁽⁸⁾		629.0 ⁽¹⁾	491.0	621.0 ⁽⁷⁾	597.0	616.0 ⁽³⁾	589.0	617.0 ⁽⁴⁾	583.0	609.0 ⁽³⁾	586.0	608.0 ⁽¹⁾
120	BW		755.0 ⁽⁴⁾		760.0 ⁽¹⁾	489.0	755.0 ⁽⁵⁾	601.0	750.0 ⁽³⁾	586.0	744.0 ⁽²⁾	584.0	772.0 ⁽¹⁾	586.0	678.0 ⁽²⁾
130	B		536.0 ⁽⁸⁾		549.0 ⁽⁸⁾		565.0 ⁽⁹⁾	530.0	559.0 ⁽⁶⁾	523.0	559.0 ⁽⁵⁾	517.0	552.0 ⁽⁴⁾	519.0	563.0 ⁽¹⁾
130	BW		679.0 ⁽⁴⁾		687.0 ⁽³⁾		685.0 ⁽⁵⁾	528.0	679.0 ⁽⁴⁾	520.0	674.0 ⁽²⁾	518.0	727.0 ⁽¹⁾	521.0	643.0 ⁽²⁾
140	B		472.0 ⁽⁹⁾		499.0 ⁽⁹⁾		511.0 ⁽⁹⁾	415.0	513.0 ⁽⁸⁾	477.0	510.0 ⁽⁶⁾	464.0	503.0 ⁽⁴⁾	464.0	519.0 ⁽¹⁾
140	BW		614.0 ⁽⁶⁾		621.0 ⁽³⁾		630.0 ⁽⁵⁾	416.0	624.0 ⁽³⁾	475.0	620.0 ⁽¹⁾	464.0	682.0 ⁽¹⁾	465.0	601.0 ⁽²⁾
150	B				445.0 ⁽⁷⁾		460.0 ⁽¹⁰⁾		474.0 ⁽⁹⁾	429.0	470.0 ⁽⁷⁾	426.0	465.0 ⁽⁵⁾	418.0	474.0 ⁽¹⁾
150	BW				563.0 ⁽⁴⁾		584.0 ⁽⁸⁾		577.0 ⁽⁴⁾	426.0	573.0 ⁽²⁾	427.0	637.0 ⁽¹⁾	419.0	563.0 ⁽¹⁾
160	B				395.0 ⁽⁷⁾		419.0 ⁽¹⁰⁾		432.0 ⁽¹⁰⁾	356.0	439.0 ⁽⁸⁾	384.0	432.0 ⁽⁶⁾	379.0	430.0 ⁽¹⁾
160	BW				523.0 ⁽⁷⁾		539.0 ⁽⁸⁾		536.0 ⁽⁶⁾	355.0	533.0 ⁽⁴⁾	387.0	592.0 ⁽¹⁾	380.0	530.0 ⁽¹⁾
170	B						379.0 ⁽¹⁰⁾		391.0 ⁽⁹⁾		406.0 ⁽¹⁰⁾	350.0	397.0 ⁽⁷⁾	350.0	396.0 ⁽⁵⁾
170	BW						495.0 ⁽⁸⁾		497.0 ⁽⁶⁾		495.0 ⁽⁴⁾	349.0	547.0 ⁽¹⁾	350.0	497.0 ⁽¹⁾
180	B						339.0 ⁽¹⁰⁾		354.0 ⁽⁹⁾		372.0 ⁽¹⁰⁾	295.0	373.0 ⁽⁸⁾	322.0	366.0 ⁽⁴⁾
180	BW						451.0 ⁽⁹⁾		458.0 ⁽⁶⁾		457.0 ⁽⁴⁾	295.0	501.0 ⁽¹⁾	322.0	464.0 ⁽¹⁾
190	B						299.0 ⁽⁸⁾		317.0 ⁽⁹⁾		343.0 ⁽¹¹⁾		343.0 ⁽⁸⁾	294.0	338.0 ⁽⁴⁾
190	BW						411.0 ⁽⁸⁾		423.0 ⁽⁸⁾		423.0 ⁽⁵⁾		456.0 ⁽¹⁾	294.0	431.0 ⁽¹⁾
200	B						266.0 ⁽⁸⁾		282.0 ⁽¹⁰⁾		309.0 ⁽¹⁰⁾		315.0 ⁽⁹⁾	247.0	313.0 ⁽⁸⁾
200	BW						373.0 ⁽⁸⁾		392.0 ⁽⁹⁾		391.0 ⁽⁶⁾		411.0 ⁽¹⁾	248.0	398.0 ⁽¹⁾
220	B								227.0 ⁽⁸⁾		249.0 ⁽¹⁰⁾		266.0 ⁽⁹⁾		271.0 ⁽⁹⁾
220	BW								327.0 ⁽⁸⁾		344.0 ⁽⁹⁾		338.0 ⁽⁵⁾		337.0 ⁽⁴⁾
240	B										195.0 ⁽⁶⁾		220.0 ⁽¹⁰⁾		232.0 ⁽¹¹⁾
240	BW										283.0 ⁽⁸⁾		302.0 ⁽⁹⁾		296.0 ⁽⁴⁾
260	B												169.0 ⁽⁹⁾		185.0 ⁽⁷⁾
260	BW												251.0 ⁽⁸⁾		271.0 ⁽⁹⁾
280	B												129.0 ⁽⁷⁾		147.0 ⁽⁹⁾
280	BW												198.0 ⁽⁷⁾		226.0 ⁽⁹⁾
300	B														114.0 ⁽⁷⁾
300	BW														177.0 ⁽⁷⁾

1) 12° 2) 17° 3) 22° 4) 27° 5) 32° 6) 37° 7) 42° 8) 47° 9) 52° 10) 57° 11) 62°

PDW3B/PDW3BW

P 177

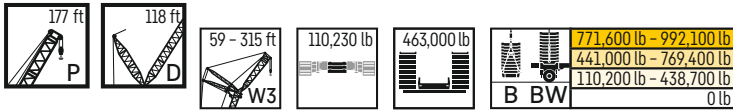

ft		P 177 ft													
		W3 197 ft		W3 217 ft		W3 236 ft		W3 256 ft		W3 276 ft		W3 295 ft		W3 315 ft	
		87°/85	WVmax	87°/85	WVmax	87°/85	WVmax	87°/85	WVmax	87°/85	WVmax	87°/85	WVmax	87°/85	WVmax
80	B	688.0*	691.0 ⁽¹⁾	623.0*	623.0*										
	BW	693.0*	699.0 ⁽¹⁾	630.0*	630.0*										
90	B	687.0	687.0	606.0*	617.0 ⁽¹⁾	550.0*	554.0 ⁽¹⁾	498.0*	498.0*						
	BW	698.0	698.0	617.0*	627.0 ⁽¹⁾	558.0*	561.0 ⁽¹⁾	505.0*	505.0*						
100	B	668.0	668.0	605.0	605.0	548.0	548.0	487.0*	487.0*	440.0*	440.0*	401.0*	401.0*		
	BW	678.0	678.0	618.0	618.0	557.0	557.0	492.0*	492.0*	445.0*	445.0*	406.0*	406.0*		
110	B	638.0	638.0	587.0	587.0	534.0	534.0	486.0	486.0	428.0*	428.0*	394.0*	394.0*	354.0*	354.0*
	BW	641.0	651.0 ⁽²⁾	599.0	599.0	544.0	544.0	492.0	492.0	435.0*	435.0*	397.0*	397.0*	359.0*	359.0*
120	B	582.0	590.0 ⁽¹⁾	558.0	558.0	520.0	520.0	476.0	476.0	429.0	429.0	393.0	393.0	346.0*	346.0*
	BW	579.0	622.0 ⁽²⁾	564.0	575.0 ⁽²⁾	529.0	529.0	481.0	481.0	436.0	436.0	396.0	396.0	350.0*	350.0*
130	B	516.0	558.0 ⁽¹⁾	511.0	519.0 ⁽¹⁾	496.0	496.0	463.0	463.0	419.0	419.0	384.0	384.0	345.0	345.0
	BW	513.0	594.0 ⁽²⁾	511.0	552.0 ⁽²⁾	499.0	508.0 ⁽²⁾	465.0	466.0 ⁽²⁾	426.0	426.0	389.0	389.0	351.0	351.0
140	B	461.0	526.0 ⁽¹⁾	457.0	493.0 ⁽¹⁾	453.0	464.0 ⁽²⁾	444.0	444.0	409.0	409.0	376.0	376.0	338.0	338.0
	BW	458.0	567.0 ⁽¹⁾	456.0	528.0 ⁽²⁾	454.0	489.0 ⁽²⁾	440.0	451.0 ⁽²⁾	415.0	415.0	380.0	380.0	344.0	344.0
150	B	415.0	494.0 ⁽¹⁾	409.0	466.0 ⁽¹⁾	408.0	436.0 ⁽²⁾	405.0	414.0 ⁽²⁾	394.0	394.0	369.0	369.0	332.0	332.0
	BW	411.0	542.0 ⁽¹⁾	410.0	502.0 ⁽²⁾	407.0	470.0 ⁽²⁾	402.0	435.0 ⁽²⁾	396.0	401.0 ⁽²⁾	370.0	370.0	337.0	337.0
160	B	376.0	463.0 ⁽¹⁾	371.0	439.0 ⁽¹⁾	368.0	404.0 ⁽³⁾	367.0	391.0 ⁽²⁾	358.0	374.0 ⁽²⁾	356.0	356.0	325.0	325.0
	BW	373.0	516.0 ⁽¹⁾	372.0	474.0 ⁽²⁾	368.0	447.0 ⁽²⁾	364.0	419.0 ⁽²⁾	360.0	388.0 ⁽²⁾	354.0	358.0 ⁽²⁾	330.0	330.0
170	B	342.0	431.0 ⁽¹⁾	337.0	412.0 ⁽¹⁾	334.0	377.0 ⁽³⁾	333.0	366.0 ⁽³⁾	326.0	358.0 ⁽²⁾	324.0	338.0 ⁽²⁾	312.0	312.0
	BW	340.0	491.0 ⁽¹⁾	338.0	446.0 ⁽²⁾	334.0	422.0 ⁽²⁾	330.0	398.0 ⁽²⁾	325.0	374.0 ⁽²⁾	320.0	347.0 ⁽²⁾	317.0	320.0 ⁽²⁾
180	B	319.0	399.0 ⁽¹⁾	307.0	385.0 ⁽¹⁾	304.0	347.0 ⁽³⁾	303.0	343.0 ⁽³⁾	297.0	332.0 ⁽²⁾	295.0	325.0 ⁽²⁾	285.0	299.0 ⁽²⁾
	BW	318.0	465.0 ⁽¹⁾	307.0	420.0 ⁽²⁾	305.0	397.0 ⁽²⁾	300.0	376.0 ⁽²⁾	297.0	357.0 ⁽²⁾	290.0	336.0 ⁽²⁾	289.0	312.0 ⁽²⁾
190	B	292.0	367.0 ⁽¹⁾	285.0	358.0 ⁽¹⁾	278.0	320.0 ⁽⁴⁾	277.0	317.0 ⁽³⁾	270.0	309.0 ⁽³⁾	270.0	301.0 ⁽²⁾	262.0	288.0 ⁽²⁾
	BW	290.0	440.0 ⁽¹⁾	286.0	396.0 ⁽²⁾	279.0	374.0 ⁽²⁾	274.0	355.0 ⁽²⁾	270.0	338.0 ⁽²⁾	264.0	318.0 ⁽²⁾	262.0	303.0 ⁽²⁾
200	B	268.0	336.0 ⁽¹⁾	265.0	331.0 ⁽¹⁾	257.0	296.0 ⁽⁴⁾	254.0	291.0 ⁽⁴⁾	246.0	288.0 ⁽³⁾	246.0	277.0 ⁽³⁾	239.0	269.0 ⁽²⁾
	BW	266.0	414.0 ⁽¹⁾	265.0	373.0 ⁽²⁾	257.0	355.0 ⁽²⁾	250.0	335.0 ⁽²⁾	247.0	319.0 ⁽²⁾	242.0	301.0 ⁽²⁾	239.0	287.0 ⁽²⁾
220	B	198.0	272.0 ⁽¹⁾	224.0	278.0 ⁽¹⁾	223.0	256.0 ⁽⁵⁾	219.0	253.0 ⁽⁴⁾	209.0	245.0 ⁽³⁾	205.0	241.0 ⁽³⁾	199.0	231.0 ⁽³⁾
	BW	197.0	363.0 ⁽¹⁾	225.0	326.0 ⁽²⁾	223.0	318.0 ⁽²⁾	217.0	304.0 ⁽²⁾	209.0	288.0 ⁽²⁾	203.0	267.0 ⁽²⁾	199.0	256.0 ⁽²⁾
240	B		239.0 ⁽⁹⁾	166.0	234.0 ⁽⁷⁾	189.0	227.0 ⁽⁶⁾	189.0	224.0 ⁽⁵⁾	178.0	214.0 ⁽⁴⁾	175.0	207.0 ⁽³⁾	169.0	198.0 ⁽³⁾
	BW		312.0 ⁽¹⁾	166.0	287.0 ⁽³⁾	188.0	281.0 ⁽²⁾	186.0	274.0 ⁽²⁾	178.0	262.0 ⁽²⁾	172.0	244.0 ⁽²⁾	169.0	231.0 ⁽²⁾
260	B		206.0 ⁽¹¹⁾		208.0 ⁽⁹⁾	137.0	205.0 ⁽⁷⁾	161.0	196.0 ⁽⁵⁾	156.0	186.0 ⁽⁴⁾	149.0	180.0 ⁽³⁾	142.0	174.0 ⁽⁴⁾
	BW		260.0 ⁽¹⁾		257.0 ⁽⁴⁾	137.0	250.0 ⁽³⁾	158.0	243.0 ⁽²⁾	156.0	235.0 ⁽²⁾	146.0	221.0 ⁽²⁾	142.0	210.0 ⁽²⁾
280	B		164.0 ⁽¹¹⁾		174.0 ⁽⁹⁾		175.0 ⁽⁸⁾	116.0	170.0 ⁽⁸⁾	132.0	164.0 ⁽⁶⁾	131.0	159.0 ⁽⁵⁾	124.0	152.0 ⁽⁴⁾
	BW		228.0 ⁽⁹⁾		222.0 ⁽⁵⁾		218.0 ⁽⁴⁾	115.0	213.0 ⁽³⁾	132.0	208.0 ⁽²⁾	128.0	197.0 ⁽²⁾	124.0	189.0 ⁽²⁾
300	B		130.0 ⁽⁹⁾		144.0 ⁽¹¹⁾		152.0 ⁽¹¹⁾		152.0 ⁽⁹⁾	91.5	143.0 ⁽⁶⁾	112.0	138.0 ⁽⁶⁾	104.0	133.0 ⁽⁵⁾
	BW		189.0 ⁽⁹⁾		189.0 ⁽⁸⁾		189.0 ⁽⁵⁾		185.0 ⁽³⁾	91.3	181.0 ⁽²⁾	109.0	175.0 ⁽²⁾	104.0	168.0 ⁽²⁾
320	B		98.7 ⁽⁷⁾		112.0 ⁽⁹⁾		128.0 ⁽¹¹⁾		131.0 ⁽⁹⁾		126.0 ⁽⁹⁾	74.2	121.0 ⁽⁸⁾	87.3	114.0 ⁽⁵⁾
	BW		151.0 ⁽⁷⁾		166.0 ⁽⁹⁾		167.0 ⁽⁸⁾		161.0 ⁽⁴⁾		157.0 ⁽³⁾	72.6	152.0 ⁽²⁾	87.8	149.0 ⁽²⁾
340	B				85.1 ⁽⁷⁾		97.6 ⁽⁹⁾		113.0 ⁽¹¹⁾		109.0 ⁽¹⁰⁾		106.0 ⁽⁹⁾	55.5	97.6 ⁽⁷⁾
	BW				135.0 ⁽⁷⁾		145.0 ⁽⁹⁾		143.0 ⁽⁷⁾		138.0 ⁽⁶⁾		134.0 ⁽⁵⁾	55.6	130.0 ⁽²⁾
360	B						72.2 ⁽⁷⁾		85.4 ⁽⁹⁾		93.6 ⁽¹¹⁾		90.7 ⁽⁹⁾		83.7 ⁽⁸⁾
	BW						117.0 ⁽⁷⁾		128.0 ⁽⁸⁾		123.0 ⁽⁵⁾		118.0 ⁽⁴⁾		111.0 ⁽³⁾
380	B								60.1 ⁽⁷⁾		70.4 ⁽⁹⁾		77.2 ⁽¹¹⁾		71.0 ⁽¹⁰⁾
	BW								104.0 ⁽⁷⁾		111.0 ⁽⁷⁾		104.0 ⁽⁴⁾		98.3 ⁽⁴⁾
400	B										48.2 ⁽⁷⁾		55.6 ⁽⁹⁾		60.4 ⁽¹¹⁾
	BW										90.0 ⁽⁷⁾		93.3 ⁽⁷⁾		87.9 ⁽⁵⁾
420	B												35.3 ⁽⁷⁾		39.8 ⁽⁹⁾
	BW												75.4 ⁽⁷⁾		77.7 ⁽⁷⁾
440	B														20.5 ⁽⁷⁾
	BW														61.8 ⁽⁷⁾

1) 12° 2) 17° 3) 22° 4) 27° 5) 32° 6) 37° 7) 42° 8) 47° 9) 52° 10) 57° 11) 62°

PDW3B/PDW3BW

P 197

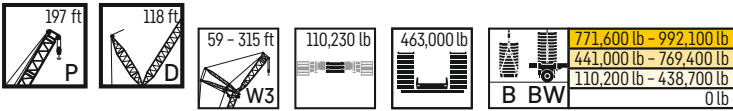

		P 197 ft													
		W3 59 ft		W3 79 ft		W3 98 ft		W3 118 ft		W3 138 ft		W3 158 ft		W3 177 ft	
		87°/85	WVmax	87°/85	WVmax	87°/85	WVmax	87°/85	WVmax	87°/85	WVmax	87°/85	WVmax	87°/85	WVmax
50	B	1400.0	1400.0	1290.0*	1290.0*	1198.0*	1198.0*								
	BW	1432.0	1433.0 ⁽¹⁾	1302.0*	1302.0*	1220.0*	1220.0*								
60	B	1237.0	1250.0 ⁽²⁾	1213.0	1213.0	1177.0	1177.0	1045.0*	1057.0 ⁽¹⁾	947.0*	947.0*				
	BW	1261.0	1368.0 ⁽²⁾	1298.0	1298.0	1228.0	1228.0	1057.0*	1068.0 ⁽¹⁾	957.0*	957.0*				
70	B	944.0	1095.0 ⁽³⁾	1044.0	1107.0 ⁽¹⁾	1067.0	1068.0 ⁽²⁾	1031.0	1031.0	916.0*	945.0 ⁽¹⁾	831.0*	840.0 ⁽¹⁾	754.0*	754.0*
	BW	948.0	1283.0 ⁽¹⁾	1044.0	1202.0 ⁽²⁾	1163.0	1164.0 ⁽²⁾	1067.0	1067.0	929.0*	957.0 ⁽¹⁾	840.0*	849.0 ⁽¹⁾	763.0*	763.0*
80	B	723.0	946.0 ⁽¹⁾	829.0	1019.0 ⁽¹⁾	948.0*	951.0 ⁽²⁾	932.0	934.0 ⁽²⁾	910.0	910.0	840.0	840.0	736.0*	752.0 ⁽¹⁾
	BW	723.0	1157.0 ⁽²⁾	830.0	1111.0 ⁽²⁾	1051.0	1089.0 ⁽¹⁾	1029.0	1029.0	942.0	942.0	851.0	851.0	745.0*	762.0 ⁽¹⁾
90	B		839.0 ⁽⁴⁾	690.0	930.0 ⁽¹⁾	845.0	848.0 ⁽⁴⁾	835.0*	836.0 ⁽⁵⁾	821.0	825.0 ⁽²⁾	801.0	801.0	741.0	741.0
	BW		1026.0 ⁽²⁾	691.0	1014.0 ⁽²⁾	929.0	1008.0 ⁽¹⁾	956.0	968.0 ⁽¹⁾	903.0	906.0 ⁽¹⁾	830.0	833.0 ⁽¹⁾	756.0	756.0
100	B		750.0 ⁽⁶⁾	561.0	842.0 ⁽¹⁾	760.0	761.0 ⁽⁶⁾	751.0	753.0 ⁽⁵⁾	743.0	745.0 ⁽³⁾	730.0	732.0 ⁽²⁾	710.0	710.0
	BW		906.0 ⁽³⁾	562.0	909.0 ⁽²⁾	792.0	909.0 ⁽²⁾	829.0	898.0 ⁽¹⁾	826.0	876.0 ⁽⁴⁾	796.0	815.0 ⁽¹⁾	733.0	733.0
110	B		667.0 ⁽⁷⁾		753.0 ⁽¹⁾	655.0	688.0 ⁽⁷⁾	681.0	682.0 ⁽⁵⁾	675.0	676.0 ⁽⁴⁾	665.0	666.0 ⁽³⁾	656.0	656.0
	BW		795.0 ⁽⁶⁾		810.0 ⁽²⁾	656.0	824.0 ⁽⁴⁾	718.0	815.0 ⁽²⁾	715.0	807.0 ⁽¹⁾	709.0	794.0 ⁽¹⁾	698.0	708.0 ⁽²⁾
120	B		585.0 ⁽¹¹⁾		665.0 ⁽¹⁾	502.0	618.0 ⁽⁷⁾	624.0	624.0	616.0	617.0 ⁽⁵⁾	607.0	608.0 ⁽⁴⁾	602.0	606.0 ⁽¹⁾
	BW		587.0 ⁽¹¹⁾		745.0 ⁽²⁾	502.0	752.0 ⁽⁵⁾	640.0	744.0 ⁽³⁾	628.0	737.0 ⁽²⁾	623.0	744.0 ⁽¹⁾	623.0	685.0 ⁽²⁾
130	B				576.0 ⁽¹⁾		558.0 ⁽⁸⁾	545.0	571.0 ⁽⁸⁾	555.0	564.0 ⁽⁶⁾	554.0	558.0 ⁽⁵⁾	550.0	565.0 ⁽¹⁾
	BW				683.0 ⁽⁵⁾		688.0 ⁽⁴⁾	547.0	685.0 ⁽⁵⁾	556.0	677.0 ⁽³⁾	553.0	695.0 ⁽¹⁾	553.0	661.0 ⁽²⁾
140	B				501.0 ⁽¹⁰⁾		510.0 ⁽⁹⁾	426.0	518.0 ⁽⁸⁾	502.0	514.0 ⁽⁶⁾	493.0	511.0 ⁽⁵⁾	492.0	523.0 ⁽¹⁾
	BW				623.0 ⁽⁴⁾		624.0 ⁽⁶⁾	426.0	628.0 ⁽⁵⁾	505.0	624.0 ⁽⁴⁾	494.0	645.0 ⁽¹⁾	493.0	612.0 ⁽²⁾
150	B				456.0 ⁽¹⁰⁾		463.0 ⁽⁹⁾		472.0 ⁽⁹⁾	452.0	470.0 ⁽⁷⁾	453.0	464.0 ⁽⁵⁾	444.0	482.0 ⁽¹⁾
	BW				567.0 ⁽⁴⁾		575.0 ⁽⁵⁾		575.0 ⁽⁶⁾	452.0	573.0 ⁽⁴⁾	453.0	596.0 ⁽¹⁾	444.0	563.0 ⁽¹⁾
160	B				411.0 ⁽¹⁰⁾		422.0 ⁽¹⁰⁾		435.0 ⁽¹⁰⁾	362.0	435.0 ⁽⁸⁾	408.0	428.0 ⁽⁶⁾	403.0	440.0 ⁽¹⁾
	BW				516.0 ⁽⁵⁾		534.0 ⁽⁸⁾		529.0 ⁽⁷⁾	362.0	526.0 ⁽⁵⁾	409.0	547.0 ⁽¹⁾	402.0	533.0 ⁽¹⁾
170	B				367.0 ⁽¹⁰⁾		388.0 ⁽¹⁰⁾		396.0 ⁽¹⁰⁾		404.0 ⁽⁹⁾	359.0	397.0 ⁽⁷⁾	370.0	399.0 ⁽¹⁾
	BW				478.0 ⁽⁸⁾		492.0 ⁽⁸⁾		495.0 ⁽⁸⁾		490.0 ⁽⁵⁾	360.0	497.0 ⁽¹⁾	372.0	502.0 ⁽¹⁾
180	B						353.0 ⁽¹⁰⁾		361.0 ⁽¹⁰⁾		375.0 ⁽¹⁰⁾	298.0	371.0 ⁽⁸⁾	340.0	367.0 ⁽⁶⁾
	BW						451.0 ⁽⁸⁾		460.0 ⁽⁸⁾		460.0 ⁽⁷⁾	298.0	451.0 ⁽⁴⁾	340.0	471.0 ⁽¹⁾
190	B						318.0 ⁽¹⁰⁾		330.0 ⁽¹⁰⁾		343.0 ⁽¹⁰⁾		346.0 ⁽⁹⁾	300.0	343.0 ⁽⁷⁾
	BW						412.0 ⁽⁹⁾		426.0 ⁽⁹⁾		431.0 ⁽⁸⁾		422.0 ⁽⁵⁾	300.0	441.0 ⁽¹⁾
200	B								298.0 ⁽¹⁰⁾		314.0 ⁽¹⁰⁾		320.0 ⁽¹⁰⁾	251.0	323.0 ⁽⁸⁾
	BW								393.0 ⁽⁹⁾		402.0 ⁽⁸⁾		394.0 ⁽⁵⁾	251.0	410.0 ⁽¹⁾
220	B								235.0 ⁽⁷⁾		262.0 ⁽¹⁰⁾		272.0 ⁽¹⁰⁾		279.0 ⁽⁹⁾
	BW								329.0 ⁽⁸⁾		345.0 ⁽⁹⁾		341.0 ⁽⁶⁾		349.0 ⁽¹⁾
240	B								191.0 ⁽⁷⁾		207.0 ⁽⁸⁾		229.0 ⁽¹⁰⁾		240.0 ⁽¹¹⁾
	BW								272.0 ⁽⁸⁾		292.0 ⁽⁸⁾		297.0 ⁽⁸⁾		297.0 ⁽⁶⁾
260	B										159.0 ⁽⁸⁾		183.0 ⁽⁹⁾		196.0 ⁽¹¹⁾
	BW										244.0 ⁽⁸⁾		256.0 ⁽⁸⁾		263.0 ⁽⁸⁾
280	B												139.0 ⁽⁹⁾		155.0 ⁽⁹⁾
	BW												217.0 ⁽⁸⁾		227.0 ⁽⁹⁾
300	B												107.0 ⁽⁷⁾		124.0 ⁽⁹⁾
	BW												168.0 ⁽⁷⁾		184.0 ⁽⁹⁾

1) 12° 2) 17° 3) 22° 4) 27° 5) 32° 6) 37° 7) 42° 8) 47° 9) 52° 10) 57° 11) 62°

PDW3B/PDW3BW

P 197

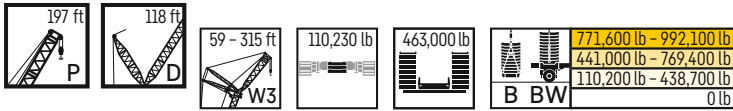

ft	B BW	P 197 ft													
		W3 197 ft		W3 217 ft		W3 236 ft		W3 256 ft		W3 276 ft		W3 295 ft		W3 315 ft	
		87°/85	WVmax	87°/85	WVmax	87°/85	WVmax	87°/85	WVmax	87°/85	WVmax	87°/85	WVmax	87°/85	WVmax
80	B	669.0*	673.0 ⁽¹⁾	607.0*	607.0*										
	BW	676.0*	681.0 ⁽¹⁾	613.0*	613.0*										
90	B	670.0	670.0	589.0*	599.0 ⁽¹⁾	535.0*	539.0 ⁽¹⁾	487.0*	487.0*						
	BW	683.0	683.0	600.0*	609.0 ⁽¹⁾	544.0*	546.0 ⁽¹⁾	494.0*	494.0*						
100	B	651.0	651.0	591.0	591.0	534.0	534.0	474.0*	474.0*	429.0*	429.0*	393.0*	393.0*		
	BW	664.0	664.0	602.0	602.0	544.0	544.0	481.0*	481.0*	434.0*	434.0*	381.0*	381.0*		
110	B	627.0	627.0	575.0	575.0	523.0	523.0	475.0	475.0	417.0*	417.0*	383.0*	383.0*	345.0*	345.0*
	BW	646.0	646.0	586.0	586.0	532.0	532.0	483.0	483.0	424.0*	424.0*	389.0*	389.0*	350.0*	350.0*
120	B	592.0	592.0	561.0	561.0	509.0	509.0	464.0	464.0	418.0	418.0	374.0*	374.0*	337.0*	337.0*
	BW	613.0	631.0 ⁽²⁾	572.0	573.0 ⁽²⁾	520.0	520.0	473.0	473.0	426.0	426.0	379.0*	379.0*	342.0*	342.0*
130	B	542.0	545.0 ⁽³⁾	531.0	531.0	496.0	496.0	453.0	453.0	409.0	409.0	376.0	376.0	338.0	338.0
	BW	549.0	615.0 ⁽²⁾	537.0	560.0 ⁽²⁾	506.0	509.0 ⁽²⁾	461.0	462.0 ⁽²⁾	417.0	417.0	382.0	382.0	343.0	343.0
140	B	490.0	498.0 ⁽¹⁾	484.0	491.0 ⁽³⁾	470.0	470.0	441.0	441.0	401.0	401.0	368.0	368.0	331.0	331.0
	BW	491.0	597.0 ⁽²⁾	484.0	548.0 ⁽²⁾	475.0	498.0 ⁽²⁾	449.0	454.0 ⁽²⁾	408.0	409.0 ⁽²⁾	374.0	374.0	337.0	337.0
150	B	442.0	464.0 ⁽¹⁾	435.0	462.0 ⁽¹⁾	432.0	439.0 ⁽³⁾	418.0	418.0	390.0	390.0	360.0	360.0	324.0	324.0
	BW	442.0	555.0 ⁽²⁾	436.0	532.0 ⁽²⁾	433.0	488.0 ⁽²⁾	423.0	447.0 ⁽²⁾	397.0	402.0 ⁽²⁾	366.0	368.0 ⁽²⁾	330.0	330.0
160	B	400.0	429.0 ⁽¹⁾	394.0	437.0 ⁽¹⁾	391.0	407.0 ⁽³⁾	387.0	393.0 ⁽³⁾	372.0	372.0	350.0	350.0	318.0	318.0
	BW	399.0	515.0 ⁽¹⁾	394.0	499.0 ⁽²⁾	393.0	473.0 ⁽²⁾	390.0	440.0 ⁽²⁾	375.0	396.0 ⁽²⁾	356.0	362.0 ⁽²⁾	323.0	325.0 ⁽²⁾
170	B	363.0	394.0 ⁽¹⁾	358.0	412.0 ⁽¹⁾	355.0	377.0 ⁽¹⁾	354.0	369.0 ⁽³⁾	347.0	352.0 ⁽³⁾	334.0	334.0	310.0	310.0
	BW	363.0	491.0 ⁽¹⁾	358.0	466.0 ⁽²⁾	357.0	447.0 ⁽²⁾	355.0	427.0 ⁽²⁾	347.0	390.0 ⁽²⁾	337.0	356.0 ⁽²⁾	315.0	320.0 ⁽²⁾
180	B	338.0	361.0 ⁽⁵⁾	327.0	387.0 ⁽¹⁾	323.0	354.0 ⁽¹⁾	324.0	344.0 ⁽³⁾	316.0	332.0 ⁽³⁾	313.0	320.0 ⁽²⁾	296.0	297.0 ⁽²⁾
	BW	339.0	467.0 ⁽¹⁾	328.0	433.0 ⁽²⁾	325.0	422.0 ⁽²⁾	324.0	406.0 ⁽²⁾	317.0	378.0 ⁽²⁾	314.0	351.0 ⁽²⁾	298.0	315.0 ⁽²⁾
190	B	312.0	337.0 ⁽⁶⁾	303.0	362.0 ⁽¹⁾	296.0	331.0 ⁽¹⁾	296.0	320.0 ⁽³⁾	289.0	312.0 ⁽³⁾	287.0	301.0 ⁽²⁾	279.0	288.0 ⁽²⁾
	BW	312.0	443.0 ⁽¹⁾	304.0	406.0 ⁽²⁾	296.0	397.0 ⁽²⁾	295.0	385.0 ⁽²⁾	289.0	360.0 ⁽²⁾	288.0	339.0 ⁽²⁾	279.0	311.0 ⁽²⁾
200	B	279.0	316.0 ⁽⁷⁾	283.0	337.0 ⁽¹⁾	274.0	309.0 ⁽¹⁾	272.0	301.0 ⁽⁴⁾	265.0	291.0 ⁽³⁾	263.0	284.0 ⁽³⁾	255.0	270.0 ⁽²⁾
	BW	278.0	419.0 ⁽¹⁾	284.0	381.0 ⁽²⁾	274.0	373.0 ⁽²⁾	272.0	364.0 ⁽²⁾	265.0	343.0 ⁽²⁾	263.0	323.0 ⁽²⁾	255.0	300.0 ⁽²⁾
220	B	201.0	278.0 ⁽⁸⁾	232.0	287.0 ⁽¹⁾	237.0	265.0 ⁽⁵⁾	233.0	264.0 ⁽⁵⁾	223.0	255.0 ⁽⁴⁾	222.0	249.0 ⁽⁴⁾	214.0	239.0 ⁽³⁾
	BW	201.0	372.0 ⁽¹⁾	232.0	332.0 ⁽³⁾	237.0	328.0 ⁽²⁾	233.0	324.0 ⁽²⁾	224.0	308.0 ⁽²⁾	222.0	292.0 ⁽²⁾	215.0	274.0 ⁽²⁾
240	B		239.0 ⁽⁹⁾	167.0	237.0 ⁽⁸⁾	194.0	230.0 ⁽⁶⁾	201.0	226.0 ⁽⁶⁾	191.0	221.0 ⁽⁵⁾	188.0	217.0 ⁽⁴⁾	181.0	209.0 ⁽⁴⁾
	BW		324.0 ⁽¹⁾	167.0	289.0 ⁽³⁾	194.0	284.0 ⁽³⁾	201.0	284.0 ⁽²⁾	191.0	274.0 ⁽²⁾	189.0	263.0 ⁽²⁾	182.0	248.0 ⁽²⁾
260	B		209.0 ⁽¹¹⁾		206.0 ⁽⁹⁾	138.0	202.0 ⁽⁸⁾	164.0	197.0 ⁽⁷⁾	166.0	191.0 ⁽⁶⁾	162.0	188.0 ⁽⁵⁾	154.0	179.0 ⁽⁴⁾
	BW		276.0 ⁽¹⁾		252.0 ⁽⁴⁾	138.0	247.0 ⁽³⁾	164.0	245.0 ⁽³⁾	167.0	240.0 ⁽²⁾	163.0	234.0 ⁽²⁾	155.0	223.0 ⁽²⁾
280	B		171.0 ⁽¹¹⁾		178.0 ⁽¹⁰⁾		179.0 ⁽⁹⁾	117.0	176.0 ⁽⁸⁾	135.0	167.0 ⁽⁶⁾	140.0	162.0 ⁽⁶⁾	134.0	156.0 ⁽⁵⁾
	BW		231.0 ⁽⁸⁾		224.0 ⁽⁶⁾		218.0 ⁽⁴⁾	116.0	215.0 ⁽⁴⁾	135.0	208.0 ⁽³⁾	141.0	205.0 ⁽²⁾	134.0	197.0 ⁽²⁾
300	B		136.0 ⁽⁹⁾		150.0 ⁽¹¹⁾		156.0 ⁽¹⁰⁾		157.0 ⁽⁹⁾	92.0	149.0 ⁽⁸⁾	111.0	143.0 ⁽⁶⁾	115.0	135.0 ⁽⁴⁾
	BW		200.0 ⁽⁹⁾		203.0 ⁽⁸⁾		196.0 ⁽⁶⁾		191.0 ⁽⁴⁾	92.2	184.0 ⁽⁴⁾	113.0	180.0 ⁽³⁾	115.0	172.0 ⁽²⁾
320	B		109.0 ⁽⁹⁾		120.0 ⁽⁹⁾		129.0 ⁽¹¹⁾		135.0 ⁽¹⁰⁾		133.0 ⁽⁹⁾	73.9	128.0 ⁽⁸⁾	89.1	119.0 ⁽⁷⁾
	BW		165.0 ⁽⁹⁾		177.0 ⁽⁹⁾		179.0 ⁽⁸⁾		173.0 ⁽⁶⁾		164.0 ⁽⁵⁾	74.1	160.0 ⁽⁴⁾	89.1	152.0 ⁽³⁾
340	B		82.1 ⁽⁷⁾		92.6 ⁽⁹⁾		102.0 ⁽⁹⁾		111.0 ⁽¹⁰⁾		112.0 ⁽¹⁰⁾		113.0 ⁽⁹⁾	56.8	107.0 ⁽⁸⁾
	BW		132.0 ⁽⁷⁾		146.0 ⁽⁹⁾		156.0 ⁽⁹⁾		158.0 ⁽⁸⁾		147.0 ⁽⁶⁾		142.0 ⁽⁶⁾	57.1	135.0 ⁽⁴⁾
360	B				69.8 ⁽⁷⁾		79.1 ⁽⁹⁾		86.0 ⁽⁹⁾		90.5 ⁽¹⁰⁾		94.4 ⁽¹⁰⁾		91.8 ⁽⁹⁾
	BW				117.0 ⁽⁷⁾		130.0 ⁽⁹⁾		135.0 ⁽⁹⁾		131.0 ⁽⁸⁾		125.0 ⁽⁶⁾		119.0 ⁽⁵⁾
380	B						56.3 ⁽⁷⁾		64.8 ⁽⁹⁾		68.2 ⁽⁹⁾		74.2 ⁽¹⁰⁾		73.7 ⁽¹⁰⁾
	BW						99.7 ⁽⁷⁾		113.0 ⁽⁹⁾		113.0 ⁽⁹⁾		111.0 ⁽⁸⁾		102.0 ⁽⁵⁾
400	B								44.8 ⁽⁷⁾		45.5 ⁽⁷⁾		53.3 ⁽⁹⁾		56.5 ⁽¹⁰⁾
	BW								87.3 ⁽⁷⁾		91.7 ⁽⁷⁾		95.7 ⁽⁹⁾		87.5 ⁽⁹⁾
420	B										29.2 ⁽⁷⁾		31.7 ⁽⁹⁾		36.7 ⁽⁹⁾
	BW										73.2 ⁽⁷⁾		75.8 ⁽⁷⁾		75.3 ⁽⁹⁾
440	B												15.8 ⁽⁷⁾		
	BW												58.3 ⁽⁷⁾		59.0 ⁽⁷⁾
460	B														
	BW														42.8 ⁽⁷⁾

1) 12° 2) 17° 3) 22° 4) 27° 5) 32° 6) 37° 7) 42° 8) 47° 9) 52° 10) 57° 11) 62°

PDW3B/PDW3BW

P 217

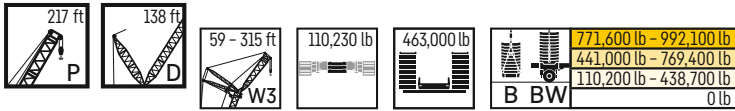

ft	B BW	P 217 ft													
		W3 59 ft		W3 79 ft		W3 98 ft		W3 118 ft		W3 138 ft		W3 158 ft		W3 177 ft	
		87°/85	WVmax	87°/85	WVmax	87°/85	WVmax	87°/85	WVmax	87°/85	WVmax	87°/85	WVmax	87°/85	WVmax
50	B	1244.0*	1281.0 ⁽²⁾	1197.0*	1197.0*										
	BW	1265.0*	1316.0 ⁽²⁾	1217.0*	1217.0*										
60	B	1217.0	1219.0 ⁽²⁾	1167.0	1167.0	1055.0*	1102.0 ⁽¹¹⁾	985.0*	1000.0 ⁽¹¹⁾						
	BW	1267.0	1303.0 ⁽²⁾	1233.0	1233.0	1080.0*	1145.0 ⁽¹¹⁾	1007.0*	1024.0 ⁽¹¹⁾						
70	B	988.0	1101.0 ⁽³⁾	1056.0	1062.0 ⁽²⁾	1034.0	1037.0 ⁽¹¹⁾	993.0	993.0	870.0*	902.0 ⁽¹¹⁾	801.0*	806.0 ⁽¹¹⁾	729.0*	729.0*
	BW	985.0	1235.0 ⁽²⁾	1083.0	1148.0 ⁽²⁾	1106.0	1118.0 ⁽¹¹⁾	1032.0	1033.0 ⁽¹¹⁾	889.0*	922.0 ⁽¹¹⁾	812.0*	818.0 ⁽¹¹⁾		
80	B	773.0	984.0 ⁽³⁾	862.0	962.0 ⁽²⁾	953.0	953.0	919.0	919.0	869.0	869.0	810.0	810.0	709.0*	709.0*
	BW	774.0	1168.0 ⁽²⁾	860.0	1094.0 ⁽²⁾	1021.0	1069.0 ⁽¹¹⁾	979.0	999.0 ⁽¹¹⁾	912.0	912.0	826.0	826.0	720.0*	720.0*
90	B		877.0 ⁽³⁾	706.0	866.0 ⁽³⁾	875.0	875.0	850.0	850.0	808.0	808.0	776.0	776.0	715.0	715.0
	BW		1083.0 ⁽²⁾	706.0	1039.0 ⁽²⁾	928.0	1021.0 ⁽¹¹⁾	909.0	964.0 ⁽¹¹⁾	869.0	879.0 ⁽²⁾	805.0	805.0	733.0	733.0
100	B		787.0 ⁽⁶⁾	590.0	778.0 ⁽³⁾	791.0	793.0 ⁽⁵⁾	777.0	777.0	752.0	752.0	726.0	738.0 ⁽¹¹⁾	690.0	690.0
	BW		998.0 ⁽²⁾	589.0	967.0 ⁽²⁾	813.0	956.0 ⁽²⁾	828.0	923.0 ⁽¹¹⁾	808.0	846.0 ⁽²⁾	768.0	781.0 ⁽²⁾	711.0	711.0
110	B		703.0 ⁽⁶⁾		705.0 ⁽⁵⁾	684.0	718.0 ⁽⁶⁾	708.0	710.0 ⁽⁵⁾	699.0	699.0	681.0	702.0 ⁽¹¹⁾	656.0	656.0
	BW		919.0 ⁽²⁾		896.0 ⁽²⁾	685.0	892.0 ⁽³⁾	735.0	866.0 ⁽²⁾	733.0	813.0 ⁽²⁾	715.0	760.0 ⁽²⁾	681.0	696.0 ⁽²⁾
120	B		632.0 ⁽⁴⁾		635.0 ⁽⁵⁾	533.0	649.0 ⁽⁷⁾	648.0	648.0	636.0	642.0 ⁽¹¹⁾	628.0	666.0 ⁽¹¹⁾	616.0	616.0
	BW		842.0 ⁽²⁾		829.0 ⁽²⁾	533.0	828.0 ⁽⁴⁾	648.0	813.0 ⁽³⁾	642.0	774.0 ⁽²⁾	638.0	739.0 ⁽²⁾	633.0	684.0 ⁽²⁾
130	B		577.0 ⁽⁸⁾		572.0 ⁽⁶⁾		586.0 ⁽⁸⁾	565.0	594.0 ⁽⁷⁾	569.0	595.0 ⁽¹¹⁾	562.0	629.0 ⁽¹¹⁾	562.0	567.0 ⁽³⁾
	BW		769.0 ⁽³⁾		764.0 ⁽²⁾		758.0 ⁽⁴⁾	568.0	753.0 ⁽⁴⁾	568.0	730.0 ⁽¹¹⁾	565.0	707.0 ⁽²⁾	565.0	672.0 ⁽²⁾
140	B		527.0 ⁽⁹⁾		526.0 ⁽⁷⁾		539.0 ⁽⁹⁾	451.0	540.0 ⁽⁸⁾	513.0	549.0 ⁽¹¹⁾	503.0	593.0 ⁽¹¹⁾	504.0	524.0 ⁽⁴⁾
	BW		700.0 ⁽⁴⁾		702.0 ⁽³⁾		698.0 ⁽²⁾	452.0	694.0 ⁽⁴⁾	512.0	685.0 ⁽¹¹⁾	506.0	663.0 ⁽²⁾	505.0	645.0 ⁽²⁾
150	B		477.0 ⁽⁹⁾		486.0 ⁽¹⁰⁾		492.0 ⁽⁹⁾		494.0 ⁽⁸⁾	463.0	502.0 ⁽¹¹⁾	459.0	557.0 ⁽¹¹⁾	453.0	484.0 ⁽⁴⁾
	BW		634.0 ⁽⁵⁾		642.0 ⁽³⁾		646.0 ⁽⁵⁾		639.0 ⁽²⁾	463.0	648.0 ⁽¹¹⁾	460.0	620.0 ⁽²⁾	454.0	609.0 ⁽²⁾
160	B		427.0 ⁽⁹⁾		446.0 ⁽¹⁰⁾		447.0 ⁽¹⁰⁾		457.0 ⁽⁹⁾	382.0	455.0 ⁽¹¹⁾	418.0	520.0 ⁽¹¹⁾	411.0	450.0 ⁽¹¹⁾
	BW		583.0 ⁽⁸⁾		582.0 ⁽⁴⁾		602.0 ⁽⁷⁾		595.0 ⁽⁴⁾	383.0	611.0 ⁽¹¹⁾	419.0	580.0 ⁽²⁾	410.0	572.0 ⁽²⁾
170	B				406.0 ⁽¹⁰⁾		412.0 ⁽¹⁰⁾		420.0 ⁽¹⁰⁾		424.0 ⁽⁹⁾	369.0	484.0 ⁽¹¹⁾	376.0	418.0 ⁽¹¹⁾
	BW				537.0 ⁽⁵⁾		559.0 ⁽⁷⁾		556.0 ⁽⁶⁾		574.0 ⁽¹¹⁾	369.0	543.0 ⁽²⁾	376.0	537.0 ⁽²⁾
180	B				366.0 ⁽¹⁰⁾		379.0 ⁽¹⁰⁾		384.0 ⁽¹¹⁾		397.0 ⁽¹⁰⁾	310.0	447.0 ⁽¹¹⁾	347.0	387.0 ⁽⁶⁾
	BW				504.0 ⁽⁹⁾		516.0 ⁽⁷⁾		518.0 ⁽⁶⁾		537.0 ⁽¹¹⁾	310.0	508.0 ⁽³⁾	347.0	505.0 ⁽²⁾
190	B						345.0 ⁽¹⁰⁾		354.0 ⁽¹⁰⁾		365.0 ⁽¹⁰⁾		411.0 ⁽¹¹⁾	309.0	362.0 ⁽⁷⁾
	BW						474.0 ⁽⁸⁾		482.0 ⁽⁷⁾		500.0 ⁽¹¹⁾		474.0 ⁽³⁾	309.0	472.0 ⁽²⁾
200	B						312.0 ⁽¹⁰⁾		326.0 ⁽¹⁰⁾		335.0 ⁽¹¹⁾		375.0 ⁽¹¹⁾	261.0	342.0 ⁽⁸⁾
	BW						438.0 ⁽¹⁰⁾		448.0 ⁽⁸⁾		463.0 ⁽¹¹⁾		442.0 ⁽⁴⁾	261.0	439.0 ⁽²⁾
220	B								269.0 ⁽¹⁰⁾		284.0 ⁽¹⁰⁾		302.0 ⁽¹¹⁾		295.0 ⁽⁹⁾
	BW								385.0 ⁽¹⁰⁾		389.0 ⁽¹¹⁾		382.0 ⁽⁴⁾		382.0 ⁽³⁾
240	B								218.0 ⁽⁸⁾		233.0 ⁽⁸⁾		246.0 ⁽¹⁰⁾		257.0 ⁽¹¹⁾
	BW								333.0 ⁽⁸⁾		341.0 ⁽⁸⁾		336.0 ⁽⁶⁾		333.0 ⁽⁴⁾
260	B										194.0 ⁽⁸⁾		201.0 ⁽⁸⁾		220.0 ⁽¹¹⁾
	BW										297.0 ⁽⁸⁾		301.0 ⁽⁸⁾		300.0 ⁽⁴⁾
280	B										155.0 ⁽⁶⁾		168.0 ⁽⁸⁾		179.0 ⁽⁹⁾
	BW										252.0 ⁽⁶⁾		262.0 ⁽⁸⁾		272.0 ⁽⁹⁾
300	B										127.0 ⁽⁶⁾		136.0 ⁽⁶⁾		150.0 ⁽⁹⁾
	BW										215.0 ⁽⁶⁾		218.0 ⁽⁶⁾		237.0 ⁽⁹⁾
320	B												111.0 ⁽⁶⁾		120.0 ⁽⁷⁾
	BW												179.0 ⁽⁶⁾		199.0 ⁽⁷⁾
340	B														95.9 ⁽⁶⁾
	BW														164.0 ⁽⁷⁾

1) 12° 2) 17° 3) 22° 4) 27° 5) 32° 6) 37° 7) 42° 8) 47° 9) 52° 10) 57° 11) 62°

PDW3B/PDW3BW

P 217

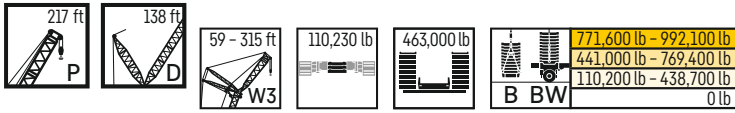

ft	B BW	P 217 ft													
		W3 197 ft		W3 217 ft		W3 236 ft		W3 256 ft		W3 276 ft		W3 295 ft		W3 315 ft	
		87°/85	WVmax	87°/85	WVmax	87°/85	WVmax	87°/85	WVmax	87°/85	WVmax	87°/85	WVmax	87°/85	WVmax
80	B	644.0*	644.0*												
	BW	654.0*	654.0*												
90	B	623.0*	623.0*	570.0*	570.0*	516.0*	516.0*								
	BW	638.0*	638.0*	582.0*	582.0*	526.0*	526.0*								
100	B	629.0	629.0	573.0	573.0	500.0*	500.0*	457.0*	457.0*	413.0*	413.0*				
	BW	645.0	645.0	586.0	586.0	511.0*	511.0*	466.0*	466.0*	421.0*	421.0*				
110	B	608.0	608.0	558.0	558.0	504.0	504.0	445.0*	445.0*	403.0*	403.0*	370.0*	370.0*	314.0*	314.0*
	BW	628.0	629.0 ⁽²⁾	572.0	572.0	518.0	518.0	454.0*	454.0*	410.0*	410.0*	377.0*	377.0*	322.0*	322.0*
120	B	583.0	583.0	542.0	542.0	492.0	492.0	449.0	449.0	405.0	405.0	361.0*	361.0*	326.0*	326.0*
	BW	606.0	620.0 ⁽²⁾	557.0	560.0 ⁽²⁾	505.0	505.0	459.0	459.0	414.0	414.0	368.0*	368.0*	331.0*	331.0*
130	B	547.0	547.0	521.0	521.0	478.0	478.0	439.0	439.0	396.0	396.0	364.0	364.0	326.0	326.0
	BW	559.0	612.0 ⁽²⁾	536.0	552.0 ⁽²⁾	493.0	496.0 ⁽²⁾	449.0	449.0	405.0	405.0	372.0	372.0	334.0	334.0
140	B	498.0	509.0 ⁽³⁾	490.0	491.0 ⁽³⁾	461.0	461.0	426.0	426.0	387.0	387.0	355.0	355.0	320.0	320.0
	BW	502.0	603.0 ⁽²⁾	497.0	545.0 ⁽²⁾	473.0	490.0 ⁽²⁾	439.0	443.0 ⁽²⁾	397.0	397.0	364.0	364.0	328.0	328.0
150	B	450.0	471.0 ⁽³⁾	447.0	461.0 ⁽²⁾	436.0	439.0 ⁽²⁾	411.0	413.0 ⁽²⁾	377.0	378.0 ⁽²⁾	348.0	348.0	314.0	314.0
	BW	450.0	579.0 ⁽²⁾	449.0	537.0 ⁽²⁾	439.0	483.0 ⁽²⁾	421.0	437.0 ⁽²⁾	387.0	392.0 ⁽²⁾	357.0	357.0	321.0	321.0
160	B	407.0	438.0 ⁽⁴⁾	405.0	431.0 ⁽³⁾	399.0	420.0 ⁽²⁾	389.0	400.0 ⁽²⁾	363.0	369.0 ⁽²⁾	339.0	342.0 ⁽²⁾	307.0	309.0 ⁽²⁾
	BW	407.0	550.0 ⁽²⁾	407.0	516.0 ⁽²⁾	399.0	477.0 ⁽²⁾	394.0	432.0 ⁽²⁾	372.0	387.0 ⁽²⁾	347.0	353.0 ⁽²⁾	315.0	317.0 ⁽²⁾
170	B	370.0	407.0 ⁽⁴⁾	367.0	400.0 ⁽³⁾	363.0	390.0 ⁽²⁾	359.0	386.0 ⁽²⁾	344.0	360.0 ⁽²⁾	326.0	335.0 ⁽²⁾	299.0	304.0 ⁽²⁾
	BW	370.0	520.0 ⁽²⁾	369.0	492.0 ⁽²⁾	363.0	456.0 ⁽²⁾	360.0	425.0 ⁽²⁾	351.0	382.0 ⁽²⁾	335.0	348.0 ⁽²⁾	307.0	312.0 ⁽²⁾
180	B	343.0	380.0 ⁽⁵⁾	335.0	376.0 ⁽⁴⁾	329.0	366.0 ⁽³⁾	328.0	358.0 ⁽²⁾	319.0	348.0 ⁽²⁾	310.0	329.0 ⁽²⁾	287.0	300.0 ⁽²⁾
	BW	343.0	492.0 ⁽²⁾	337.0	469.0 ⁽²⁾	330.0	435.0 ⁽²⁾	329.0	408.0 ⁽²⁾	321.0	376.0 ⁽²⁾	318.0	344.0 ⁽²⁾	296.0	308.0 ⁽²⁾
190	B	317.0	355.0 ⁽⁵⁾	310.0	350.0 ⁽⁴⁾	300.0	342.0 ⁽⁴⁾	300.0	338.0 ⁽³⁾	294.0	323.0 ⁽²⁾	289.0	318.0 ⁽²⁾	273.0	295.0 ⁽²⁾
	BW	317.0	463.0 ⁽²⁾	310.0	446.0 ⁽²⁾	302.0	415.0 ⁽²⁾	300.0	391.0 ⁽²⁾	293.0	361.0 ⁽²⁾	293.0	338.0 ⁽²⁾	283.0	304.0 ⁽²⁾
200	B	284.0	334.0 ⁽⁶⁾	290.0	330.0 ⁽⁵⁾	277.0	320.0 ⁽⁴⁾	276.0	314.0 ⁽³⁾	270.0	307.0 ⁽³⁾	268.0	295.0 ⁽²⁾	256.0	284.0 ⁽²⁾
	BW	284.0	435.0 ⁽²⁾	291.0	422.0 ⁽²⁾	278.0	394.0 ⁽²⁾	276.0	374.0 ⁽²⁾	270.0	346.0 ⁽²⁾	268.0	325.0 ⁽²⁾	261.0	298.0 ⁽²⁾
220	B	209.0	291.0 ⁽⁷⁾	240.0	287.0 ⁽⁶⁾	241.0	278.0 ⁽⁵⁾	236.0	276.0 ⁽⁴⁾	228.0	267.0 ⁽⁴⁾	224.0	261.0 ⁽³⁾	219.0	253.0 ⁽³⁾
	BW	210.0	378.0 ⁽²⁾	239.0	374.0 ⁽²⁾	241.0	356.0 ⁽²⁾	236.0	341.0 ⁽²⁾	228.0	317.0 ⁽²⁾	225.0	299.0 ⁽²⁾	218.0	277.0 ⁽²⁾
240	B		252.0 ⁽⁸⁾	178.0	250.0 ⁽⁸⁾	199.0	241.0 ⁽⁶⁾	207.0	239.0 ⁽⁵⁾	197.0	231.0 ⁽⁴⁾	192.0	227.0 ⁽⁴⁾	184.0	217.0 ⁽³⁾
	BW		329.0 ⁽³⁾	178.0	327.0 ⁽²⁾	199.0	318.0 ⁽²⁾	204.0	310.0 ⁽²⁾	198.0	291.0 ⁽²⁾	191.0	291.0 ⁽²⁾	184.0	257.0 ⁽²⁾
260	B		223.0 ⁽¹⁰⁾		221.0 ⁽⁸⁾	146.0	213.0 ⁽⁷⁾	169.0	209.0 ⁽⁶⁾	170.0	202.0 ⁽⁵⁾	164.0	196.0 ⁽⁴⁾	158.0	188.0 ⁽⁴⁾
	BW		292.0 ⁽⁴⁾		288.0 ⁽³⁾	146.0	280.0 ⁽²⁾	169.0	278.0 ⁽²⁾	170.0	265.0 ⁽²⁾	165.0	253.0 ⁽²⁾	158.0	235.0 ⁽²⁾
280	B		189.0 ⁽¹⁰⁾		196.0 ⁽¹⁰⁾		190.0 ⁽⁸⁾	123.0	186.0 ⁽⁷⁾	138.0	178.0 ⁽⁶⁾	143.0	173.0 ⁽⁵⁾	135.0	163.0 ⁽⁵⁾
	BW		265.0 ⁽⁶⁾		259.0 ⁽⁴⁾		251.0 ⁽³⁾	123.0	246.0 ⁽²⁾	138.0	239.0 ⁽²⁾	144.0	230.0 ⁽²⁾	135.0	215.0 ⁽²⁾
300	B		154.0 ⁽⁹⁾		166.0 ⁽¹⁰⁾		169.0 ⁽¹⁰⁾		166.0 ⁽⁸⁾	96.8	160.0 ⁽⁷⁾	116.0	154.0 ⁽⁶⁾	116.0	144.0 ⁽⁵⁾
	BW		238.0 ⁽⁸⁾		234.0 ⁽⁵⁾		227.0 ⁽⁴⁾		222.0 ⁽³⁾	99.1	213.0 ⁽²⁾	116.0	208.0 ⁽²⁾	117.0	195.0 ⁽²⁾
320	B		128.0 ⁽⁹⁾		134.0 ⁽⁹⁾		142.0 ⁽¹⁰⁾		144.0 ⁽⁹⁾		142.0 ⁽⁹⁾	79.0	137.0 ⁽⁷⁾	92.2	128.0 ⁽⁶⁾
	BW		207.0 ⁽⁸⁾		207.0 ⁽⁸⁾		200.0 ⁽⁵⁾		196.0 ⁽³⁾		188.0 ⁽²⁾	79.1	185.0 ⁽²⁾	92.1	174.0 ⁽²⁾
340	B		101.0 ⁽⁷⁾		110.0 ⁽⁹⁾		113.0 ⁽⁹⁾		121.0 ⁽¹⁰⁾		121.0 ⁽⁹⁾		121.0 ⁽⁹⁾	61.0	112.0 ⁽⁷⁾
	BW		174.0 ⁽⁷⁾		183.0 ⁽⁸⁾		176.0 ⁽⁵⁾		173.0 ⁽⁴⁾		166.0 ⁽³⁾		162.0 ⁽²⁾	61.2	155.0 ⁽²⁾
360	B		78.6 ⁽⁷⁾		84.8 ⁽⁷⁾		90.3 ⁽⁹⁾		96.6 ⁽⁹⁾		100.0 ⁽¹⁰⁾		101.0 ⁽⁹⁾		96.4 ⁽⁹⁾
	BW		144.0 ⁽⁷⁾		156.0 ⁽⁷⁾		156.0 ⁽⁸⁾		153.0 ⁽⁷⁾		146.0 ⁽⁴⁾		142.0 ⁽³⁾		135.0 ⁽²⁾
380	B				64.3 ⁽⁷⁾		66.7 ⁽⁷⁾		75.3 ⁽⁹⁾		77.9 ⁽⁹⁾		82.8 ⁽¹⁰⁾		79.3 ⁽⁹⁾
	BW				129.0 ⁽⁷⁾		135.0 ⁽⁷⁾		138.0 ⁽⁸⁾		129.0 ⁽⁵⁾		124.0 ⁽⁴⁾		118.0 ⁽³⁾
400	B						48.1 ⁽⁷⁾		53.1 ⁽⁷⁾		58.5 ⁽⁹⁾		62.4 ⁽⁹⁾		63.6 ⁽¹⁰⁾
	BW						113.0 ⁽⁷⁾		118.0 ⁽⁷⁾		116.0 ⁽⁷⁾		111.0 ⁽⁵⁾		103.0 ⁽⁴⁾
420	B								35.7 ⁽⁷⁾		37.0 ⁽⁷⁾		43.8 ⁽⁹⁾		44.6 ⁽⁹⁾
	BW								97.4 ⁽⁷⁾		99.5 ⁽⁷⁾		99.5 ⁽⁷⁾		91.3 ⁽⁵⁾
440	B										20.4 ⁽⁷⁾				26.8 ⁽⁹⁾
	BW										80.4 ⁽⁷⁾		83.6 ⁽⁷⁾		81.5 ⁽⁷⁾
460	B														
	BW														66.6 ⁽⁷⁾

1) 12° 2) 17° 3) 22° 4) 27° 5) 32° 6) 37° 7) 42° 8) 47° 9) 52° 10) 57° 11) 62°

PDW3B/PDW3BW

P 236

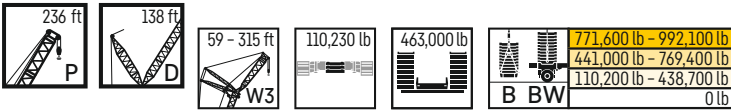

ft	B BW	P 236 ft													
		W3 59 ft		W3 79 ft		W3 98 ft		W3 118 ft		W3 138 ft		W3 158 ft		W3 177 ft	
		87°/85	WVmax	87°/85	WVmax	87°/85	WVmax	87°/85	WVmax	87°/85	WVmax	87°/85	WVmax	87°/85	WVmax
50	B	1180.0*	1206.0 ⁽²⁾	1130.0*	1130.0*										
	BW	1204.0*	1237.0 ⁽²⁾	1155.0*	1155.0*										
60	B	1177.0	1179.0 ⁽²⁾	1125.0	1125.0	990.0*	1038.0 ⁽¹⁾	928.0*	935.0 ⁽¹⁾						
	BW	1224.0	1239.0 ⁽²⁾	1176.0	1176.0	1015.0*	1062.0 ⁽¹⁾	947.0*	957.0 ⁽¹⁾						
70	B	1030.0	1073.0 ⁽²⁾	1029.0	1030.0 ⁽²⁾	1000.0	1000.0	942.0	942.0	821.0*	854.0 ⁽¹⁾	766.0*	771.0 ⁽¹⁾		
	BW	1035.0	1183.0 ⁽²⁾	1068.0	1094.0 ⁽²⁾	1043.0	1048.0 ⁽¹⁾	973.0	973.0	838.0*	873.0 ⁽¹⁾	779.0*	779.0*		
80	B	809.0	968.0 ⁽⁴⁾	899.0	941.0 ⁽³⁾	924.0	924.0	873.0	876.0 ⁽¹⁾	838.0	839.0 ⁽¹⁾	787.0	787.0	681.0*	681.0*
	BW	809.0	1127.0 ⁽²⁾	896.0	1052.0 ⁽²⁾	976.0	1013.0 ⁽¹⁾	927.0	938.0 ⁽¹⁾	870.0	870.0	744.0*	747.0 ⁽¹⁾	696.0*	696.0*
90	B		866.0 ⁽²⁾	733.0	853.0 ⁽³⁾	855.0	855.0	811.0	811.0	783.0	783.0	743.0	751.0 ⁽¹⁾	689.0	689.0
	BW		1055.0 ⁽²⁾	730.0	1011.0 ⁽²⁾	897.0	979.0 ⁽¹⁾	867.0	905.0 ⁽¹⁾	824.0	833.0 ⁽¹⁾	773.0	773.0	711.0	711.0
100	B		778.0 ⁽⁶⁾	613.0	768.0 ⁽⁴⁾	779.0	780.0 ⁽⁵⁾	754.0	754.0	730.0	730.0	697.0	718.0 ⁽¹⁾	659.0	659.0
	BW		976.0 ⁽²⁾	612.0	948.0 ⁽²⁾	816.0	926.0 ⁽¹⁾	794.0	873.0 ⁽¹⁾	769.0	805.0 ⁽²⁾	728.0	739.0 ⁽²⁾	683.0	683.0
110	B		702.0 ⁽⁷⁾		696.0 ⁽⁵⁾	706.0	710.0 ⁽⁷⁾	697.0	697.0	680.0	680.0	653.0	684.0 ⁽¹⁾	622.0	622.0
	BW		897.0 ⁽³⁾		879.0 ⁽²⁾	713.0	873.0 ⁽³⁾	729.0	826.0 ⁽¹⁾	711.0	781.0 ⁽²⁾	680.0	724.0 ⁽²⁾	646.0	667.0 ⁽²⁾
120	B		630.0 ⁽⁸⁾		635.0 ⁽⁶⁾	563.0	646.0 ⁽⁷⁾	639.0	640.0 ⁽⁶⁾	627.0	628.0 ⁽¹⁾	608.0	650.0 ⁽¹⁾	585.0	585.0
	BW		798.0 ⁽⁶⁾		812.0 ⁽²⁾	564.0	816.0 ⁽⁴⁾	663.0	777.0 ⁽¹⁾	651.0	755.0 ⁽²⁾	632.0	709.0 ⁽²⁾	606.0	659.0 ⁽²⁾
130	B		566.0 ⁽¹¹⁾		575.0 ⁽⁷⁾		584.0 ⁽⁸⁾	580.0	586.0 ⁽⁷⁾	576.0	585.0 ⁽¹⁾	563.0	617.0 ⁽¹⁾	549.0	549.0
	BW		590.0 ⁽¹¹⁾		753.0 ⁽²⁾		758.0 ⁽²⁾	589.0	734.0 ⁽⁴⁾	584.0	714.0 ⁽³⁾	578.0	690.0 ⁽²⁾	565.0	651.0 ⁽²⁾
140	B				522.0 ⁽⁸⁾		533.0 ⁽⁹⁾	475.0	537.0 ⁽⁸⁾	520.0	542.0 ⁽¹⁾	516.0	583.0 ⁽¹⁾	510.0	512.0 ⁽⁴⁾
	BW				695.0 ⁽³⁾		695.0 ⁽⁵⁾	478.0	684.0 ⁽⁵⁾	522.0	668.0 ⁽³⁾	518.0	649.0 ⁽²⁾	514.0	635.0 ⁽²⁾
150	B				480.0 ⁽¹⁰⁾		491.0 ⁽¹⁰⁾		491.0 ⁽⁸⁾	475.0	499.0 ⁽¹⁾	469.0	550.0 ⁽¹⁾	464.0	476.0 ⁽⁴⁾
	BW				641.0 ⁽⁴⁾		637.0 ⁽³⁾		635.0 ⁽⁵⁾	474.0	629.0 ⁽¹⁾	469.0	610.0 ⁽³⁾	462.0	599.0 ⁽²⁾
160	B				443.0 ⁽¹⁰⁾		447.0 ⁽¹⁰⁾		453.0 ⁽⁹⁾	403.0	455.0 ⁽¹⁾	428.0	516.0 ⁽¹⁾	422.0	443.0 ⁽⁵⁾
	BW				589.0 ⁽⁴⁾		593.0 ⁽⁷⁾		586.0 ⁽⁵⁾	403.0	595.0 ⁽¹⁾	430.0	572.0 ⁽³⁾	419.0	563.0 ⁽²⁾
170	B				406.0 ⁽¹⁰⁾		407.0 ⁽¹⁰⁾		419.0 ⁽¹⁰⁾		420.0 ⁽⁹⁾	381.0	482.0 ⁽¹⁾	384.0	411.0 ⁽⁵⁾
	BW				537.0 ⁽⁴⁾		554.0 ⁽⁸⁾		548.0 ⁽⁶⁾		562.0 ⁽¹⁾	381.0	534.0 ⁽²⁾	380.0	526.0 ⁽²⁾
180	B				369.0 ⁽¹⁰⁾		375.0 ⁽¹⁰⁾		382.0 ⁽¹¹⁾		393.0 ⁽¹⁰⁾	325.0	449.0 ⁽¹⁾	356.0	383.0 ⁽⁶⁾
	BW				494.0 ⁽⁶⁾		515.0 ⁽⁸⁾		513.0 ⁽⁷⁾		528.0 ⁽¹⁾	325.0	501.0 ⁽³⁾	354.0	495.0 ⁽²⁾
190	B				330.0 ⁽⁸⁾		344.0 ⁽¹⁰⁾		350.0 ⁽¹⁰⁾		363.0 ⁽¹⁰⁾		415.0 ⁽¹⁾	319.0	357.0 ⁽⁷⁾
	BW				464.0 ⁽⁸⁾		476.0 ⁽⁸⁾		480.0 ⁽⁸⁾		494.0 ⁽¹⁾		469.0 ⁽³⁾	317.0	465.0 ⁽²⁾
200	B				305.0 ⁽⁸⁾		312.0 ⁽¹⁰⁾		323.0 ⁽¹⁰⁾		333.0 ⁽¹¹⁾		382.0 ⁽¹⁾	272.0	336.0 ⁽⁸⁾
	BW				433.0 ⁽⁸⁾		437.0 ⁽⁸⁾		447.0 ⁽⁸⁾		460.0 ⁽¹⁾		440.0 ⁽⁴⁾	271.0	437.0 ⁽³⁾
220	B				255.0 ⁽⁸⁾		257.0 ⁽⁷⁾		269.0 ⁽¹⁰⁾		282.0 ⁽¹⁰⁾		314.0 ⁽¹⁾		296.0 ⁽⁹⁾
	BW				372.0 ⁽⁸⁾		376.0 ⁽⁸⁾		383.0 ⁽⁹⁾		392.0 ⁽¹⁾		384.0 ⁽⁵⁾		382.0 ⁽⁴⁾
240	B						213.0 ⁽⁷⁾		222.0 ⁽⁸⁾		236.0 ⁽¹⁰⁾		247.0 ⁽¹⁾		253.0 ⁽¹⁰⁾
	BW						322.0 ⁽⁸⁾		330.0 ⁽⁸⁾		338.0 ⁽⁹⁾		334.0 ⁽⁶⁾		332.0 ⁽⁴⁾
260	B								184.0 ⁽⁸⁾		194.0 ⁽⁸⁾		204.0 ⁽¹⁰⁾		218.0 ⁽¹¹⁾
	BW								284.0 ⁽⁸⁾		294.0 ⁽⁸⁾		296.0 ⁽⁸⁾		293.0 ⁽⁴⁾
280	B										160.0 ⁽⁸⁾		167.0 ⁽⁸⁾		181.0 ⁽¹¹⁾
	BW										253.0 ⁽⁸⁾		259.0 ⁽⁸⁾		264.0 ⁽⁸⁾
300	B										130.0 ⁽⁶⁾		136.0 ⁽⁸⁾		148.0 ⁽⁹⁾
	BW										211.0 ⁽⁶⁾		223.0 ⁽⁸⁾		233.0 ⁽⁹⁾
320	B												109.0 ⁽⁶⁾		120.0 ⁽⁹⁾
	BW												187.0 ⁽⁶⁾		200.0 ⁽⁹⁾
340	B														94.6 ⁽⁷⁾
	BW														168.0 ⁽⁷⁾

1) 12° 2) 17° 3) 22° 4) 27° 5) 32° 6) 37° 7) 42° 8) 47° 9) 52° 10) 57° 11) 62°

PDW3B/PDW3BW

P 236

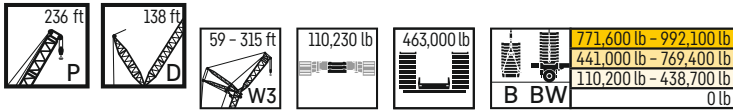

ft	B BW	P 236 ft													
		W3 197 ft		W3 217 ft		W3 236 ft		W3 256 ft		W3 276 ft		W3 295 ft		W3 315 ft	
		87°/85	WVmax	87°/85	WVmax	87°/85	WVmax	87°/85	WVmax	87°/85	WVmax	87°/85	WVmax	87°/85	WVmax
80	B	624.0*	624.0*												
	BW	635.0*	635.0*												
90	B	597.0*	597.0*	551.0*	551.0*	498.0*	498.0*								
	BW	614.0*	614.0*	564.0*	564.0*	510.0*	510.0*								
100	B	611.0	611.0	527.0*	527.0*	485.0*	485.0*	443.0*	443.0*						
	BW	627.0	627.0	546.0*	546.0*	496.0*	496.0*	452.0*	452.0*						
110	B	583.0	583.0	542.0	542.0	493.0	493.0	430.0*	430.0*	392.0*	392.0*	359.0*	359.0*		
	BW	608.0	608.0	557.0	557.0	503.0	503.0	440.0*	440.0*	398.0*	398.0*	366.0*	366.0*		
120	B	552.0	553.0 ⁽²⁾	520.0	521.0 ⁽²⁾	480.0	480.0	437.0	437.0	395.0	395.0	349.0*	349.0*	316.0*	
	BW	577.0	601.0 ⁽²⁾	539.0	543.0 ⁽²⁾	491.0	491.0	447.0	447.0	402.0	402.0	356.0*	356.0*	322.0*	
130	B	521.0	523.0 ⁽²⁾	493.0	497.0 ⁽²⁾	461.0	463.0 ⁽²⁾	426.0	426.0	387.0	387.0	354.0	354.0	306.0*	
	BW	541.0	596.0 ⁽²⁾	516.0	538.0 ⁽²⁾	477.0	483.0 ⁽²⁾	437.0	437.0	395.0	395.0	362.0	362.0	314.0*	
140	B	490.0	493.0 ⁽²⁾	467.0	473.0 ⁽²⁾	439.0	445.0 ⁽²⁾	408.0	412.0 ⁽²⁾	378.0	378.0	345.0	345.0	312.0	
	BW	504.0	592.0 ⁽²⁾	487.0	533.0 ⁽²⁾	460.0	478.0 ⁽²⁾	427.0	432.0 ⁽²⁾	387.0	387.0	354.0	354.0	319.0	
150	B	454.0	460.0 ⁽⁴⁾	440.0	449.0 ⁽²⁾	417.0	426.0 ⁽²⁾	389.0	398.0 ⁽²⁾	363.0	368.0 ⁽²⁾	336.0	337.0 ⁽²⁾	304.0	
	BW	458.0	577.0 ⁽²⁾	453.0	529.0 ⁽²⁾	435.0	473.0 ⁽²⁾	412.0	428.0 ⁽²⁾	378.0	383.0 ⁽²⁾	347.0	348.0 ⁽²⁾	313.0	
160	B	415.0	430.0 ⁽⁴⁾	409.0	421.0 ⁽²⁾	395.0	408.0 ⁽²⁾	370.0	384.0 ⁽²⁾	347.0	358.0 ⁽²⁾	323.0	329.0 ⁽²⁾	295.0	
	BW	415.0	546.0 ⁽⁴⁾	414.0	515.0 ⁽²⁾	404.0	468.0 ⁽²⁾	391.0	424.0 ⁽²⁾	366.0	379.0 ⁽²⁾	339.0	345.0 ⁽²⁾	307.0	
170	B	376.0	401.0 ⁽⁴⁾	375.0	394.0 ⁽³⁾	369.0	382.0 ⁽²⁾	351.0	370.0 ⁽²⁾	330.0	348.0 ⁽²⁾	309.0	322.0 ⁽²⁾	284.0	
	BW	377.0	516.0 ⁽²⁾	375.0	492.0 ⁽²⁾	370.0	456.0 ⁽²⁾	364.0	420.0 ⁽²⁾	348.0	376.0 ⁽²⁾	328.0	341.0 ⁽²⁾	299.0	
180	B	347.0	374.0 ⁽⁵⁾	342.0	369.0 ⁽⁴⁾	338.0	360.0 ⁽³⁾	330.0	347.0 ⁽²⁾	315.0	338.0 ⁽²⁾	294.0	314.0 ⁽²⁾	273.0	
	BW	347.0	485.0 ⁽²⁾	342.0	470.0 ⁽²⁾	336.0	439.0 ⁽²⁾	335.0	409.0 ⁽²⁾	324.0	372.0 ⁽²⁾	315.0	338.0 ⁽²⁾	290.0	
190	B	322.0	349.0 ⁽⁵⁾	314.0	344.0 ⁽⁴⁾	309.0	337.0 ⁽⁴⁾	305.0	327.0 ⁽³⁾	298.0	316.0 ⁽²⁾	281.0	306.0 ⁽²⁾	260.0	
	BW	321.0	458.0 ⁽²⁾	315.0	447.0 ⁽²⁾	306.0	422.0 ⁽²⁾	306.0	394.0 ⁽²⁾	298.0	361.0 ⁽²⁾	294.0	335.0 ⁽²⁾	279.0	
200	B	291.0	328.0 ⁽⁶⁾	295.0	325.0 ⁽⁵⁾	285.0	317.0 ⁽⁴⁾	281.0	306.0 ⁽⁴⁾	277.0	298.0 ⁽³⁾	266.0	285.0 ⁽²⁾	247.0	
	BW	291.0	430.0 ⁽²⁾	295.0	424.0 ⁽²⁾	281.0	406.0 ⁽²⁾	280.0	380.0 ⁽²⁾	274.0	348.0 ⁽²⁾	272.0	324.0 ⁽²⁾	262.0	
220	B	217.0	292.0 ⁽⁸⁾	243.0	285.0 ⁽⁶⁾	248.0	280.0 ⁽⁵⁾	238.0	271.0 ⁽⁵⁾	234.0	266.0 ⁽⁴⁾	228.0	253.0 ⁽³⁾	218.0	
	BW	218.0	377.0 ⁽³⁾	245.0	375.0 ⁽²⁾	245.0	364.0 ⁽²⁾	239.0	349.0 ⁽²⁾	231.0	324.0 ⁽²⁾	229.0	303.0 ⁽²⁾	223.0	
240	B		252.0 ⁽⁹⁾	183.0	253.0 ⁽⁸⁾	205.0	244.0 ⁽⁶⁾	207.0	239.0 ⁽⁵⁾	203.0	234.0 ⁽⁵⁾	194.0	225.0 ⁽⁴⁾	187.0	
	BW		328.0 ⁽³⁾	184.0	326.0 ⁽²⁾	203.0	321.0 ⁽²⁾	209.0	313.0 ⁽²⁾	200.0	295.0 ⁽²⁾	194.0	281.0 ⁽²⁾	189.0	
260	B		219.0 ⁽¹⁰⁾		219.0 ⁽⁹⁾	153.0	216.0 ⁽⁸⁾	173.0	208.0 ⁽⁶⁾	176.0	202.0 ⁽⁵⁾	166.0	197.0 ⁽⁵⁾	161.0	
	BW		287.0 ⁽⁴⁾		285.0 ⁽³⁾	151.0	278.0 ⁽²⁾	173.0	277.0 ⁽²⁾	173.0	265.0 ⁽²⁾	167.0	255.0 ⁽²⁾	161.0	
280	B		188.0 ⁽¹¹⁾		193.0 ⁽¹⁰⁾		189.0 ⁽⁹⁾	128.0	183.0 ⁽⁷⁾	144.0	177.0 ⁽⁶⁾	144.0	170.0 ⁽⁶⁾	135.0	
	BW		256.0 ⁽⁶⁾		253.0 ⁽⁴⁾		245.0 ⁽³⁾	128.0	241.0 ⁽³⁾	141.0	235.0 ⁽²⁾	145.0	229.0 ⁽²⁾	137.0	
300	B		155.0 ⁽¹¹⁾		165.0 ⁽¹¹⁾		167.0 ⁽¹⁰⁾		162.0 ⁽⁹⁾	107.0	158.0 ⁽⁸⁾	119.0	148.0 ⁽⁶⁾	112.0	
	BW		234.0 ⁽⁸⁾		228.0 ⁽⁶⁾		220.0 ⁽⁴⁾		215.0 ⁽³⁾	105.0	207.0 ⁽³⁾	119.0	204.0 ⁽²⁾	119.0	
320	B		124.0 ⁽⁹⁾		136.0 ⁽¹¹⁾		141.0 ⁽¹¹⁾		145.0 ⁽¹⁰⁾		140.0 ⁽⁹⁾	83.6	132.0 ⁽⁸⁾	91.2	
	BW		206.0 ⁽⁹⁾		209.0 ⁽⁸⁾		200.0 ⁽⁶⁾		195.0 ⁽⁴⁾		186.0 ⁽³⁾	83.7	182.0 ⁽³⁾	94.8	
340	B		99.1 ⁽⁹⁾		107.0 ⁽⁹⁾		115.0 ⁽¹¹⁾		120.0 ⁽¹⁰⁾		124.0 ⁽¹⁰⁾		118.0 ⁽⁹⁾	65.2	
	BW		176.0 ⁽⁹⁾		182.0 ⁽⁹⁾		181.0 ⁽⁸⁾		175.0 ⁽⁵⁾		167.0 ⁽⁴⁾		163.0 ⁽⁴⁾	65.3	
360	B		75.3 ⁽⁷⁾		83.5 ⁽⁹⁾		89.0 ⁽⁹⁾		96.5 ⁽¹¹⁾		101.0 ⁽¹⁰⁾		104.0 ⁽¹⁰⁾	96.4 ⁽⁹⁾	
	BW		148.0 ⁽⁷⁾		155.0 ⁽⁹⁾		157.0 ⁽⁸⁾		157.0 ⁽⁸⁾		149.0 ⁽⁵⁾		145.0 ⁽⁴⁾	136.0 ⁽³⁾	
380	B				61.5 ⁽⁷⁾		67.1 ⁽⁹⁾		72.8 ⁽⁹⁾		79.5 ⁽¹¹⁾		82.4 ⁽¹⁰⁾	81.9 ⁽¹⁰⁾	
	BW				130.0 ⁽⁷⁾		134.0 ⁽⁹⁾		137.0 ⁽⁸⁾		129.0 ⁽⁹⁾		125.0 ⁽⁴⁾	117.0 ⁽⁴⁾	
400	B						46.2 ⁽⁷⁾		52.6 ⁽⁹⁾		56.2 ⁽⁹⁾		62.0 ⁽¹¹⁾	62.3 ⁽¹⁰⁾	
	BW						110.0 ⁽⁷⁾		117.0 ⁽⁹⁾		114.0 ⁽⁹⁾		110.0 ⁽⁹⁾	102.0 ⁽⁵⁾	
420	B								31.5 ⁽⁷⁾		36.6 ⁽⁹⁾		39.0 ⁽⁹⁾	44.1 ⁽¹¹⁾	
	BW								94.9 ⁽⁷⁾		98.1 ⁽⁹⁾		96.0 ⁽⁹⁾	88.1 ⁽⁶⁾	
440	B												20.7 ⁽⁹⁾		
	BW												82.4 ⁽⁹⁾	75.9 ⁽⁹⁾	
460	B														
	BW												62.5 ⁽⁷⁾	65.6 ⁽⁹⁾	
480	B														
	BW													46.9 ⁽⁷⁾	

1) 12° 2) 17° 3) 22° 4) 27° 5) 32° 6) 37° 7) 42° 8) 47° 9) 52° 10) 57° 11) 62°

PDW3B/PDW3BW

P 256

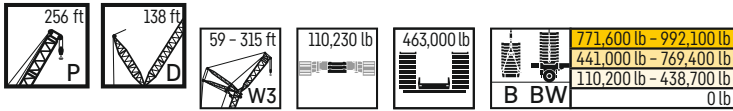

ft	B BW	P 256 ft													
		W3 59 ft		W3 79 ft		W3 98 ft		W3 118 ft		W3 138 ft		W3 158 ft		W3 177 ft	
		87°/85	WVmax	87°/85	WVmax	87°/85	WVmax	87°/85	WVmax	87°/85	WVmax	87°/85	WVmax	87°/85	WVmax
50	B	1121.0*	1129.0 ⁽²⁾	1044.0*	1044.0*										
	BW	1143.0*	1153.0 ⁽²⁾	1064.0*	1064.0*										
60	B	1129.0	1130.0 ⁽²⁾	966.0*	1007.0 ⁽²⁾	917.0*	951.0 ⁽¹⁾	854.0*	856.0 ⁽¹⁾						
	BW	1166.0	1167.0 ⁽²⁾	979.0*	1025.0 ⁽²⁾	935.0*	970.0 ⁽¹⁾	871.0*	874.0 ⁽¹⁾						
70	B	1035.0	1036.0 ⁽²⁾	988.0	991.0 ⁽²⁾	938.0	938.0	806.0*	863.0 ⁽¹⁾	756.0*	778.0 ⁽¹⁾	702.0*	703.0 ⁽¹⁾		
	BW	1047.0	1121.0 ⁽²⁾	1003.0	1020.0 ⁽²⁾	967.0	967.0	823.0*	880.0 ⁽¹⁾	770.0*	798.0 ⁽¹⁾	716.0*	716.0*		
80	B	843.0	944.0 ⁽⁴⁾	900.0	912.0 ⁽²⁾	873.0	874.0 ⁽¹⁾	828.0	828.0	775.0	775.0	665.0*	702.0 ⁽¹⁾	623.0*	623.0*
	BW	845.0	1077.0 ⁽²⁾	911.0	992.0 ⁽²⁾	912.0	939.0 ⁽¹⁾	857.0	867.0 ⁽¹⁾	802.0	802.0	684.0*	688.0 ⁽¹⁾	640.0*	640.0*
90	B	581.0	852.0 ⁽⁴⁾	761.0	833.0 ⁽²⁾	810.0	812.0 ⁽¹⁾	774.0	775.0 ⁽¹⁾	730.0	734.0 ⁽¹⁾	682.0	682.0	587.0*	589.0 ⁽²⁾
	BW	584.0	1024.0 ⁽²⁾	755.0	963.0 ⁽²⁾	850.0	912.0 ⁽¹⁾	808.0	849.0 ⁽¹⁾	760.0	772.0 ⁽¹⁾	709.0	709.0	606.0*	608.0 ⁽²⁾
100	B		766.0 ⁽⁴⁾	639.0	757.0 ⁽⁴⁾	754.0	754.0	720.0	724.0 ⁽¹⁾	684.0	694.0 ⁽¹⁾	643.0	644.0 ⁽²⁾	606.0	606.0
	BW		952.0 ⁽²⁾	636.0	921.0 ⁽²⁾	781.0	879.0 ⁽¹⁾	750.0	831.0 ⁽¹⁾	711.0	746.0 ⁽²⁾	671.0	679.0 ⁽²⁾	631.0	631.0
110	B		694.0 ⁽⁷⁾	462.0	686.0 ⁽⁴⁾	697.0	697.0	668.0	668.0	640.0	654.0 ⁽¹⁾	605.0	609.0 ⁽²⁾	572.0	576.0 ⁽²⁾
	BW		880.0 ⁽³⁾	460.0	859.0 ⁽³⁾	717.0	829.0 ⁽¹⁾	689.0	798.0 ⁽¹⁾	661.0	734.0 ⁽²⁾	629.0	674.0 ⁽²⁾	597.0	614.0 ⁽²⁾
120	B		627.0 ⁽⁸⁾		627.0 ⁽⁶⁾	592.0	639.0 ⁽⁸⁾	615.0	617.0 ⁽⁵⁾	595.0	613.0 ⁽¹⁾	568.0	575.0 ⁽²⁾	540.0	549.0 ⁽²⁾
	BW		809.0 ⁽⁴⁾		796.0 ⁽³⁾	595.0	778.0 ⁽¹⁾	637.0	754.0 ⁽¹⁾	613.0	722.0 ⁽²⁾	587.0	669.0 ⁽²⁾	562.0	612.0 ⁽²⁾
130	B		563.0 ⁽⁹⁾		574.0 ⁽⁸⁾	417.0	583.0 ⁽⁸⁾	574.0	574.0	553.0	573.0 ⁽¹⁾	530.0	540.0 ⁽²⁾	511.0	522.0 ⁽²⁾
	BW		720.0 ⁽⁸⁾		739.0 ⁽⁶⁾	417.0	737.0 ⁽⁶⁾	591.0	713.0 ⁽⁴⁾	569.0	688.0 ⁽²⁾	546.0	663.0 ⁽²⁾	526.0	610.0 ⁽²⁾
140	B				523.0 ⁽⁹⁾		527.0 ⁽⁹⁾	500.0	530.0 ⁽⁸⁾	515.0	533.0 ⁽¹⁾	493.0	511.0 ⁽¹⁾	480.0	496.0 ⁽²⁾
	BW				685.0 ⁽²⁾		687.0 ⁽⁶⁾	503.0	675.0 ⁽⁵⁾	529.0	652.0 ⁽³⁾	509.0	631.0 ⁽²⁾	492.0	608.0 ⁽²⁾
150	B				473.0 ⁽⁹⁾		486.0 ⁽¹⁰⁾	350.0	487.0 ⁽⁸⁾	477.0	492.0 ⁽¹⁾	460.0	484.0 ⁽¹⁾	449.0	459.0 ⁽³⁾
	BW				635.0 ⁽⁴⁾		635.0 ⁽⁷⁾	350.0	630.0 ⁽⁶⁾	485.0	616.0 ⁽⁴⁾	474.0	600.0 ⁽³⁾	460.0	578.0 ⁽²⁾
160	B				436.0 ⁽¹⁰⁾		445.0 ⁽¹⁰⁾		448.0 ⁽⁹⁾	420.0	452.0 ⁽¹⁾	432.0	457.0 ⁽¹⁾	421.0	428.0 ⁽⁴⁾
	BW				588.0 ⁽⁵⁾		586.0 ⁽⁷⁾		586.0 ⁽⁶⁾	419.0	575.0 ⁽⁴⁾	436.0	562.0 ⁽⁵⁾	426.0	547.0 ⁽²⁾
170	B				402.0 ⁽¹⁰⁾		404.0 ⁽¹¹⁾		415.0 ⁽¹¹⁾	296.0	417.0 ⁽⁹⁾	389.0	429.0 ⁽¹⁾	389.0	400.0 ⁽⁵⁾
	BW				541.0 ⁽⁵⁾		546.0 ⁽⁸⁾		542.0 ⁽⁶⁾	295.0	534.0 ⁽⁵⁾	389.0	525.0 ⁽³⁾	389.0	516.0 ⁽²⁾
180	B				367.0 ⁽¹⁰⁾		371.0 ⁽¹⁰⁾		381.0 ⁽¹¹⁾		388.0 ⁽¹⁰⁾	335.0	402.0 ⁽¹⁾	363.0	375.0 ⁽⁶⁾
	BW				495.0 ⁽⁶⁾		510.0 ⁽⁸⁾		505.0 ⁽⁷⁾		503.0 ⁽¹⁾	335.0	491.0 ⁽⁴⁾	362.0	486.0 ⁽²⁾
190	B				333.0 ⁽¹⁰⁾		341.0 ⁽¹⁰⁾		348.0 ⁽¹¹⁾		363.0 ⁽¹¹⁾		375.0 ⁽¹⁾	326.0	352.0 ⁽⁷⁾
	BW				456.0 ⁽⁸⁾		473.0 ⁽⁸⁾		475.0 ⁽⁹⁾		473.0 ⁽¹⁾		460.0 ⁽³⁾	325.0	457.0 ⁽²⁾
200	B				299.0 ⁽⁸⁾		311.0 ⁽¹⁰⁾		319.0 ⁽¹⁰⁾		333.0 ⁽¹¹⁾		348.0 ⁽¹⁾	282.0	330.0 ⁽⁸⁾
	BW				426.0 ⁽⁸⁾		437.0 ⁽⁹⁾		445.0 ⁽¹⁰⁾		444.0 ⁽¹⁾		432.0 ⁽⁴⁾	282.0	430.0 ⁽³⁾
220	B				253.0 ⁽⁸⁾		253.0 ⁽⁸⁾		268.0 ⁽¹⁰⁾		279.0 ⁽¹⁰⁾		293.0 ⁽¹⁾		295.0 ⁽¹⁰⁾
	BW				370.0 ⁽⁸⁾		370.0 ⁽⁸⁾		384.0 ⁽¹⁰⁾		388.0 ⁽⁹⁾		384.0 ⁽⁷⁾		380.0 ⁽⁵⁾
240	B						212.0 ⁽⁸⁾		218.0 ⁽⁸⁾		234.0 ⁽¹⁰⁾		240.0 ⁽¹⁰⁾		252.0 ⁽¹¹⁾
	BW						320.0 ⁽⁸⁾		325.0 ⁽⁹⁾		337.0 ⁽⁹⁾		337.0 ⁽⁷⁾		335.0 ⁽⁵⁾
260	B								182.0 ⁽⁸⁾		190.0 ⁽⁸⁾		201.0 ⁽¹⁰⁾		214.0 ⁽¹¹⁾
	BW								282.0 ⁽⁸⁾		288.0 ⁽⁸⁾		293.0 ⁽⁸⁾		292.0 ⁽⁴⁾
280	B										159.0 ⁽⁸⁾		161.0 ⁽⁸⁾		179.0 ⁽¹¹⁾
	BW										250.0 ⁽⁸⁾		254.0 ⁽⁸⁾		258.0 ⁽⁸⁾
300	B										126.0 ⁽⁶⁾		133.0 ⁽⁸⁾		143.0 ⁽⁹⁾
	BW										211.0 ⁽⁶⁾		219.0 ⁽⁸⁾		230.0 ⁽⁹⁾
320	B										101.0 ⁽⁶⁾		103.0 ⁽⁶⁾		117.0 ⁽⁹⁾
	BW										182.0 ⁽⁶⁾		184.0 ⁽⁶⁾		198.0 ⁽⁹⁾
340	B												80.6 ⁽⁶⁾		89.8 ⁽⁷⁾
	BW												157.0 ⁽⁶⁾		166.0 ⁽⁷⁾
360	B														69.1 ⁽⁷⁾
	BW														141.0 ⁽⁷⁾

1) 12° 2) 17° 3) 22° 4) 27° 5) 32° 6) 37° 7) 42° 8) 47° 9) 52° 10) 57° 11) 62°

PDW3B/PDW3BW

P 256

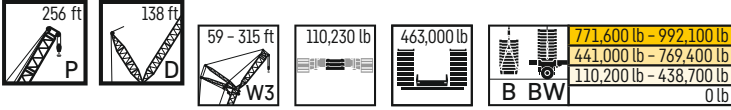

ft	B BW	P 256 ft													
		W3 197 ft		W3 217 ft		W3 236 ft		W3 256 ft		W3 276 ft		W3 295 ft		W3 315 ft	
		87°/85	WVmax	87°/85	WVmax	87°/85	WVmax	87°/85	WVmax	87°/85	WVmax	87°/85	WVmax	87°/85	WVmax
90	B	548.0*	548.0*	505.0*	505.0*										
	BW	565.0*	565.0*	521.0*	521.0*										
100	B	563.0	563.0	481.0*	481.0*	447.0*	447.0*	409.0*	409.0*						
	BW	583.0	583.0	499.0*	499.0*	459.0*	459.0*	417.0*	417.0*						
110	B	538.0	538.0	499.0	499.0	456.0	456.0	393.0*	393.0*	362.0*	362.0*	331.0*	331.0*		
	BW	559.0	559.0	515.0	515.0	467.0	467.0	405.0*	405.0*	370.0*	370.0*	337.0*	337.0*		
120	B	510.0	515.0 ⁽²⁾	476.0	476.0	442.0	442.0	404.0	404.0	347.0*	347.0*	320.0*	320.0*	292.0*	292.0*
	BW	531.0	552.0 ⁽²⁾	497.0	499.0 ⁽²⁾	457.0	457.0	415.0	415.0	359.0*	359.0*	329.0*	329.0*	298.0*	298.0*
130	B	482.0	494.0 ⁽²⁾	453.0	459.0 ⁽²⁾	422.0	424.0 ⁽²⁾	390.0	390.0	358.0	358.0	326.0	326.0	283.0*	283.0*
	BW	501.0	551.0 ⁽²⁾	474.0	496.0 ⁽²⁾	443.0	448.0 ⁽²⁾	405.0	405.0	368.0	368.0	334.0	334.0	291.0*	291.0*
140	B	455.0	472.0 ⁽²⁾	428.0	443.0 ⁽²⁾	402.0	412.0 ⁽²⁾	373.0	378.0 ⁽²⁾	346.0	346.0	319.0	319.0	289.0	289.0
	BW	470.0	550.0 ⁽²⁾	447.0	494.0 ⁽²⁾	423.0	445.0 ⁽²⁾	393.0	399.0 ⁽²⁾	359.0	359.0	328.0	328.0	296.0	296.0
150	B	429.0	450.0 ⁽²⁾	405.0	426.0 ⁽²⁾	382.0	399.0 ⁽²⁾	356.0	369.0 ⁽²⁾	333.0	338.0 ⁽²⁾	308.0	308.0	283.0	283.0
	BW	442.0	548.0 ⁽²⁾	421.0	493.0 ⁽²⁾	400.0	443.0 ⁽²⁾	378.0	397.0 ⁽²⁾	350.0	356.0 ⁽²⁾	321.0	321.0	291.0	291.0
160	B	403.0	418.0 ⁽³⁾	383.0	408.0 ⁽²⁾	362.0	387.0 ⁽²⁾	340.0	360.0 ⁽²⁾	318.0	332.0 ⁽²⁾	296.0	303.0 ⁽²⁾	274.0	275.0 ⁽²⁾
	BW	415.0	524.0 ⁽²⁾	397.0	488.0 ⁽²⁾	378.0	441.0 ⁽²⁾	358.0	395.0 ⁽²⁾	338.0	354.0 ⁽²⁾	312.0	319.0 ⁽²⁾	285.0	286.0 ⁽²⁾
170	B	377.0	391.0 ⁽³⁾	362.0	379.0 ⁽³⁾	343.0	370.0 ⁽²⁾	322.0	351.0 ⁽²⁾	303.0	326.0 ⁽²⁾	282.0	298.0 ⁽²⁾	264.0	273.0 ⁽²⁾
	BW	387.0	499.0 ⁽²⁾	373.0	471.0 ⁽²⁾	357.0	435.0 ⁽²⁾	340.0	392.0 ⁽²⁾	321.0	352.0 ⁽²⁾	301.0	317.0 ⁽²⁾	278.0	284.0 ⁽²⁾
180	B	353.0	367.0 ⁽⁴⁾	341.0	356.0 ⁽³⁾	325.0	344.0 ⁽³⁾	305.0	336.0 ⁽²⁾	289.0	320.0 ⁽²⁾	270.0	294.0 ⁽²⁾	252.0	270.0 ⁽²⁾
	BW	355.0	474.0 ⁽²⁾	347.0	453.0 ⁽²⁾	336.0	423.0 ⁽²⁾	322.0	388.0 ⁽²⁾	305.0	350.0 ⁽²⁾	287.0	315.0 ⁽²⁾	268.0	282.0 ⁽²⁾
190	B	330.0	345.0 ⁽⁵⁾	317.0	337.0 ⁽⁴⁾	307.0	325.0 ⁽³⁾	290.0	312.0 ⁽³⁾	274.0	305.0 ⁽²⁾	257.0	289.0 ⁽²⁾	239.0	267.0 ⁽²⁾
	BW	330.0	449.0 ⁽²⁾	318.0	435.0 ⁽²⁾	314.0	411.0 ⁽²⁾	302.0	380.0 ⁽²⁾	289.0	345.0 ⁽²⁾	273.0	314.0 ⁽²⁾	256.0	280.0 ⁽²⁾
200	B	299.0	323.0 ⁽⁶⁾	298.0	316.0 ⁽⁵⁾	288.0	308.0 ⁽⁴⁾	276.0	296.0 ⁽³⁾	260.0	283.0 ⁽³⁾	243.0	275.0 ⁽²⁾	228.0	264.0 ⁽²⁾
	BW	300.0	423.0 ⁽²⁾	298.0	415.0 ⁽²⁾	289.0	400.0 ⁽²⁾	283.0	372.0 ⁽²⁾	274.0	339.0 ⁽²⁾	259.0	308.0 ⁽²⁾	244.0	278.0 ⁽²⁾
220	B	228.0	287.0 ⁽⁸⁾	249.0	281.0 ⁽⁶⁾	252.0	274.0 ⁽⁵⁾	240.0	262.0 ⁽⁴⁾	233.0	253.0 ⁽⁴⁾	218.0	244.0 ⁽³⁾	206.0	231.0 ⁽³⁾
	BW	228.0	374.0 ⁽³⁾	249.0	368.0 ⁽²⁾	252.0	363.0 ⁽²⁾	241.0	354.0 ⁽²⁾	238.0	327.0 ⁽²⁾	232.0	297.0 ⁽²⁾	221.0	269.0 ⁽²⁾
240	B		253.0 ⁽⁹⁾	190.0	251.0 ⁽⁸⁾	209.0	244.0 ⁽⁷⁾	211.0	236.0 ⁽⁶⁾	204.0	227.0 ⁽⁵⁾	194.0	217.0 ⁽⁴⁾	185.0	205.0 ⁽³⁾
	BW		330.0 ⁽⁴⁾	190.0	326.0 ⁽³⁾	209.0	321.0 ⁽²⁾	213.0	316.0 ⁽²⁾	206.0	302.0 ⁽²⁾	197.0	284.0 ⁽²⁾	194.0	259.0 ⁽²⁾
260	B		216.0 ⁽¹⁰⁾		218.0 ⁽⁸⁾	159.0	218.0 ⁽⁸⁾	177.0	211.0 ⁽⁷⁾	176.0	205.0 ⁽⁶⁾	169.0	194.0 ⁽⁵⁾	165.0	183.0 ⁽⁴⁾
	BW		288.0 ⁽⁴⁾		284.0 ⁽³⁾	159.0	280.0 ⁽³⁾	176.0	277.0 ⁽²⁾	179.0	269.0 ⁽²⁾	169.0	256.0 ⁽²⁾	167.0	242.0 ⁽²⁾
280	B		186.0 ⁽¹¹⁾		188.0 ⁽¹⁰⁾		188.0 ⁽⁹⁾	132.0	185.0 ⁽⁸⁾	147.0	177.0 ⁽⁷⁾	141.0	171.0 ⁽⁶⁾	138.0	163.0 ⁽⁵⁾
	BW		254.0 ⁽⁶⁾		249.0 ⁽⁴⁾		244.0 ⁽³⁾	132.0	240.0 ⁽³⁾	147.0	236.0 ⁽²⁾	147.0	228.0 ⁽²⁾	141.0	218.0 ⁽²⁾
300	B		155.0 ⁽¹¹⁾		162.0 ⁽¹¹⁾		162.0 ⁽¹⁰⁾		161.0 ⁽⁹⁾	111.0	157.0 ⁽⁸⁾	118.0	147.0 ⁽⁷⁾	113.0	143.0 ⁽⁶⁾
	BW		227.0 ⁽⁸⁾		221.0 ⁽⁶⁾		216.0 ⁽⁴⁾		211.0 ⁽⁴⁾	111.0	207.0 ⁽³⁾	122.0	200.0 ⁽²⁾	121.0	194.0 ⁽²⁾
320	B		122.0 ⁽⁹⁾		133.0 ⁽¹¹⁾		139.0 ⁽¹¹⁾		140.0 ⁽¹⁰⁾		137.0 ⁽⁹⁾	87.3	130.0 ⁽⁹⁾	92.7	125.0 ⁽⁸⁾
	BW		203.0 ⁽⁹⁾		200.0 ⁽⁷⁾		193.0 ⁽⁶⁾		187.0 ⁽⁵⁾		182.0 ⁽⁴⁾	87.8	176.0 ⁽³⁾	98.5	171.0 ⁽³⁾
340	B		97.3 ⁽⁹⁾		103.0 ⁽⁹⁾		113.0 ⁽¹¹⁾		120.0 ⁽¹¹⁾		120.0 ⁽¹⁰⁾		113.0 ⁽⁹⁾	71.2	110.0 ⁽⁹⁾
	BW		174.0 ⁽⁹⁾		179.0 ⁽⁹⁾		176.0 ⁽⁷⁾		169.0 ⁽⁶⁾		163.0 ⁽⁵⁾		156.0 ⁽⁴⁾	71.2	152.0 ⁽³⁾
360	B		72.1 ⁽⁷⁾		80.8 ⁽⁹⁾		84.9 ⁽⁹⁾		95.1 ⁽¹¹⁾		101.0 ⁽¹¹⁾		98.9 ⁽¹⁰⁾		93.7 ⁽⁹⁾
	BW		145.0 ⁽⁷⁾		153.0 ⁽⁹⁾		157.0 ⁽⁹⁾		154.0 ⁽⁸⁾		148.0 ⁽⁶⁾		140.0 ⁽⁵⁾		135.0 ⁽⁴⁾
380	B		52.7 ⁽⁷⁾		56.6 ⁽⁷⁾		63.5 ⁽⁹⁾		67.5 ⁽⁹⁾		77.1 ⁽¹¹⁾		80.2 ⁽¹¹⁾		80.6 ⁽¹¹⁾
	BW		121.0 ⁽⁷⁾		126.0 ⁽⁷⁾		133.0 ⁽⁹⁾		137.0 ⁽⁹⁾		135.0 ⁽⁸⁾		127.0 ⁽⁶⁾		121.0 ⁽⁵⁾
400	B				38.2 ⁽⁷⁾		39.8 ⁽⁷⁾		47.5 ⁽⁹⁾		50.6 ⁽⁹⁾		58.6 ⁽¹¹⁾		63.9 ⁽¹¹⁾
	BW				104.0 ⁽⁷⁾		107.0 ⁽⁷⁾		115.0 ⁽⁹⁾		118.0 ⁽⁹⁾		115.0 ⁽⁸⁾		110.0 ⁽⁶⁾
420	B						22.5 ⁽⁷⁾				31.7 ⁽⁹⁾				43.0 ⁽¹¹⁾
	BW						87.1 ⁽⁷⁾			90.7 ⁽⁷⁾	97.1 ⁽⁹⁾		99.1 ⁽⁹⁾		93.0 ⁽⁷⁾
440	B														
	BW								72.1 ⁽⁷⁾		74.5 ⁽⁷⁾		79.9 ⁽⁹⁾		79.2 ⁽⁹⁾
460	B														
	BW										56.9 ⁽⁷⁾		58.7 ⁽⁷⁾		63.2 ⁽⁹⁾
480	B														
	BW												42.3 ⁽⁷⁾		44.3 ⁽⁷⁾
500	B														
	BW														28.5 ⁽⁷⁾

1) 12° 2) 17° 3) 22° 4) 27° 5) 32° 6) 37° 7) 42° 8) 47° 9) 52° 10) 57° 11) 62°

PDW3B/PDW3BW

P 276

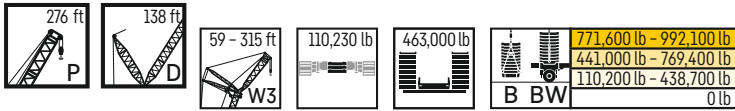

ft	B BW	P 276 ft													
		W3 59 ft		W3 79 ft		W3 98 ft		W3 118 ft		W3 138 ft		W3 158 ft		W3 177 ft	
		87°/85	WVmax	87°/85	WVmax	87°/85	WVmax	87°/85	WVmax	87°/85	WVmax	87°/85	WVmax	87°/85	WVmax
50	B	1051.0*	1051.0*												
	BW	1074.0*	1074.0*												
60	B	1069.0	1069.0	914.0*	939.0 ⁽²⁾	861.0*	887.0 ⁽¹⁾	802.0*	802.0*						
	BW	1098.0	1098.0	926.0*	954.0 ⁽²⁾	878.0*	906.0 ⁽¹⁾	819.0*	819.0*						
70	B	988.0	993.0 ⁽³⁾	939.0	940.0 ⁽²⁾	885.0	885.0	758.0*	806.0 ⁽¹⁾	712.0*	728.0 ⁽¹⁾	663.0*	663.0*		
	BW	998.0	1055.0 ⁽²⁾	946.0	952.0 ⁽²⁾	909.0	910.0 ⁽¹⁾	776.0*	827.0 ⁽¹⁾	727.0*	729.0 ⁽¹⁾	675.0*	675.0*		
80	B	876.0	913.0 ⁽²⁾	858.0	874.0 ⁽²⁾	830.0	831.0 ⁽¹⁾	780.0	783.0 ⁽¹⁾	731.0	731.0	627.0*	636.0 ⁽¹⁾	586.0*	586.0*
	BW	879.0	1022.0 ⁽²⁾	862.0	926.0 ⁽²⁾	861.0	890.0 ⁽¹⁾	808.0	821.0 ⁽¹⁾	698.0	704.0 ⁽¹⁾	646.0*	649.0 ⁽¹⁾	602.0*	602.0*
90	B	641.0	834.0 ⁽²⁾	775.0	807.0 ⁽²⁾	773.0	780.0 ⁽¹⁾	730.0	741.0 ⁽¹⁾	689.0	694.0 ⁽¹⁾	645.0	645.0	555.0*	555.0*
	BW	640.0	989.0 ⁽²⁾	779.0	901.0 ⁽²⁾	803.0	870.0 ⁽¹⁾	761.0	807.0 ⁽¹⁾	716.0	716.0	670.0	670.0	571.0*	571.0*
100	B		752.0 ⁽⁴⁾	662.0	741.0 ⁽²⁾	717.0	728.0 ⁽¹⁾	680.0	698.0 ⁽¹⁾	645.0	658.0 ⁽¹⁾	608.0	610.0 ⁽²⁾	573.0	573.0
	BW		929.0 ⁽⁴⁾	658.0	873.0 ⁽⁴⁾	737.0	850.0 ⁽¹⁾	704.0	793.0 ⁽¹⁾	671.0	704.0 ⁽²⁾	632.0	636.0 ⁽²⁾	594.0	594.0
110	B		683.0 ⁽⁷⁾	508.0	674.0 ⁽⁴⁾	660.0	664.0 ⁽²⁾	635.0	652.0 ⁽¹⁾	605.0	621.0 ⁽¹⁾	573.0	581.0 ⁽²⁾	543.0	546.0 ⁽²⁾
	BW		862.0 ⁽⁴⁾	506.0	822.0 ⁽²⁾	679.0	803.0 ⁽¹⁾	649.0	773.0 ⁽¹⁾	623.0	696.0 ⁽²⁾	594.0	632.0 ⁽²⁾	562.0	572.0 ⁽²⁾
120	B		622.0 ⁽⁹⁾		617.0 ⁽⁶⁾	600.0	612.0 ⁽⁸⁾	586.0	597.0 ⁽²⁾	565.0	585.0 ⁽¹⁾	538.0	552.0 ⁽²⁾	513.0	523.0 ⁽²⁾
	BW		796.0 ⁽⁵⁾		771.0 ⁽²⁾	611.0	756.0 ⁽¹⁾	601.0	732.0 ⁽¹⁾	580.0	689.0 ⁽²⁾	553.0	627.0 ⁽²⁾	528.0	569.0 ⁽²⁾
130	B		560.0 ⁽⁹⁾		566.0 ⁽⁸⁾	460.0	565.0 ⁽⁸⁾	544.0	550.0 ⁽⁵⁾	526.0	548.0 ⁽¹⁾	504.0	524.0 ⁽²⁾	483.0	500.0 ⁽²⁾
	BW		737.0 ⁽²⁾		721.0 ⁽²⁾	460.0	715.0 ⁽⁵⁾	562.0	690.0 ⁽³⁾	537.0	669.0 ⁽²⁾	515.0	623.0 ⁽²⁾	494.0	566.0 ⁽²⁾
140	B		502.0 ⁽⁷⁾		519.0 ⁽⁹⁾		519.0 ⁽⁸⁾	505.0	509.0 ⁽⁶⁾	491.0	511.0 ⁽¹⁾	471.0	489.0 ⁽²⁾	454.0	478.0 ⁽²⁾
	BW		682.0 ⁽⁴⁾		672.0 ⁽²⁾		672.0 ⁽⁷⁾	520.0	653.0 ⁽⁴⁾	500.0	631.0 ⁽²⁾	480.0	605.0 ⁽²⁾	462.0	562.0 ⁽²⁾
150	B		463.0 ⁽⁹⁾		471.0 ⁽¹⁰⁾		478.0 ⁽¹⁰⁾	390.0	475.0 ⁽⁹⁾	460.0	475.0 ⁽¹⁾	440.0	462.0 ⁽¹⁾	425.0	447.0 ⁽²⁾
	BW		631.0 ⁽⁸⁾		624.0 ⁽³⁾		627.0 ⁽⁸⁾	391.0	609.0 ⁽⁴⁾	472.0	593.0 ⁽³⁾	450.0	573.0 ⁽²⁾	433.0	546.0 ⁽²⁾
160	B		424.0 ⁽⁹⁾		428.0 ⁽¹⁰⁾		440.0 ⁽¹¹⁾		440.0 ⁽⁹⁾	423.0	438.0 ⁽¹⁾	414.0	437.0 ⁽¹⁾	398.0	419.0 ⁽³⁾
	BW		583.0 ⁽⁸⁾		581.0 ⁽⁶⁾		582.0 ⁽⁸⁾		568.0 ⁽⁵⁾	431.0	556.0 ⁽³⁾	424.0	542.0 ⁽²⁾	406.0	521.0 ⁽²⁾
170	B		385.0 ⁽⁹⁾		395.0 ⁽¹⁰⁾		401.0 ⁽¹¹⁾		409.0 ⁽¹⁰⁾	331.0	406.0 ⁽⁹⁾	387.0	412.0 ⁽¹⁾	374.0	393.0 ⁽⁴⁾
	BW		535.0 ⁽⁸⁾		539.0 ⁽⁶⁾		536.0 ⁽⁸⁾		531.0 ⁽⁸⁾	332.0	522.0 ⁽⁴⁾	392.0	510.0 ⁽²⁾	380.0	497.0 ⁽²⁾
180	B		346.0 ⁽⁹⁾		363.0 ⁽¹⁰⁾		362.0 ⁽¹⁰⁾		377.0 ⁽¹¹⁾		380.0 ⁽⁹⁾	348.0	387.0 ⁽¹⁾	354.0	368.0 ⁽⁵⁾
	BW		486.0 ⁽⁸⁾		497.0 ⁽⁷⁾		501.0 ⁽⁹⁾		498.0 ⁽⁸⁾		490.0 ⁽⁵⁾	347.0	480.0 ⁽²⁾	360.0	472.0 ⁽²⁾
190	B				331.0 ⁽¹⁰⁾		334.0 ⁽¹¹⁾		344.0 ⁽¹¹⁾		356.0 ⁽¹¹⁾	278.0	362.0 ⁽¹⁾	331.0	345.0 ⁽⁴⁾
	BW				458.0 ⁽⁷⁾		467.0 ⁽⁹⁾		465.0 ⁽⁹⁾		460.0 ⁽⁵⁾	278.0	452.0 ⁽³⁾	331.0	445.0 ⁽²⁾
200	B				298.0 ⁽¹⁰⁾		306.0 ⁽¹⁰⁾		312.0 ⁽¹⁰⁾		328.0 ⁽¹¹⁾		337.0 ⁽¹⁾	293.0	324.0 ⁽⁷⁾
	BW				420.0 ⁽⁹⁾		433.0 ⁽¹⁰⁾		436.0 ⁽⁹⁾		433.0 ⁽⁷⁾		425.0 ⁽⁵⁾	290.0	420.0 ⁽³⁾
220	B						250.0 ⁽¹⁰⁾		263.0 ⁽¹⁰⁾		272.0 ⁽¹⁰⁾		287.0 ⁽¹⁾		289.0 ⁽¹⁰⁾
	BW						367.0 ⁽¹⁰⁾		379.0 ⁽¹⁰⁾		384.0 ⁽¹⁰⁾		378.0 ⁽⁷⁾		372.0 ⁽⁵⁾
240	B						206.0 ⁽⁸⁾		215.0 ⁽¹⁰⁾		230.0 ⁽¹⁰⁾		237.0 ⁽¹⁾		251.0 ⁽¹¹⁾
	BW						314.0 ⁽⁸⁾		322.0 ⁽¹⁰⁾		335.0 ⁽¹⁰⁾		336.0 ⁽⁸⁾		332.0 ⁽⁶⁾
260	B						169.0 ⁽⁸⁾		176.0 ⁽⁸⁾		188.0 ⁽¹⁰⁾		198.0 ⁽¹⁰⁾		211.0 ⁽¹¹⁾
	BW						268.0 ⁽⁸⁾		276.0 ⁽⁸⁾		287.0 ⁽¹⁰⁾		293.0 ⁽⁹⁾		293.0 ⁽⁷⁾
280	B								143.0 ⁽⁸⁾		153.0 ⁽⁸⁾		161.0 ⁽¹⁰⁾		177.0 ⁽¹¹⁾
	BW								235.0 ⁽⁸⁾		245.0 ⁽⁸⁾		252.0 ⁽¹⁰⁾		256.0 ⁽⁸⁾
300	B										123.0 ⁽⁸⁾		129.0 ⁽⁸⁾		143.0 ⁽¹¹⁾
	BW										209.0 ⁽⁸⁾		215.0 ⁽⁸⁾		224.0 ⁽¹⁰⁾
320	B										95.4 ⁽⁶⁾		102.0 ⁽⁸⁾		114.0 ⁽⁹⁾
	BW										177.0 ⁽⁶⁾		183.0 ⁽⁸⁾		193.0 ⁽⁹⁾
340	B										72.6 ⁽⁶⁾				88.0 ⁽⁹⁾
	BW										149.0 ⁽⁶⁾				163.0 ⁽⁹⁾
360	B														64.5 ⁽⁷⁾
	BW														136.0 ⁽⁷⁾
380	B														44.6 ⁽⁷⁾
	BW														112.0 ⁽⁷⁾

1) 12° 2) 17° 3) 22° 4) 27° 5) 32° 6) 37° 7) 42° 8) 47° 9) 52° 10) 57° 11) 62°

PDW3B/PDW3BW

P 276

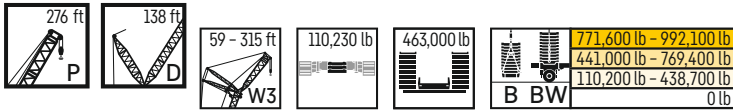

ft	B BW	P 276 ft													
		W3 197 ft		W3 217 ft		W3 236 ft		W3 256 ft		W3 276 ft		W3 295 ft		W3 315 ft	
		87°/85	WVmax	87°/85	WVmax	87°/85	WVmax	87°/85	WVmax	87°/85	WVmax	87°/85	WVmax	87°/85	WVmax
90	B	516.0*	516.0*	480.0*	480.0*										
	BW	532.0*	532.0*	493.0*	493.0*										
100	B	531.0	531.0	456.0*	456.0*	423.0*	423.0*	391.0*	391.0*						
	BW	552.0	552.0	473.0*	473.0*	436.0*	436.0*	399.0*	399.0*						
110	B	506.0	506.0	473.0	473.0	434.0	434.0	375.0*	375.0*	343.0*	343.0*	314.0*	314.0*		
	BW	526.0	526.0	492.0	492.0	447.0	447.0	387.0*	387.0*	353.0*	353.0*	322.0*	322.0*		
120	B	481.0	486.0 ⁽²⁾	451.0	451.0	418.0	418.0	387.0	387.0	329.0*	329.0*	303.0*	303.0*	279.0*	279.0*
	BW	498.0	515.0 ⁽²⁾	471.0	471.0	435.0	435.0	398.0	398.0	340.0*	340.0*	313.0*	313.0*	285.0*	285.0*
130	B	455.0	467.0 ⁽²⁾	429.0	436.0 ⁽²⁾	399.0	399.0	373.0	373.0	341.0	341.0	312.0	312.0	268.0*	268.0*
	BW	470.0	512.0 ⁽²⁾	447.0	466.0 ⁽²⁾	417.0	419.0 ⁽²⁾	389.0	389.0	352.0	352.0	320.0	320.0	277.0*	277.0*
140	B	429.0	449.0 ⁽²⁾	408.0	422.0 ⁽²⁾	379.0	388.0 ⁽²⁾	357.0	358.0 ⁽²⁾	328.0	328.0	303.0	303.0	277.0	277.0
	BW	441.0	509.0 ⁽²⁾	421.0	464.0 ⁽²⁾	397.0	417.0 ⁽²⁾	374.0	380.0 ⁽²⁾	344.0	344.0	314.0	314.0	284.0	284.0
150	B	405.0	430.0 ⁽²⁾	385.0	408.0 ⁽²⁾	360.0	377.0 ⁽²⁾	339.0	351.0 ⁽²⁾	314.0	318.0 ⁽²⁾	290.0	290.0	269.0	269.0
	BW	414.0	507.0 ⁽²⁾	397.0	462.0 ⁽²⁾	375.0	415.0 ⁽²⁾	356.0	378.0 ⁽²⁾	332.0	339.0 ⁽²⁾	307.0	307.0	279.0	279.0
160	B	380.0	402.0 ⁽²⁾	364.0	394.0 ⁽²⁾	342.0	367.0 ⁽²⁾	323.0	343.0 ⁽²⁾	300.0	312.0 ⁽²⁾	278.0	284.0 ⁽²⁾	258.0	259.0 ⁽²⁾
	BW	388.0	492.0 ⁽²⁾	374.0	460.0 ⁽²⁾	354.0	413.0 ⁽²⁾	338.0	375.0 ⁽²⁾	317.0	337.0 ⁽²⁾	294.0	303.0 ⁽²⁾	272.0	273.0 ⁽²⁾
170	B	357.0	378.0 ⁽³⁾	344.0	367.0 ⁽²⁾	324.0	356.0 ⁽²⁾	308.0	335.0 ⁽²⁾	285.0	307.0 ⁽²⁾	266.0	280.0 ⁽²⁾	247.0	256.0 ⁽²⁾
	BW	365.0	474.0 ⁽²⁾	352.0	447.0 ⁽²⁾	334.0	410.0 ⁽²⁾	320.0	373.0 ⁽²⁾	300.0	334.0 ⁽²⁾	282.0	301.0 ⁽²⁾	263.0	271.0 ⁽²⁾
180	B	337.0	356.0 ⁽⁴⁾	324.0	347.0 ⁽³⁾	306.0	330.0 ⁽²⁾	292.0	327.0 ⁽²⁾	271.0	302.0 ⁽²⁾	252.0	276.0 ⁽²⁾	237.0	253.0 ⁽²⁾
	BW	343.0	455.0 ⁽²⁾	331.0	433.0 ⁽²⁾	316.0	401.0 ⁽²⁾	302.0	370.0 ⁽²⁾	284.0	332.0 ⁽²⁾	268.0	299.0 ⁽²⁾	252.0	269.0 ⁽²⁾
190	B	318.0	334.0 ⁽⁵⁾	306.0	326.0 ⁽⁴⁾	290.0	314.0 ⁽³⁾	276.0	303.0 ⁽²⁾	258.0	294.0 ⁽²⁾	240.0	272.0 ⁽²⁾	226.0	251.0 ⁽²⁾
	BW	326.0	436.0 ⁽²⁾	312.0	419.0 ⁽²⁾	298.0	391.0 ⁽²⁾	286.0	363.0 ⁽²⁾	270.0	328.0 ⁽²⁾	254.0	296.0 ⁽²⁾	239.0	267.0 ⁽²⁾
200	B	296.0	314.0 ⁽⁶⁾	288.0	306.0 ⁽⁵⁾	274.0	293.0 ⁽⁴⁾	262.0	289.0 ⁽³⁾	244.0	272.0 ⁽²⁾	227.0	264.0 ⁽²⁾	213.0	248.0 ⁽²⁾
	BW	303.0	412.0 ⁽²⁾	296.0	405.0 ⁽²⁾	280.0	381.0 ⁽²⁾	270.0	356.0 ⁽²⁾	255.0	323.0 ⁽²⁾	240.0	293.0 ⁽²⁾	228.0	265.0 ⁽²⁾
220	B	235.0	280.0 ⁽⁷⁾	253.0	276.0 ⁽⁶⁾	244.0	264.0 ⁽⁵⁾	235.0	256.0 ⁽⁴⁾	219.0	240.0 ⁽³⁾	204.0	234.0 ⁽³⁾	192.0	221.0 ⁽²⁾
	BW	235.0	366.0 ⁽⁴⁾	257.0	363.0 ⁽³⁾	251.0	353.0 ⁽²⁾	241.0	342.0 ⁽²⁾	228.0	311.0 ⁽²⁾	216.0	283.0 ⁽²⁾	204.0	257.0 ⁽²⁾
240	B		249.0 ⁽⁹⁾	200.0	246.0 ⁽⁸⁾	211.0	234.0 ⁽⁶⁾	207.0	227.0 ⁽⁵⁾	195.0	215.0 ⁽⁵⁾	184.0	208.0 ⁽⁴⁾	173.0	196.0 ⁽³⁾
	BW		327.0 ⁽⁵⁾	198.0	323.0 ⁽⁴⁾	213.0	315.0 ⁽³⁾	217.0	310.0 ⁽³⁾	204.0	292.0 ⁽²⁾	192.0	272.0 ⁽²⁾	182.0	247.0 ⁽²⁾
260	B		214.0 ⁽¹⁰⁾		218.0 ⁽¹⁰⁾	165.0	214.0 ⁽⁸⁾	180.0	207.0 ⁽⁷⁾	170.0	195.0 ⁽⁶⁾	164.0	186.0 ⁽⁵⁾	154.0	175.0 ⁽⁴⁾
	BW		288.0 ⁽⁵⁾		286.0 ⁽⁴⁾	165.0	278.0 ⁽³⁾	183.0	277.0 ⁽³⁾	181.0	265.0 ⁽³⁾	170.0	248.0 ⁽²⁾	163.0	233.0 ⁽²⁾
280	B		182.0 ⁽¹¹⁾		187.0 ⁽¹⁰⁾		187.0 ⁽⁹⁾	139.0	166.0 ⁽⁸⁾	144.0	177.0 ⁽⁷⁾	137.0	168.0 ⁽⁶⁾	135.0	156.0 ⁽⁵⁾
	BW		252.0 ⁽⁶⁾		251.0 ⁽⁵⁾		245.0 ⁽⁴⁾	139.0	244.0 ⁽³⁾	150.0	236.0 ⁽³⁾	146.0	223.0 ⁽³⁾	143.0	214.0 ⁽³⁾
300	B		151.0 ⁽¹¹⁾		159.0 ⁽¹¹⁾		159.0 ⁽¹⁰⁾		162.0 ⁽⁹⁾	115.0	156.0 ⁽⁸⁾	116.0	147.0 ⁽⁷⁾	110.0	139.0 ⁽⁶⁾
	BW		223.0 ⁽⁸⁾		220.0 ⁽⁶⁾		213.0 ⁽⁵⁾		212.0 ⁽⁴⁾	115.0	207.0 ⁽³⁾	123.0	198.0 ⁽³⁾	118.0	192.0 ⁽³⁾
320	B		120.0 ⁽¹¹⁾		131.0 ⁽¹¹⁾		135.0 ⁽¹¹⁾		137.0 ⁽¹⁰⁾		134.0 ⁽⁹⁾	91.0	131.0 ⁽⁹⁾	90.5	125.0 ⁽⁸⁾
	BW		197.0 ⁽¹⁰⁾		196.0 ⁽⁸⁾		188.0 ⁽⁶⁾		186.0 ⁽⁵⁾		180.0 ⁽⁴⁾	90.6	173.0 ⁽³⁾	97.9	170.0 ⁽³⁾
340	B		92.7 ⁽⁹⁾		103.0 ⁽¹¹⁾		109.0 ⁽¹¹⁾		117.0 ⁽¹¹⁾		113.0 ⁽¹⁰⁾		111.0 ⁽¹⁰⁾	73.0	113.0 ⁽⁹⁾
	BW		169.0 ⁽⁹⁾		175.0 ⁽¹⁰⁾		169.0 ⁽⁸⁾		165.0 ⁽⁶⁾		158.0 ⁽⁵⁾		152.0 ⁽⁴⁾	73.8	147.0 ⁽³⁾
360	B		68.9 ⁽⁹⁾		76.7 ⁽⁹⁾		82.7 ⁽¹¹⁾		92.3 ⁽¹¹⁾		95.4 ⁽¹¹⁾		92.3 ⁽¹¹⁾		91.8 ⁽¹⁰⁾
	BW		142.0 ⁽⁹⁾		150.0 ⁽⁹⁾		152.0 ⁽¹⁰⁾		148.0 ⁽⁷⁾		140.0 ⁽⁶⁾		133.0 ⁽⁵⁾		129.0 ⁽⁴⁾
380	B		45.6 ⁽⁷⁾		54.4 ⁽⁹⁾		56.9 ⁽⁹⁾		67.5 ⁽¹¹⁾		72.2 ⁽¹¹⁾		75.7 ⁽¹¹⁾		74.6 ⁽¹¹⁾
	BW		116.0 ⁽⁷⁾		125.0 ⁽⁹⁾		128.0 ⁽⁹⁾		135.0 ⁽¹⁰⁾		127.0 ⁽⁷⁾		119.0 ⁽⁶⁾		114.0 ⁽⁵⁾
400	B		26.9 ⁽⁷⁾		32.3 ⁽⁷⁾		36.2 ⁽⁹⁾		43.1 ⁽⁹⁾		48.9 ⁽¹¹⁾		54.0 ⁽¹¹⁾		58.7 ⁽¹¹⁾
	BW		94.4 ⁽⁷⁾		101.0 ⁽⁷⁾		105.0 ⁽⁹⁾		112.0 ⁽⁹⁾		115.0 ⁽¹⁰⁾		107.0 ⁽⁷⁾		101.0 ⁽⁶⁾
420	B				14.7 ⁽⁷⁾				23.6 ⁽⁹⁾				32.2 ⁽¹¹⁾		38.2 ⁽¹¹⁾
	BW				80.3 ⁽⁷⁾			82.2 ⁽⁷⁾	90.3 ⁽⁹⁾		93.4 ⁽⁹⁾		96.9 ⁽¹⁰⁾		90.7 ⁽⁷⁾
440	B														17.7 ⁽¹¹⁾
	BW						63.2 ⁽⁷⁾		68.8 ⁽⁷⁾		72.9 ⁽⁹⁾		76.5 ⁽⁹⁾		81.0 ⁽¹⁰⁾
460	B														
	BW							50.8 ⁽⁷⁾		52.5 ⁽⁷⁾		57.3 ⁽⁹⁾			61.5 ⁽⁹⁾
480	B														
	BW									35.7 ⁽⁷⁾		37.7 ⁽⁷⁾			43.4 ⁽⁹⁾
500	B														
	BW											22.0 ⁽⁷⁾			16.8 ⁽⁴⁾

1) 12° 2) 17° 3) 22° 4) 27° 5) 32° 6) 37° 7) 42° 8) 47° 9) 52° 10) 57° 11) 62°

PDW3B/PDW3BW

P 295

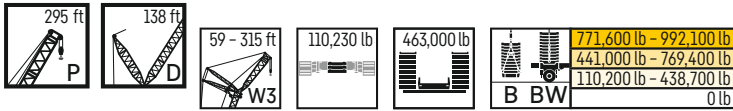

ft	B BW	P 295 ft													
		W3 59 ft		W3 79 ft		W3 98 ft		W3 118 ft		W3 138 ft		W3 158 ft		W3 177 ft	
		87*/85	WVmax	87*/85	WVmax	87*/85	WVmax	87*/85	WVmax	87*/85	WVmax	87*/85	WVmax	87*/85	WVmax
50	B	971.0*	971.0*												
50	BW	991.0*	991.0*												
60	B	989.0	989.0	845.0*	859.0 ⁽²⁾	793.0*	810.0 ⁽¹⁾	738.0*	738.0*						
60	BW	1016.0	1016.0	857.0*	872.0 ⁽²⁾	808.0*	827.0 ⁽¹⁾	750.0*	750.0*						
70	B	926.0	926.0	869.0	869.0	815.0	815.0	700.0*	733.0 ⁽¹⁾	655.0*	665.0 ⁽¹⁾	606.0*	606.0*		
70	BW	930.0	975.0 ⁽²⁾	879.0	879.0	838.0	838.0	714.0*	753.0 ⁽¹⁾	668.0*	669.0 ⁽¹⁾				
80	B	844.0	867.0 ⁽²⁾	811.0	816.0 ⁽²⁾	766.0	777.0 ⁽¹⁾	717.0	721.0 ⁽¹⁾	670.0*	670.0*	573.0*	598.0 ⁽¹⁾	536.0*	536.0*
80	BW	848.0	950.0 ⁽²⁾	805.0	860.0 ⁽²⁾	798.0	824.0 ⁽¹⁾	745.0	754.0 ⁽¹⁾	635.0*	649.0 ⁽¹⁾	590.0*	590.0*	550.0*	550.0*
90	B	694.0	808.0 ⁽²⁾	738.0	767.0 ⁽²⁾	714.0	739.0 ⁽¹⁾	671.0	691.0 ⁽¹⁾	633.0	637.0 ⁽¹⁾	589.0	589.0	508.0*	508.0*
90	BW	694.0	926.0 ⁽²⁾	734.0	847.0 ⁽²⁾	745.0	813.0 ⁽¹⁾	704.0	750.0 ⁽¹⁾	660.0	660.0	612.0	612.0	524.0*	524.0*
100	B		739.0 ⁽²⁾	662.0	719.0 ⁽²⁾	663.0	702.0 ⁽¹⁾	629.0	661.0 ⁽¹⁾	595.0	605.0 ⁽¹⁾	556.0	558.0 ⁽¹⁾	524.0	524.0
100	BW		883.0 ⁽²⁾	673.0	835.0 ⁽²⁾	686.0	803.0 ⁽¹⁾	652.0	745.0 ⁽¹⁾	620.0	645.0 ⁽¹⁾	581.0	581.0	545.0	545.0
110	B		672.0 ⁽⁶⁾	545.0	659.0 ⁽³⁾	608.0	650.0 ⁽¹⁾	587.0	631.0 ⁽¹⁾	559.0	579.0 ⁽²⁾	525.0	536.0 ⁽²⁾	497.0	499.0 ⁽²⁾
110	BW		830.0 ⁽⁶⁾	544.0	797.0 ⁽²⁾	633.0	773.0 ⁽¹⁾	603.0	740.0 ⁽¹⁾	577.0	644.0 ⁽²⁾	545.0	577.0 ⁽²⁾	516.0	523.0 ⁽²⁾
120	B		614.0 ⁽¹⁰⁾		603.0 ⁽⁵⁾	551.0	595.0 ⁽³⁾	543.0	583.0 ⁽²⁾	523.0	554.0 ⁽²⁾	494.0	515.0 ⁽²⁾	470.0	483.0 ⁽²⁾
120	BW		775.0 ⁽²⁾		751.0 ⁽⁴⁾	590.0	732.0 ⁽³⁾	559.0	706.0 ⁽¹⁾	538.0	642.0 ⁽²⁾	508.0	576.0 ⁽²⁾	486.0	522.0 ⁽²⁾
130	B		557.0 ⁽¹⁰⁾		554.0 ⁽⁷⁾	494.0	547.0 ⁽⁴⁾	494.0	538.0 ⁽³⁾	488.0	527.0 ⁽²⁾	466.0	495.0 ⁽²⁾	444.0	468.0 ⁽²⁾
130	BW		720.0 ⁽⁶⁾		704.0 ⁽²⁾	495.0	691.0 ⁽⁴⁾	523.0	670.0 ⁽³⁾	500.0	638.0 ⁽²⁾	475.0	575.0 ⁽²⁾	456.0	522.0 ⁽²⁾
140	B		501.0 ⁽¹⁰⁾		513.0 ⁽¹⁰⁾		506.0 ⁽⁶⁾	460.0	497.0 ⁽⁴⁾	451.0	490.0 ⁽³⁾	436.0	472.0 ⁽²⁾	419.0	452.0 ⁽²⁾
140	BW		664.0 ⁽⁸⁾		658.0 ⁽²⁾		659.0 ⁽⁶⁾	488.0	637.0 ⁽⁴⁾	466.0	607.0 ⁽³⁾	445.0	571.0 ⁽²⁾	427.0	522.0 ⁽²⁾
150	B				468.0 ⁽¹⁰⁾		469.0 ⁽⁸⁾	414.0	460.0 ⁽⁵⁾	415.0	456.0 ⁽⁴⁾	406.0	440.0 ⁽³⁾	395.0	432.0 ⁽²⁾
150	BW				613.0 ⁽³⁾		620.0 ⁽⁷⁾	419.0	597.0 ⁽⁵⁾	438.0	575.0 ⁽³⁾	415.0	546.0 ⁽²⁾	401.0	516.0 ⁽²⁾
160	B				423.0 ⁽¹¹⁾		436.0 ⁽¹¹⁾		429.0 ⁽⁷⁾	390.0	424.0 ⁽⁵⁾	373.0	411.0 ⁽⁴⁾	369.0	404.0 ⁽³⁾
160	BW				571.0 ⁽⁶⁾		575.0 ⁽⁸⁾		559.0 ⁽⁶⁾	412.0	542.0 ⁽⁴⁾	392.0	520.0 ⁽²⁾	377.0	497.0 ⁽²⁾
170	B				387.0 ⁽¹⁰⁾		398.0 ⁽¹¹⁾		402.0 ⁽⁹⁾	355.0	395.0 ⁽⁶⁾	349.0	385.0 ⁽⁵⁾	346.0	377.0 ⁽⁴⁾
170	BW				533.0 ⁽⁸⁾		532.0 ⁽⁸⁾		527.0 ⁽⁸⁾	359.0	511.0 ⁽⁴⁾	368.0	495.0 ⁽²⁾	353.0	478.0 ⁽²⁾
180	B				357.0 ⁽¹⁰⁾		360.0 ⁽¹¹⁾		374.0 ⁽¹¹⁾		373.0 ⁽⁸⁾	331.0	362.0 ⁽⁶⁾	322.0	353.0 ⁽⁵⁾
180	BW				496.0 ⁽⁸⁾		493.0 ⁽⁹⁾		493.0 ⁽⁸⁾		481.0 ⁽⁵⁾	343.0	469.0 ⁽²⁾	334.0	458.0 ⁽²⁾
190	B				326.0 ⁽¹⁰⁾		329.0 ⁽¹⁰⁾		342.0 ⁽¹¹⁾		349.0 ⁽¹⁰⁾	295.0	340.0 ⁽⁷⁾	301.0	333.0 ⁽⁵⁾
190	BW				459.0 ⁽⁸⁾		461.0 ⁽⁹⁾		461.0 ⁽⁹⁾		453.0 ⁽⁶⁾	295.0	441.0 ⁽³⁾	315.0	437.0 ⁽²⁾
200	B				296.0 ⁽¹⁰⁾		302.0 ⁽¹⁰⁾		310.0 ⁽¹¹⁾		326.0 ⁽¹¹⁾		319.0 ⁽⁸⁾	285.0	315.0 ⁽⁶⁾
200	BW				422.0 ⁽⁹⁾		430.0 ⁽¹⁰⁾		430.0 ⁽¹⁰⁾		427.0 ⁽⁸⁾		415.0 ⁽⁴⁾	294.0	412.0 ⁽³⁾
220	B						250.0 ⁽¹⁰⁾		260.0 ⁽¹⁰⁾		271.0 ⁽¹¹⁾		280.0 ⁽¹¹⁾		282.0 ⁽⁹⁾
220	BW						366.0 ⁽¹⁰⁾		376.0 ⁽¹⁰⁾		380.0 ⁽¹⁰⁾		370.0 ⁽⁶⁾		368.0 ⁽⁵⁾
240	B						201.0 ⁽⁸⁾		215.0 ⁽¹⁰⁾		227.0 ⁽¹⁰⁾		233.0 ⁽¹¹⁾		248.0 ⁽¹¹⁾
240	BW						308.0 ⁽⁸⁾		322.0 ⁽¹⁰⁾		333.0 ⁽¹⁰⁾		332.0 ⁽¹⁰⁾		330.0 ⁽⁷⁾
260	B						166.0 ⁽⁸⁾		172.0 ⁽⁸⁾		187.0 ⁽¹⁰⁾		194.0 ⁽¹⁰⁾		207.0 ⁽¹¹⁾
260	BW						266.0 ⁽⁸⁾		271.0 ⁽⁸⁾		292.0 ⁽¹¹⁾		291.0 ⁽¹⁰⁾		295.0 ⁽⁹⁾
280	B								140.0 ⁽⁸⁾		149.0 ⁽⁸⁾		158.0 ⁽¹⁰⁾		173.0 ⁽¹¹⁾
280	BW								233.0 ⁽⁸⁾		252.0 ⁽¹¹⁾		250.0 ⁽¹⁰⁾		258.0 ⁽⁹⁾
300	B										121.0 ⁽⁸⁾		123.0 ⁽⁸⁾		141.0 ⁽¹¹⁾
300	BW										212.0 ⁽¹¹⁾		209.0 ⁽⁸⁾		222.0 ⁽¹⁰⁾
320	B										90.2 ⁽⁶⁾		96.7 ⁽⁸⁾		108.0 ⁽⁹⁾
320	BW										172.0 ⁽¹¹⁾		177.0 ⁽⁸⁾		190.0 ⁽⁹⁾
340	B										68.6 ⁽⁶⁾				83.2 ⁽⁹⁾
340	BW										145.0 ⁽⁶⁾				160.0 ⁽⁹⁾
360	B														56.6 ⁽⁷⁾
360	BW														128.0 ⁽⁷⁾
380	B														37.6 ⁽⁷⁾
380	BW														106.0 ⁽⁷⁾

1) 12° 2) 17° 3) 22° 4) 27° 5) 32° 6) 37° 7) 42° 8) 47° 9) 52° 10) 57° 11) 62°

PDW3B/PDW3BW

P 295

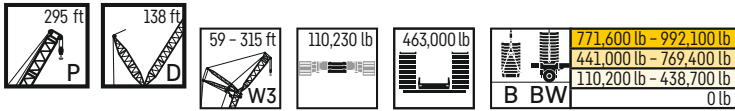

ft	P 295 ft														
	W3 197 ft		W3 217 ft		W3 236 ft		W3 256 ft		W3 276 ft		W3 295 ft		W3 315 ft		
	87°/85	WVmax	87°/85	WVmax	87°/85	WVmax	87°/85	WVmax	87°/85	WVmax	87°/85	WVmax	87°/85	WVmax	
80	B	436.0*	436.0*												
	BW														
90	B	472.0*	472.0*	438.0*	438.0*	348.0*	348.0*								
	BW	487.0*	487.0*	449.0*	449.0*										
100	B	486.0	486.0	417.0*	417.0*	386.0*	386.0*	355.0*	355.0*	273.0*	273.0*				
	BW	498.0	498.0	430.0*	430.0*	394.0*	394.0*	364.0*	364.0*						
110	B	464.0	464.0	431.0	431.0	369.0*	369.0*	340.0*	340.0*	310.0*	310.0*	288.0*	288.0*		
	BW	483.0	483.0	448.0	448.0	378.0*	378.0*	350.0*	350.0*	319.0*	319.0*	294.0*	294.0*		
120	B	441.0	444.0 ⁽²⁾	412.0	412.0	382.0	382.0	351.0	351.0	297.0*	297.0*	277.0*	277.0*	251.0*	251.0*
	BW	459.0	471.0 ⁽²⁾	430.0	430.0	396.0	396.0	366.0	366.0	306.0*	306.0*	285.0*	285.0*	257.0*	257.0*
130	B	418.0	433.0 ⁽²⁾	392.0	397.0 ⁽²⁾	367.0	367.0	338.0	338.0	308.0	308.0	286.0	286.0	241.0*	241.0*
	BW	433.0	472.0 ⁽²⁾	408.0	425.0 ⁽²⁾	381.0	381.0	355.0	355.0	323.0	323.0	295.0	295.0	248.0*	248.0*
140	B	395.0	421.0 ⁽²⁾	374.0	388.0 ⁽²⁾	349.0	357.0 ⁽²⁾	324.0	324.0	296.0	296.0	277.0	277.0	250.0	250.0
	BW	408.0	472.0 ⁽²⁾	386.0	425.0 ⁽²⁾	362.0	380.0 ⁽²⁾	340.0	344.0 ⁽²⁾	312.0	312.0	289.0	289.0	259.0	259.0
150	B	373.0	410.0 ⁽²⁾	350.0	380.0 ⁽²⁾	333.0	351.0 ⁽²⁾	309.0	320.0 ⁽²⁾	285.0	287.0 ⁽²⁾	266.0	266.0	241.0	241.0
	BW	383.0	473.0 ⁽²⁾	364.0	425.0 ⁽²⁾	343.0	381.0 ⁽²⁾	324.0	344.0 ⁽²⁾	300.0	306.0 ⁽²⁾	280.0	280.0	253.0	253.0
160	B	353.0	391.0 ⁽²⁾	332.0	372.0 ⁽²⁾	316.0	345.0 ⁽²⁾	296.0	316.0 ⁽²⁾	272.0	285.0 ⁽²⁾	255.0	260.0 ⁽²⁾	233.0	233.0
	BW	359.0	465.0 ⁽²⁾	343.0	426.0 ⁽²⁾	323.0	381.0 ⁽²⁾	307.0	344.0 ⁽²⁾	287.0	306.0 ⁽²⁾	270.0	278.0 ⁽²⁾	246.0	246.0
170	B	334.0	367.0 ⁽³⁾	315.0	354.0 ⁽²⁾	297.0	340.0 ⁽²⁾	282.0	313.0 ⁽²⁾	260.0	283.0 ⁽²⁾	244.0	259.0 ⁽²⁾	224.0	230.0 ⁽²⁾
	BW	338.0	451.0 ⁽²⁾	323.0	419.0 ⁽²⁾	305.0	382.0 ⁽²⁾	291.0	344.0 ⁽²⁾	273.0	305.0 ⁽²⁾	259.0	277.0 ⁽²⁾	237.0	245.0 ⁽²⁾
180	B	315.0	342.0 ⁽⁴⁾	298.0	333.0 ⁽³⁾	282.0	322.0 ⁽²⁾	266.0	309.0 ⁽²⁾	247.0	281.0 ⁽²⁾	233.0	258.0 ⁽²⁾	214.0	229.0 ⁽²⁾
	BW	319.0	436.0 ⁽²⁾	304.0	409.0 ⁽²⁾	288.0	377.0 ⁽²⁾	275.0	344.0 ⁽²⁾	259.0	305.0 ⁽²⁾	245.0	276.0 ⁽²⁾	227.0	244.0 ⁽²⁾
190	B	290.0	323.0 ⁽⁴⁾	282.0	310.0 ⁽³⁾	267.0	303.0 ⁽³⁾	250.0	292.0 ⁽²⁾	236.0	279.0 ⁽²⁾	222.0	257.0 ⁽²⁾	203.0	229.0 ⁽²⁾
	BW	302.0	422.0 ⁽²⁾	286.0	399.0 ⁽²⁾	272.0	370.0 ⁽²⁾	260.0	340.0 ⁽²⁾	245.0	304.0 ⁽²⁾	232.0	276.0 ⁽²⁾	216.0	243.0 ⁽²⁾
200	B	273.0	306.0 ⁽⁵⁾	264.0	295.0 ⁽⁴⁾	253.0	283.0 ⁽³⁾	237.0	274.0 ⁽³⁾	223.0	261.0 ⁽²⁾	212.0	256.0 ⁽²⁾	193.0	228.0 ⁽²⁾
	BW	285.0	404.0 ⁽²⁾	272.0	388.0 ⁽²⁾	257.0	362.0 ⁽²⁾	246.0	336.0 ⁽²⁾	231.0	301.0 ⁽²⁾	221.0	275.0 ⁽²⁾	205.0	243.0 ⁽²⁾
220	B	241.0	276.0 ⁽⁷⁾	230.0	262.0 ⁽⁶⁾	224.0	253.0 ⁽⁵⁾	214.0	246.0 ⁽⁴⁾	197.0	231.0 ⁽³⁾	189.0	224.0 ⁽³⁾	174.0	210.0 ⁽²⁾
	BW	243.0	360.0 ⁽³⁾	243.0	353.0 ⁽²⁾	230.0	344.0 ⁽²⁾	220.0	326.0 ⁽²⁾	206.0	293.0 ⁽²⁾	197.0	268.0 ⁽²⁾	184.0	238.0 ⁽²⁾
240	B		245.0 ⁽⁹⁾	202.0	237.0 ⁽⁷⁾	194.0	229.0 ⁽⁶⁾	184.0	219.0 ⁽⁵⁾	176.0	205.0 ⁽⁴⁾	167.0	198.0 ⁽⁴⁾	156.0	188.0 ⁽³⁾
	BW		323.0 ⁽⁵⁾	203.0	317.0 ⁽⁴⁾	206.0	308.0 ⁽³⁾	198.0	301.0 ⁽²⁾	185.0	283.0 ⁽²⁾	176.0	283.0 ⁽²⁾	165.0	232.0 ⁽²⁾
260	B		213.0 ⁽¹¹⁾		209.0 ⁽⁹⁾	172.0	202.0 ⁽⁷⁾	165.0	194.0 ⁽⁶⁾	154.0	182.0 ⁽⁵⁾	148.0	177.0 ⁽⁵⁾	138.0	167.0 ⁽⁴⁾
	BW		290.0 ⁽⁷⁾		283.0 ⁽⁵⁾	170.0	275.0 ⁽⁴⁾	178.0	271.0 ⁽³⁾	167.0	265.0 ⁽³⁾	156.0	249.0 ⁽³⁾	147.0	225.0 ⁽²⁾
280	B		179.0 ⁽¹¹⁾		183.0 ⁽¹¹⁾		181.0 ⁽¹⁰⁾	142.0	174.0 ⁽⁸⁾	138.0	167.0 ⁽⁷⁾	131.0	160.0 ⁽⁶⁾	121.0	149.0 ⁽⁵⁾
	BW		257.0 ⁽⁸⁾		252.0 ⁽⁶⁾		243.0 ⁽⁵⁾	143.0	243.0 ⁽⁴⁾	148.0	235.0 ⁽³⁾	141.0	232.0 ⁽³⁾	129.0	217.0 ⁽³⁾
300	B		149.0 ⁽¹¹⁾		156.0 ⁽¹¹⁾		158.0 ⁽¹¹⁾		155.0 ⁽¹⁰⁾	115.0	145.0 ⁽⁸⁾	112.0	144.0 ⁽⁷⁾	105.0	132.0 ⁽⁴⁾
	BW		225.0 ⁽⁸⁾		220.0 ⁽⁶⁾		214.0 ⁽⁵⁾		213.0 ⁽⁴⁾	118.0	206.0 ⁽⁴⁾	124.0	206.0 ⁽³⁾	116.0	194.0 ⁽³⁾
320	B		119.0 ⁽¹¹⁾		127.0 ⁽¹¹⁾		132.0 ⁽¹¹⁾		133.0 ⁽¹¹⁾		130.0 ⁽¹⁰⁾	92.3	122.0 ⁽⁸⁾	86.3	117.0 ⁽⁷⁾
	BW		194.0 ⁽⁹⁾		194.0 ⁽⁸⁾		188.0 ⁽⁷⁾		185.0 ⁽⁵⁾		180.0 ⁽⁴⁾	97.6	176.0 ⁽³⁾	96.3	169.0 ⁽³⁾
340	B		87.6 ⁽⁹⁾		98.9 ⁽¹¹⁾		106.0 ⁽¹¹⁾		111.0 ⁽¹¹⁾		110.0 ⁽¹¹⁾		109.0 ⁽¹⁰⁾	71.1	98.5 ⁽⁸⁾
	BW		166.0 ⁽⁹⁾		170.0 ⁽⁹⁾		166.0 ⁽⁸⁾		162.0 ⁽⁶⁾		156.0 ⁽⁵⁾		153.0 ⁽⁴⁾	76.3	147.0 ⁽⁴⁾
360	B		64.7 ⁽⁹⁾		69.7 ⁽⁹⁾		79.9 ⁽¹¹⁾		87.1 ⁽¹¹⁾		89.6 ⁽¹¹⁾		91.9 ⁽¹¹⁾		86.6 ⁽¹⁰⁾
	BW		140.0 ⁽⁹⁾		145.0 ⁽⁹⁾		145.0 ⁽⁹⁾		144.0 ⁽⁹⁾		137.0 ⁽⁷⁾		133.0 ⁽⁶⁾		127.0 ⁽⁴⁾
380	B				48.4 ⁽⁹⁾		52.4 ⁽⁹⁾		62.7 ⁽¹¹⁾		66.9 ⁽¹¹⁾		72.6 ⁽¹¹⁾		71.4 ⁽¹¹⁾
	BW				111.0 ⁽⁷⁾		118.0 ⁽⁹⁾		123.0 ⁽⁹⁾		121.0 ⁽⁸⁾		117.0 ⁽⁶⁾		110.0 ⁽⁵⁾
400	B						32.4 ⁽⁹⁾				44.3 ⁽¹¹⁾		51.3 ⁽¹¹⁾		17.5 ⁽⁵⁾
	BW						98.5 ⁽⁹⁾		108.0 ⁽⁹⁾		108.0 ⁽⁹⁾		103.0 ⁽⁸⁾		95.6 ⁽⁶⁾
420	B												29.9 ⁽¹¹⁾		
	BW						73.8 ⁽⁷⁾		72.0 ⁽⁷⁾		84.8 ⁽⁹⁾		88.4 ⁽⁹⁾		84.2 ⁽⁸⁾
440	B														
	BW						55.5 ⁽⁷⁾		60.6 ⁽⁷⁾		66.4 ⁽⁹⁾		73.7 ⁽⁹⁾		74.3 ⁽⁹⁾
460	B														
	BW								44.7 ⁽⁷⁾		42.9 ⁽⁷⁾		53.4 ⁽⁹⁾		57.3 ⁽⁹⁾
480	B														
	BW										29.6 ⁽⁷⁾		21.6 ⁽³⁾		38.4 ⁽⁹⁾

1) 12° 2) 17° 3) 22° 4) 27° 5) 32° 6) 37° 7) 42° 8) 47° 9) 52° 10) 57° 11) 62°

PDW3B/PDW3BW

P 315

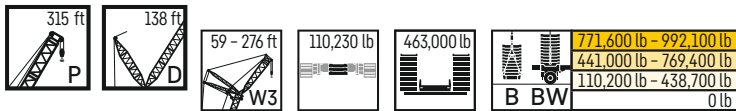

		P 315 ft																									
ft	B BW	W3 59 ft		W3 79 ft		W3 98 ft		W3 118 ft		W3 138 ft		W3 158 ft		W3 177 ft		W3 197 ft		W3 217 ft		W3 236 ft		W3 256 ft		W3 276 ft			
		87°/85	WVmax	87°/85	WVmax	87°/85	WVmax	87°/85	WVmax	87°/85	WVmax	87°/85	WVmax	87°/85	WVmax	87°/85	WVmax	87°/85	WVmax	87°/85	WVmax	87°/85	WVmax	87°/85	WVmax	87°/85	WVmax
50	B	898.0*	898.0*																								
	BW	914.0*	914.0*																								
60	B	838.0*	888.0 ⁽²⁾	781.0*	789.0 ⁽²⁾	731.0*	741.0 ⁽¹⁾																				
	BW	847.0*	906.0 ⁽²⁾	793.0*	800.0 ⁽²⁾	745.0*	755.0 ⁽¹⁾																				
70	B	861.0	864.0 ⁽²⁾	804.0	804.0	692.0*	743.0 ⁽¹⁾	645.0*	669.0 ⁽¹⁾	601.0*	605.0 ⁽¹⁾																
	BW	869.0	899.0 ⁽²⁾	816.0	816.0	707.0*	763.0 ⁽¹⁾	658.0*	686.0 ⁽¹⁾	612.0*	612.0*																
80	B	805.0	820.0 ⁽²⁾	753.0	763.0 ⁽²⁾	709.0	720.0 ⁽¹⁾	660.0	663.0 ⁽¹⁾	566.0*	602.0 ⁽¹⁾	527.0*	529.0 ⁽¹⁾	490.0*	490.0*	389.0*	389.0*										
	BW	793.0	887.0 ⁽²⁾	750.0	795.0 ⁽²⁾	737.0	760.0 ⁽¹⁾	685.0	689.0 ⁽¹⁾	583.0*	587.0 ⁽²⁾	541.0*	541.0*	501.0*	501.0*												
90	B	720.0	777.0 ⁽²⁾	699.0	728.0 ⁽²⁾	662.0	694.0 ⁽¹⁾	621.0	642.0 ⁽¹⁾	581.0	586.0 ⁽¹⁾	540.0	540.0	466.0*	466.0*	432.0*	432.0*	397.0*	397.0*	319.0*	319.0*						
	BW	718.0	875.0 ⁽²⁾	686.0	791.0 ⁽²⁾	690.0	755.0 ⁽¹⁾	647.0	684.0 ⁽¹⁾	605.0	605.0	560.0	560.0	478.0*	478.0*	443.0*	443.0*	406.0*	406.0*								
100	B		726.0 ⁽²⁾	643.0	692.0 ⁽²⁾	619.0	668.0 ⁽¹⁾	583.0	622.0 ⁽¹⁾	549.0	562.0 ⁽¹⁾	512.0	512.0	481.0	481.0	409.0*	409.0*	383.0*	383.0*	350.0*	350.0*	321.0*	321.0*				
	BW		853.0 ⁽²⁾	628.0	788.0 ⁽²⁾	638.0	750.0 ⁽¹⁾	604.0	680.0 ⁽¹⁾	570.0	588.0 ⁽²⁾	533.0	533.0	497.0	497.0	423.0*	425.0 ⁽²⁾	390.0*	390.0*	358.0*	358.0*	328.0*	328.0*				
110	B		660.0 ⁽⁵⁾	577.0	647.0 ⁽²⁾	581.0	633.0 ⁽¹⁾	547.0	601.0 ⁽¹⁾	517.0	539.0 ⁽²⁾	485.0	496.0 ⁽²⁾	457.0	457.0	424.0	424.0	394.0	394.0	335.0*	335.0*	308.0*	308.0*				
	BW		804.0 ⁽²⁾	571.0	769.0 ⁽²⁾	592.0	737.0 ⁽¹⁾	560.0	676.0 ⁽¹⁾	533.0	586.0 ⁽²⁾	503.0	526.0 ⁽²⁾	473.0	474.0 ⁽²⁾	440.0	440.0	406.0	406.0	344.0*	344.0*	316.0*	316.0*	289.0*	289.0*		
120	B		605.0 ⁽⁹⁾		594.0 ⁽⁴⁾	537.0	581.0 ⁽²⁾	514.0	565.0 ⁽¹⁾	486.0	522.0 ⁽²⁾	458.0	483.0 ⁽²⁾	434.0	447.0 ⁽²⁾	404.0	404.0	378.0	378.0	346.0	346.0	319.0	319.0				
	BW		755.0 ⁽²⁾		727.0 ⁽²⁾	552.0	701.0 ⁽¹⁾	520.0	654.0 ⁽¹⁾	497.0	584.0 ⁽²⁾	470.0	525.0 ⁽²⁾	446.0	473.0 ⁽²⁾	420.0	427.0 ⁽²⁾	391.0	391.0	362.0	362.0	329.0	329.0	279.0*	279.0*		
130	B		552.0 ⁽¹⁰⁾		547.0 ⁽⁷⁾	500.0	539.0 ⁽⁴⁾	479.0	521.0 ⁽²⁾	458.0	504.0 ⁽²⁾	432.0	469.0 ⁽²⁾	412.0	438.0 ⁽²⁾	384.0	398.0 ⁽²⁾	361.0	365.0 ⁽²⁾	333.0	333.0	306.0	306.0				
	BW		704.0 ⁽³⁾		686.0 ⁽²⁾	513.0	666.0 ⁽¹⁾	488.0	628.0 ⁽¹⁾	463.0	582.0 ⁽²⁾	440.0	524.0 ⁽²⁾	420.0	473.0 ⁽²⁾	397.0	427.0 ⁽²⁾	373.0	384.0 ⁽²⁾	347.0	347.0	319.0	319.0	291.0	291.0		
140	B		499.0 ⁽¹¹⁾		508.0 ⁽¹⁰⁾		497.0 ⁽⁶⁾	447.0	487.0 ⁽⁴⁾	433.0	470.0 ⁽²⁾	408.0	456.0 ⁽²⁾	387.0	429.0 ⁽²⁾	365.0	392.0 ⁽²⁾	345.0	361.0 ⁽²⁾	319.0	325.0 ⁽²⁾	294.0	294.0				
	BW		656.0 ⁽⁶⁾		644.0 ⁽²⁾		630.0 ⁽¹⁾	457.0	599.0 ⁽²⁾	433.0	565.0 ⁽²⁾	413.0	523.0 ⁽²⁾	394.0	473.0 ⁽²⁾	374.0	427.0 ⁽²⁾	353.0	384.0 ⁽²⁾	332.0	345.0 ⁽²⁾	307.0	308.0 ⁽²⁾	282.0	282.0		
150	B		449.0 ⁽¹¹⁾		465.0 ⁽¹⁰⁾		462.0 ⁽⁸⁾	419.0	454.0 ⁽⁵⁾	403.0	442.0 ⁽¹⁾	384.0	424.0 ⁽²⁾	367.0	420.0 ⁽²⁾	344.0	386.0 ⁽²⁾	327.0	357.0 ⁽²⁾	304.0	323.0 ⁽²⁾	282.0	290.0 ⁽²⁾				
	BW		611.0 ⁽¹⁰⁾		602.0 ⁽²⁾		591.0 ⁽¹⁾	426.0	570.0 ⁽²⁾	406.0	542.0 ⁽²⁾	387.0	508.0 ⁽²⁾	370.0	473.0 ⁽²⁾	352.0	427.0 ⁽²⁾	334.0	384.0 ⁽²⁾	315.0	345.0 ⁽²⁾	294.0	308.0 ⁽²⁾	273.0	276.0 ⁽²⁾		
160	B				422.0 ⁽¹¹⁾		430.0 ⁽¹¹⁾		422.0 ⁽⁶⁾	377.0	418.0 ⁽¹⁾	360.0	397.0 ⁽³⁾	346.0	389.0 ⁽²⁾	324.0	379.0 ⁽²⁾	309.0	354.0 ⁽²⁾	289.0	321.0 ⁽²⁾	269.0	290.0 ⁽²⁾				
	BW				562.0 ⁽⁵⁾		553.0 ⁽⁸⁾		541.0 ⁽²⁾	383.0	520.0 ⁽²⁾	366.0	492.0 ⁽²⁾	348.0	461.0 ⁽²⁾	331.0	426.0 ⁽²⁾	315.0	384.0 ⁽²⁾	298.0	345.0 ⁽²⁾	280.0	309.0 ⁽²⁾	262.0	276.0 ⁽²⁾		
170	B				381.0 ⁽¹¹⁾		396.0 ⁽¹¹⁾		394.0 ⁽⁸⁾	355.0	394.0 ⁽¹⁾	340.0	373.0 ⁽⁴⁾	328.0	366.0 ⁽³⁾	307.0	349.0 ⁽²⁾	292.0	347.0 ⁽²⁾	274.0	319.0 ⁽²⁾	257.0	289.0 ⁽²⁾				
	BW				526.0 ⁽¹⁰⁾		519.0 ⁽⁸⁾		508.0 ⁽²⁾	359.0	498.0 ⁽²⁾	343.0	475.0 ⁽²⁾	329.0	449.0 ⁽²⁾	312.0	417.0 ⁽²⁾	297.0	382.0 ⁽²⁾	282.0	345.0 ⁽²⁾	266.0	309.0 ⁽²⁾	250.0	277.0 ⁽²⁾		
180	B				353.0 ⁽¹⁰⁾		360.0 ⁽¹¹⁾		371.0 ⁽¹¹⁾		370.0 ⁽¹⁾	321.0	350.0 ⁽⁵⁾	310.0	345.0 ⁽⁴⁾	291.0	330.0 ⁽³⁾	277.0	320.0 ⁽²⁾	259.0	311.0 ⁽²⁾	244.0	288.0 ⁽²⁾				
	BW				492.0 ⁽¹⁰⁾		486.0 ⁽⁹⁾		476.0 ⁽⁵⁾		469.0 ⁽³⁾	323.0	459.0 ⁽²⁾	311.0	436.0 ⁽²⁾	294.0	408.0 ⁽²⁾	280.0	377.0 ⁽²⁾	266.0	344.0 ⁽²⁾	251.0	310.0 ⁽²⁾	237.0	277.0 ⁽²⁾		
190	B				324.0 ⁽¹⁰⁾		324.0 ⁽¹⁰⁾		340.0 ⁽¹¹⁾		346.0 ⁽¹⁾	302.0	331.0 ⁽⁷⁾	292.0	326.0 ⁽⁵⁾	275.0	313.0 ⁽⁴⁾	263.0	304.0 ⁽³⁾	245.0	287.0 ⁽²⁾	232.0	280.0 ⁽²⁾				
	BW				458.0 ⁽¹⁰⁾		455.0 ⁽¹⁰⁾		448.0 ⁽⁸⁾		441.0 ⁽⁴⁾	302.0	433.0 ⁽²⁾	293.0	424.0 ⁽²⁾	280.0	400.0 ⁽²⁾	264.0	372.0 ⁽²⁾	251.0	341.0 ⁽²⁾	237.0	309.0 ⁽²⁾	225.0	277.0 ⁽²⁾		
200	B				296.0 ⁽¹⁰⁾		299.0 ⁽¹⁰⁾		310.0 ⁽¹¹⁾		322.0 ⁽¹⁾		313.0 ⁽⁸⁾	276.0	309.0 ⁽⁴⁾	262.0	295.0 ⁽³⁾	249.0	289.0 ⁽⁴⁾	233.0	274.0 ⁽³⁾	220.0	258.0 ⁽³⁾				
	BW				424.0 ⁽¹⁰⁾		426.0 ⁽¹⁰⁾		423.0 ⁽⁸⁾		416.0 ⁽⁵⁾		408.0 ⁽³⁾	277.0	401.0 ⁽²⁾	264.0	392.0 ⁽²⁾	249.0	367.0 ⁽²⁾	237.0	338.0 ⁽²⁾	224.0	306.0 ⁽²⁾	213.0	276.0 ⁽²⁾		
220	B				239.0 ⁽¹⁰⁾		250.0 ⁽¹⁰⁾		258.0 ⁽¹⁰⁾		274.0 ⁽¹⁾		277.0 ⁽¹¹⁾		270.0 ⁽⁸⁾	230.0	261.0 ⁽⁴⁾	222.0	255.0 ⁽⁵⁾	209.0	242.0 ⁽⁴⁾	196.0	232.0 ⁽⁴⁾				
	BW				356.0 ⁽¹⁰⁾		366.0 ⁽¹⁰⁾		373.0 ⁽¹⁰⁾		372.0 ⁽⁹⁾		365.0 ⁽⁶⁾		359.0 ⁽⁴⁾	236.0	352.0 ⁽³⁾	225.0	344.0 ⁽²⁾	214.0	332.0 ⁽²⁾	201.0	300.0 ⁽²⁾	190.0	270.0 ⁽²⁾		
240	B						200.0 ⁽¹⁰⁾		214.0 ⁽¹⁰⁾		227.0 ⁽¹⁾		232.0 ⁽¹¹⁾		240.0 ⁽¹⁾		230.0 ⁽⁹⁾	199.0	330.0 ⁽²⁾	187.0	219.0 ⁽⁴⁾	177.0	211.0 ⁽⁵⁾				
	BW						307.0 ⁽¹⁰⁾		322.0 ⁽¹⁰⁾		330.0 ⁽¹⁰⁾		328.0 ⁽⁹⁾		322.0 ⁽⁴⁾		317.0 ⁽⁵⁾	201.0	309.0 ⁽⁴⁾	191.0	240.0 ⁽³⁾	181.0	214.0 ⁽⁵⁾	171.0	265.0 ⁽²⁾		
260	B						164.0 ⁽⁸⁾		171.0 ⁽¹⁰⁾		185.0 ⁽¹⁰⁾		192.0 ⁽¹⁰⁾		205.0 ⁽¹¹⁾		206.0 ⁽¹¹⁾		200.0 ⁽⁹⁾	168.0	195.0 ⁽⁷⁾	158.0	188.0 ⁽⁶⁾				
	BW						260.0 ⁽⁸⁾		270.0 ⁽¹⁰⁾		284.0 ⁽¹⁰⁾		289.0 ⁽¹⁰⁾		290.0 ⁽⁹⁾		285.0 ⁽⁷⁾		278.0 ⁽⁵⁾	172.0	273.0 ⁽⁴⁾	163.0	265.0 ⁽³⁾	153.0	256.0 ⁽³⁾		
280	B						131.0 ⁽⁸⁾		138.0 ⁽⁸⁾		147.0 ⁽¹⁰⁾		157.0 ⁽¹⁰⁾		172.0 ⁽¹¹⁾		175.0 ⁽¹¹⁾		178.0 ⁽¹¹⁾		170.0 ⁽⁹⁾	141.0	164.0 ⁽⁷⁾				
	BW						216.0 ⁽⁸⁾		228.0 ⁽⁸⁾		239.0 ⁽¹⁰⁾		250.0 ⁽¹⁰⁾		257.0 ⁽¹⁰⁾		256.0 ⁽⁹⁾		252.0 ⁽⁹⁾		244.0 ⁽⁵⁾	144.0	238.0 ⁽⁴⁾	137.0	234.0 ⁽⁴⁾		
300	B						108.0 ⁽⁸⁾		115.0 ⁽⁸⁾		122.0 ⁽¹⁰⁾		122.0 ⁽¹⁰⁾		139.0 ⁽¹¹⁾		144.0 ⁽¹¹⁾		152.0 ⁽¹¹⁾		151.0 ⁽¹¹⁾		143.0 ⁽⁹⁾				
	BW						188.0 ⁽⁸⁾		199.0 ⁽⁸⁾		210.0 ⁽¹⁰⁾		222.0 ⁽¹⁰⁾		225.0 ⁽⁹⁾		225.0 ⁽⁹⁾		224.0 ⁽⁸⁾		219.0 ⁽⁷⁾		214.0 ⁽⁵⁾	121.0	209.0 ⁽⁵⁾		
320	B								88.1 ⁽⁸⁾		92.9 ⁽⁸⁾		92.9 ⁽⁸⁾		107.0 ⁽¹¹⁾		115.0 ⁽¹¹⁾		124.0 ⁽¹¹⁾		127.0 ⁽¹¹⁾		127.0 ⁽¹¹⁾				
	BW								162.0 ⁽⁸⁾		173.0 ⁽⁸⁾		173.0 ⁽⁸⁾		188.0 ⁽¹¹⁾		193.0 ⁽⁹⁾		195.0 ⁽⁸⁾		194.0 ⁽⁸⁾		186.0 ⁽⁵⁾		184.0 ⁽⁵⁾		
340	B								61.9 ⁽⁶⁾																		

PDW3B/PDW3BW

P 354

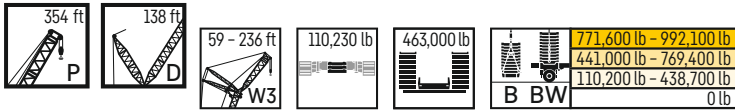

		P 354 ft																			
ft	B BW	W3 59 ft		W3 79 ft		W3 98 ft		W3 118 ft		W3 138 ft		W3 158 ft		W3 177 ft		W3 197 ft		W3 217 ft		W3 236 ft	
		87°/85	WVmax	87°/85	WVmax	87°/85	WVmax	87°/85	WVmax	87°/85	WVmax	87°/85	WVmax	87°/85	WVmax	87°/85	WVmax	87°/85	WVmax	87°/85	WVmax
50	B	749.0*	749.0*																		
	BW	759.0*	759.0*																		
60	B	709.0*	733.0 ⁽²⁾																		
	BW	717.0*	734.0 ⁽²⁾	662.0*	662.0*	613.0*	614.0 ⁽¹⁾														
70	B	728.0	728.0																		
	BW	709.0	718.0 ⁽²⁾	614.0*	639.0 ⁽²⁾	587.0*	610.0 ⁽¹⁾	542.0*	543.0 ⁽¹⁾	454.0*	454.0*										
80	B	683.0	702.0 ⁽²⁾																		
	BW	653.0	723.0 ⁽²⁾	608.0	630.0 ⁽²⁾	593.0	607.0 ⁽¹⁾	515.0*	525.0 ⁽²⁾	476.0*	476.0*	434.0*	434.0*	362.0*	362.0*						
90	B	638.0	680.0 ⁽²⁾																		
	BW	596.0	727.0 ⁽²⁾	557.0	636.0 ⁽²⁾	558.0	604.0 ⁽¹⁾	516.0	516.0	478.0	478.0	412.0*	415.0 ⁽²⁾	382.0*	382.0*	347.0*	347.0*	285.0*	285.0*		
100	B	535.0	657.0 ⁽²⁾																		
	BW	532.0	732.0 ⁽²⁾	511.0	642.0 ⁽²⁾	522.0	602.0 ⁽¹⁾	486.0	516.0 ⁽²⁾	453.0	458.0 ⁽²⁾	417.0	417.0	386.0	386.0	332.0*	332.0*	304.0*	304.0*	279.0*	279.0*
110	B		615.0 ⁽²⁾																		
	BW		716.0 ⁽²⁾	481.0	649.0 ⁽²⁾	489.0	599.0 ⁽¹⁾	457.0	517.0 ⁽²⁾	429.0	460.0 ⁽²⁾	396.0	407.0 ⁽²⁾	369.0	369.0	338.0	338.0	290.0*	292.0 ⁽²⁾	267.0*	267.0*
120	B		561.0 ⁽²⁾																		
	BW		688.0 ⁽²⁾		636.0 ⁽²⁾	459.0	590.0 ⁽¹⁾	429.0	518.0 ⁽²⁾	404.0	462.0 ⁽²⁾	376.0	409.0 ⁽²⁾	351.0	366.0 ⁽²⁾	323.0	323.0	297.0	297.0	273.0	273.0
130	B		512.0 ⁽⁴⁾																		
	BW		660.0 ⁽²⁾		616.0 ⁽²⁾	439.0	578.0 ⁽¹⁾	405.0	519.0 ⁽²⁾	382.0	465.0 ⁽²⁾	355.0	411.0 ⁽²⁾	334.0	367.0 ⁽²⁾	308.0	324.0 ⁽²⁾	284.0	287.0 ⁽²⁾	262.0	262.0
140	B		470.0 ⁽⁷⁾																		
	BW		626.0 ⁽³⁾		597.0 ⁽²⁾		567.0 ⁽¹⁾	389.0	510.0 ⁽²⁾	360.0	467.0 ⁽²⁾	336.0	413.0 ⁽²⁾	318.0	369.0 ⁽²⁾	293.0	325.0 ⁽²⁾	271.0	288.0 ⁽²⁾	251.0	257.0 ⁽²⁾
150	B		431.0 ⁽¹¹⁾																		
	BW		586.0 ⁽⁶⁾		576.0 ⁽²⁾		556.0 ⁽¹⁾	366.0	501.0 ⁽²⁾	341.0	460.0 ⁽²⁾	318.0	413.0 ⁽²⁾	301.0	370.0 ⁽²⁾	279.0	327.0 ⁽²⁾	258.0	289.0 ⁽²⁾	239.0	258.0 ⁽²⁾
160	B		398.0 ⁽¹¹⁾																		
	BW		551.0 ⁽¹⁰⁾		541.0 ⁽²⁾		526.0 ⁽²⁾		492.0 ⁽²⁾	329.0	453.0 ⁽²⁾	303.0	407.0 ⁽²⁾	286.0	370.0 ⁽²⁾	265.0	328.0 ⁽²⁾	246.0	290.0 ⁽²⁾	229.0	259.0 ⁽²⁾
170	B																				
	BW				507.0 ⁽⁶⁾		494.0 ⁽³⁾		483.0 ⁽²⁾	310.0	447.0 ⁽²⁾	291.0	402.0 ⁽²⁾	272.0	365.0 ⁽²⁾	251.0	326.0 ⁽²⁾	234.0	291.0 ⁽²⁾	219.0	260.0 ⁽²⁾
180	B																				
	BW				476.0 ⁽⁷⁾		464.0 ⁽⁵⁾		455.0 ⁽³⁾		440.0 ⁽²⁾	275.0	397.0 ⁽²⁾	264.0	361.0 ⁽²⁾	239.0	323.0 ⁽²⁾	224.0	290.0 ⁽²⁾	208.0	260.0 ⁽²⁾
190	B																				
	BW				445.0 ⁽⁷⁾		437.0 ⁽⁷⁾		429.0 ⁽⁴⁾		421.0 ⁽³⁾	260.0	392.0 ⁽²⁾	249.0	356.0 ⁽²⁾	230.0	319.0 ⁽²⁾	213.0	286.0 ⁽²⁾	198.0	258.0 ⁽²⁾
200	B																				
	BW				414.0 ⁽⁷⁾		409.0 ⁽⁷⁾		405.0 ⁽⁴⁾		400.0 ⁽⁴⁾		376.0 ⁽³⁾	236.0	352.0 ⁽²⁾	221.0	315.0 ⁽²⁾	202.0	283.0 ⁽²⁾	189.0	255.0 ⁽²⁾
220	B																				
	BW				354.0 ⁽¹⁰⁾		356.0 ⁽¹⁰⁾		358.0 ⁽⁷⁾		356.0 ⁽⁵⁾		343.0 ⁽³⁾		327.0 ⁽³⁾	198.0	302.0 ⁽³⁾	187.0	277.0 ⁽²⁾	174.0	248.0 ⁽²⁾
240	B																				
	BW						305.0 ⁽¹⁰⁾		310.0 ⁽⁷⁾		312.0 ⁽⁷⁾		306.0 ⁽⁴⁾		301.0 ⁽⁵⁾		283.0 ⁽⁴⁾	169.0	265.0 ⁽³⁾	159.0	241.0 ⁽³⁾
260	B																				
	BW								266.0 ⁽¹⁰⁾		271.0 ⁽¹⁰⁾		266.0 ⁽⁷⁾		269.0 ⁽⁷⁾		262.0 ⁽⁴⁾		244.0 ⁽⁴⁾	142.0	228.0 ⁽⁴⁾
280	B																				
	BW								217.0 ⁽⁸⁾		234.0 ⁽¹⁰⁾		234.0 ⁽¹⁰⁾		237.0 ⁽⁷⁾		232.0 ⁽⁶⁾		227.0 ⁽⁶⁾		215.0 ⁽⁵⁾
300	B																				
	BW								167.0 ⁽⁸⁾		188.0 ⁽⁸⁾		202.0 ⁽¹⁰⁾		207.0 ⁽¹¹⁾		205.0 ⁽¹¹⁾		200.0 ⁽⁷⁾		195.0 ⁽⁶⁾
320	B																				
	BW								117.0 ⁽⁸⁾		144.0 ⁽⁸⁾		167.0 ⁽⁹⁾		178.0 ⁽¹¹⁾		179.0 ⁽¹¹⁾		177.0 ⁽¹¹⁾		171.0 ⁽⁹⁾
340	B																				
	BW										98.9 ⁽⁸⁾		124.0 ⁽⁹⁾		144.0 ⁽⁹⁾		153.0 ⁽¹¹⁾		154.0 ⁽¹¹⁾		155.0 ⁽¹¹⁾
360	B																				
	BW											81.9 ⁽⁹⁾		105.0 ⁽⁹⁾		122.0 ⁽⁹⁾		131.0 ⁽¹¹⁾		133.0 ⁽¹¹⁾	
380	B																				
	BW													66.6 ⁽⁹⁾		86.3 ⁽⁹⁾		104.0 ⁽⁹⁾		111.0 ⁽¹¹⁾	
400	B																				
	BW															51.0 ⁽⁹⁾		70.6 ⁽⁹⁾		60.0 ⁽⁵⁾	
420	B																				
	BW																	37.7 ⁽⁹⁾			31.7 ⁽⁵⁾

1) 12° 2) 17° 3) 22° 4) 27° 5) 32° 6) 37° 7) 42° 8) 47° 9) 52° 10) 57° 11) 62°

PDW3B/PDW3BW

P 374 - 394

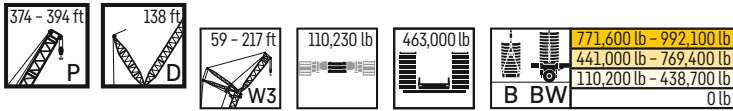

ft	B BW	P 374 ft														P 394 ft								
		W3 59 ft		W3 79 ft		W3 98 ft		W3 118 ft		W3 138 ft		W3 158 ft		W3 177 ft		W3 197 ft		W3 217 ft		W3 59 ft		W3 79 ft		
		87°/85	WVmax	87°/85	WVmax	87°/85	WVmax	87°/85	WVmax	87°/85	WVmax	87°/85	WVmax	87°/85	WVmax	87°/85	WVmax	87°/85	WVmax	87°/85	WVmax	87°/85	WVmax	
60	B																							
	BW	643.0*	655.0 ⁽²⁾	591.0*	591.0*	557.0*	557.0*														575.0*	582.0 ⁽²⁾	527.0*	527.0*
70	B																							
	BW	630.0	630.0	549.0*	567.0 ⁽²⁾	532.0*	545.0 ⁽¹⁾	487.0*	490.0 ⁽¹⁾	445.0*	445.0*										561.0	561.0	491.0*	501.0 ⁽²⁾
80	B																							
	BW	580.0	615.0 ⁽²⁾	540.0	548.0 ⁽²⁾	525.0	534.0 ⁽¹⁾	462.0*	477.0 ⁽¹⁾	424.0*	432.0 ⁽¹⁾	387.0*	390.0 ⁽¹⁾	355.0*	355.0*						515.0	541.0 ⁽¹⁾	477.0	483.0 ⁽¹⁾
90	B																							
	BW	527.0	601.0 ⁽²⁾	495.0	535.0 ⁽²⁾	494.0	524.0 ⁽¹⁾	457.0	464.0 ⁽¹⁾	422.0	422.0	368.0*	378.0 ⁽¹⁾	339.0*	343.0 ⁽¹⁾	308.0*	308.0*	284.0*	284.0*	469.0	521.0 ⁽¹⁾	438.0	467.0 ⁽¹⁾	
100	B																							
	BW	487.0	587.0 ⁽²⁾	451.0	522.0 ⁽²⁾	461.0	513.0 ⁽¹⁾	430.0	450.0 ⁽¹⁾	400.0	408.0 ⁽¹⁾	369.0	369.0	323.0*	331.0 ⁽¹⁾	294.0*	294.0*	272.0*	272.0*	438.0	500.0 ⁽¹⁾	400.0	452.0 ⁽¹⁾	
110	B																							
	BW		578.0 ⁽²⁾	429.0	510.0 ⁽²⁾	432.0	502.0 ⁽¹⁾	403.0	437.0 ⁽¹⁾	378.0	395.0 ⁽¹⁾	350.0	354.0 ⁽²⁾	326.0	326.0	299.0	299.0	260.0*	260.0*		480.0 ⁽¹⁾	381.0	437.0 ⁽¹⁾	
120	B																							
	BW		584.0 ⁽²⁾	383.0	506.0 ⁽²⁾	405.0	491.0 ⁽¹⁾	380.0	425.0 ⁽²⁾	355.0	384.0 ⁽²⁾	332.0	347.0 ⁽²⁾	310.0	315.0 ⁽²⁾	286.0	286.0	266.0	266.0		460.0 ⁽¹⁾	341.0	422.0 ⁽¹⁾	
130	B																							
	BW		590.0 ⁽²⁾		518.0 ⁽²⁾	390.0	480.0 ⁽¹⁾	357.0	416.0 ⁽²⁾	334.0	376.0 ⁽²⁾	313.0	340.0 ⁽²⁾	294.0	309.0 ⁽²⁾	272.0	279.0 ⁽²⁾	253.0	253.0		448.0 ⁽²⁾		406.0 ⁽¹⁾	
140	B																							
	BW		596.0 ⁽²⁾		530.0 ⁽²⁾	360.0	476.0 ⁽²⁾	345.0	416.0 ⁽²⁾	316.0	368.0 ⁽²⁾	295.0	334.0 ⁽²⁾	278.0	303.0 ⁽²⁾	257.0	273.0 ⁽²⁾	241.0	249.0 ⁽²⁾		442.0 ⁽²⁾		391.0 ⁽¹⁾	
150	B																							
	BW		575.0 ⁽²⁾		541.0 ⁽²⁾		483.0 ⁽²⁾	324.0	421.0 ⁽²⁾	298.0	368.0 ⁽²⁾	280.0	327.0 ⁽²⁾	263.0	297.0 ⁽²⁾	244.0	268.0 ⁽²⁾	229.0	244.0 ⁽²⁾		434.0 ⁽²⁾		382.0 ⁽²⁾	
160	B																							
	BW		539.0 ⁽³⁾		527.0 ⁽³⁾		490.0 ⁽²⁾	299.0	427.0 ⁽²⁾	290.0	372.0 ⁽²⁾	265.0	328.0 ⁽²⁾	249.0	291.0 ⁽²⁾	232.0	263.0 ⁽²⁾	219.0	239.0 ⁽²⁾		417.0 ⁽²⁾		376.0 ⁽²⁾	
170	B																							
	BW		505.0 ⁽⁹⁾		495.0 ⁽⁵⁾		477.0 ⁽²⁾		432.0 ⁽²⁾	273.0	377.0 ⁽²⁾	258.0	331.0 ⁽²⁾	236.0	293.0 ⁽²⁾	220.0	257.0 ⁽²⁾	208.0	235.0 ⁽²⁾		399.0 ⁽²⁾		363.0 ⁽²⁾	
180	B																							
	BW		472.0 ⁽⁹⁾		467.0 ⁽⁸⁾		453.0 ⁽⁴⁾		426.0 ⁽³⁾	254.0	381.0 ⁽²⁾	243.0	334.0 ⁽²⁾	231.0	295.0 ⁽²⁾	208.0	259.0 ⁽²⁾	196.0	231.0 ⁽²⁾		382.0 ⁽²⁾		350.0 ⁽²⁾	
190	B																							
	BW		439.0 ⁽⁹⁾		439.0 ⁽¹⁰⁾		427.0 ⁽⁶⁾		416.0 ⁽⁴⁾		375.0 ⁽³⁾	229.0	337.0 ⁽²⁾	220.0	297.0 ⁽²⁾	198.0	261.0 ⁽²⁾	186.0	232.0 ⁽²⁾		365.0 ⁽²⁾		337.0 ⁽²⁾	
200	B																							
	BW		406.0 ⁽⁹⁾		411.0 ⁽¹⁰⁾		403.0 ⁽⁹⁾		395.0 ⁽⁵⁾		368.0 ⁽³⁾	215.0	332.0 ⁽²⁾	209.0	300.0 ⁽²⁾	193.0	263.0 ⁽²⁾	177.0	233.0 ⁽²⁾		348.0 ⁽²⁾		325.0 ⁽²⁾	
220	B																							
	BW		340.0 ⁽⁹⁾		355.0 ⁽¹⁰⁾		355.0 ⁽¹⁰⁾		352.0 ⁽⁸⁾		349.0 ⁽⁴⁾		320.0 ⁽⁴⁾		294.0 ⁽³⁾	174.0	262.0 ⁽²⁾	167.0	236.0 ⁽²⁾		315.0 ⁽⁴⁾		299.0 ⁽²⁾	
240	B																							
	BW						299.0 ⁽¹⁰⁾		305.0 ⁽¹⁰⁾		308.0 ⁽⁹⁾		308.0 ⁽⁹⁾		299.0 ⁽⁶⁾		279.0 ⁽⁵⁾		249.0 ⁽⁴⁾	148.0	230.0 ⁽³⁾		273.0 ⁽⁴⁾	
260	B																							
	BW						254.0 ⁽⁸⁾		254.0 ⁽¹⁰⁾		265.0 ⁽¹⁰⁾		271.0 ⁽¹⁰⁾		272.0 ⁽¹⁰⁾		266.0 ⁽⁷⁾		237.0 ⁽⁵⁾		221.0 ⁽⁴⁾		245.0 ⁽⁸⁾	
280	B																							
	BW						218.0 ⁽⁸⁾		215.0 ⁽⁸⁾		223.0 ⁽¹⁰⁾		234.0 ⁽¹⁰⁾		238.0 ⁽¹⁰⁾		239.0 ⁽¹⁰⁾		225.0 ⁽⁷⁾		209.0 ⁽⁶⁾		211.0 ⁽⁸⁾	
300	B																							
	BW						182.0 ⁽⁸⁾		182.0 ⁽⁸⁾		187.0 ⁽⁸⁾		196.0 ⁽¹⁰⁾		205.0 ⁽¹⁰⁾		210.0 ⁽¹¹⁾		209.0 ⁽¹⁰⁾		198.0 ⁽⁸⁾		178.0 ⁽⁸⁾	
320	B																							
	BW						149.0 ⁽⁸⁾		157.0 ⁽⁸⁾		164.0 ⁽⁸⁾		171.0 ⁽¹⁰⁾		181.0 ⁽¹¹⁾		182.0 ⁽¹⁰⁾		186.0 ⁽¹¹⁾					
340	B																							
	BW								128.0 ⁽⁸⁾		137.0 ⁽⁸⁾		142.0 ⁽⁸⁾		152.0 ⁽¹¹⁾		156.0 ⁽¹¹⁾		162.0 ⁽¹¹⁾					
360	B																							
	BW								103.0 ⁽⁴⁾		109.0 ⁽⁸⁾		116.0 ⁽⁸⁾		125.0 ⁽⁹⁾		130.0 ⁽¹¹⁾		138.0 ⁽¹¹⁾					
380	B																							
	BW								81.2 ⁽⁴⁾				91.1 ⁽⁸⁾		102.0 ⁽⁹⁾		105.0 ⁽⁹⁾		114.0 ⁽¹¹⁾					
400	B																							
	BW																							
420	B																							
	BW																							
440	B																							
	BW																							
460	B																							
	BW																							

1) 12° 2) 17° 3) 22° 4) 27° 5) 32° 6) 37° 7) 42° 8) 47° 9) 52° 10) 57° 11) 62°

Lifting heights

Hauteurs de levage

PDW3B/PDW3BW

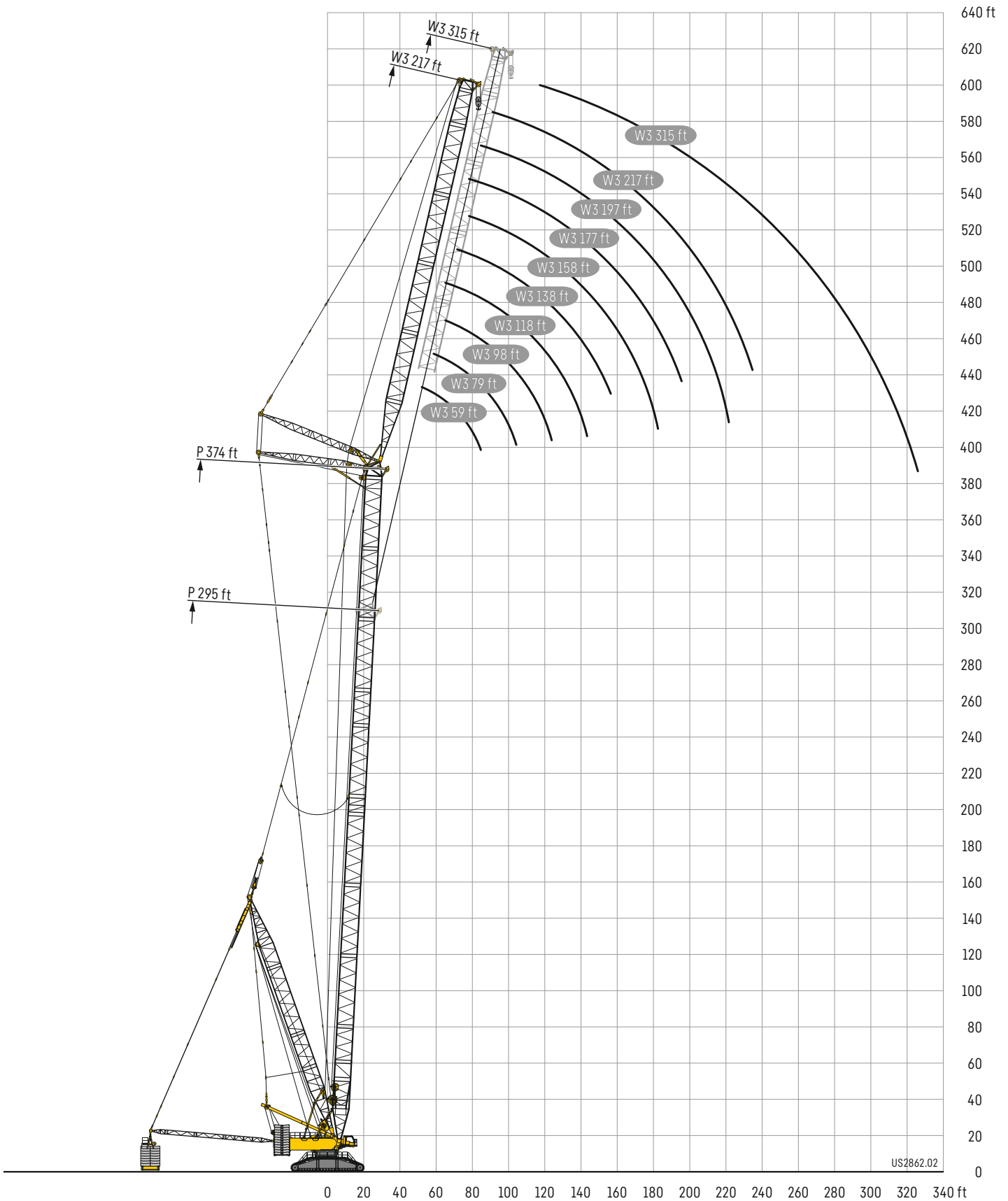

SL8F2

SL8 276 - 295

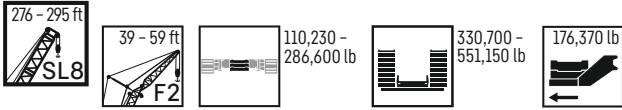

ft	SL8 276 ft		
	F2 39 ft	F2 49 ft	F2 59 ft
	10°	10°	10°
50	557		
60	558	474	475
70	512	512	454
80	441	441	426
90	384	384	388
100	338	339	342
110	300	301	304
120	268	268	272
130	241	241	245
140	217	218	221
150	196	197	200
160	177	179	182
170	159	161	166
180	144	145	150
190	130	131	135
200	117	119	123
220	95.8	97.2	101
240	78.5	79.8	83.3
260	64.2	65.3	68.1
280			56
300			

ft	SL8 295 ft		
	F2 39 ft	F2 49 ft	F2 59 ft
	10°	10°	10°
60	558	458	322
70	497	496	456
80	428	428	428
90	373	373	377
100	328	328	332
110	291	291	295
120	259	260	264
130	232	233	237
140	209	209	213
150	189	189	193
160	170	171	175
170	155	155	159
180	140	141	145
190	126	127	132
200	113	115	119
220	91.8	93.3	97.2
240	74.4	75.5	79
260	60	61.2	64.2
280	47.1	48	52.1
300			40.9
320			

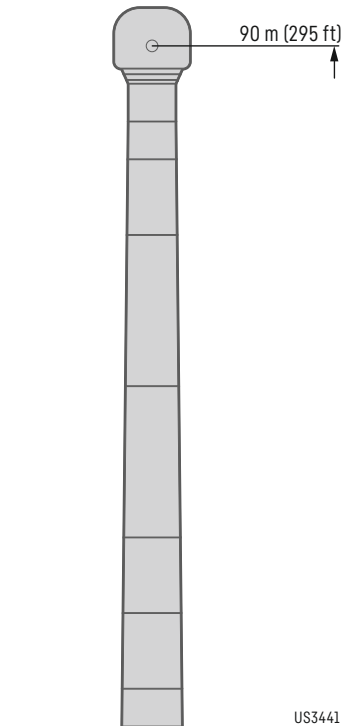
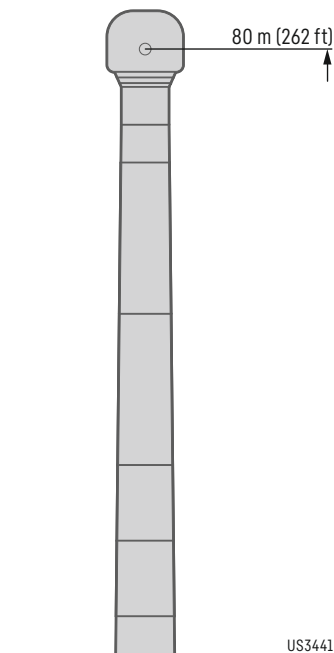

SL8F2

SL8 335

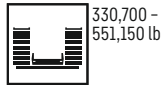
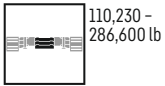

ft	SL8 335 ft		
	F2 39 ft	F2 49 ft	F2 59 ft
	10°	10°	10°
60	546	360	
70	466	466	455
80	401	402	405
90	348	349	354
100	306	307	311
110	270	271	276
120	239	241	245
130	213	215	219
140	191	192	196
150	171	172	177
160	154	155	159
170	138	139	144
180	124	125	130
190	112	113	117
200	100	101	106
220	80.7	81.7	85.8
240	63.7	65	68.7
260	49.2	50.2	54.7
280	37.2	38.1	41.2
300	26.8	27.9	31.3
320		18.8	22
340			

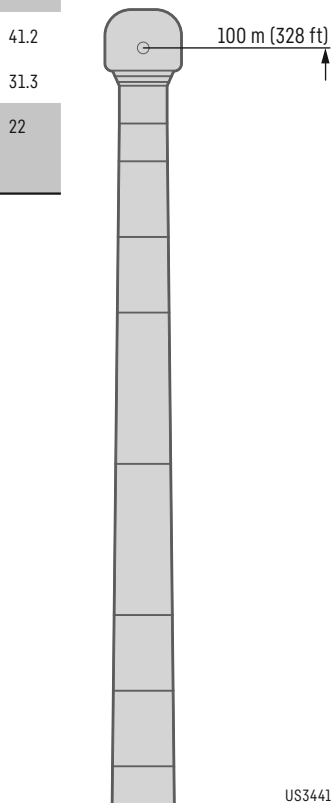

US3441

SL8F2

SL8 354

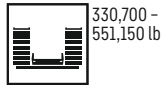
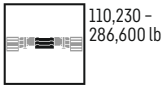

ft	SL8 354 ft		
	F2 39 ft	F2 49 ft	F2 59 ft
	10°	10°	10°
60	512		
70	451	451	424
80	387	391	393
90	336	341	342
100	294	298	300
110	259	263	265
120	229	233	235
130	203	208	210
140	181	185	187
150	161	166	168
160	145	148	150
170	129	133	135
180	115	119	121
190	103	107	109
200	91.7	95.6	97.5
220	72.3	76	77.8
240	56	59.6	61.3
260	42.3	45.4	47.2
280	30.6	33.6	35.3
300	20.6	23.3	24.9
320	11.6	14.2	15.9

ft	SL8 354 ft	
	F2 59 ft	
	10°	
60		
70	424	
80	393	
90	342	
100	300	
110	265	
120	235	
130	210	
140	187	
150	168	
160	150	
170	135	
180	121	
190	109	
200	97.5	
220	77.8	
240	61.3	
260	47.2	
280	35.3	
300	24.9	
320	15.9	

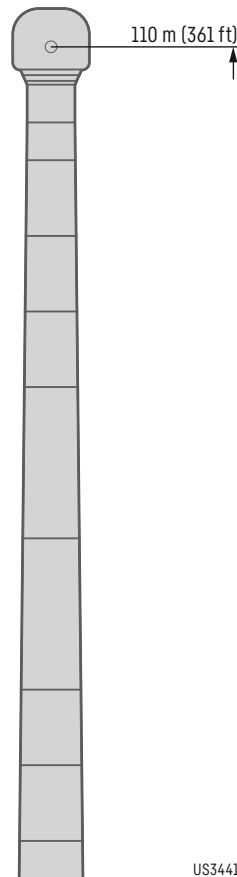

US3441

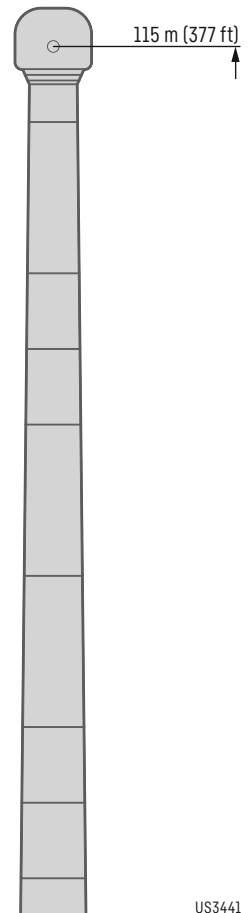

US3441

SL8F2

SL8 335

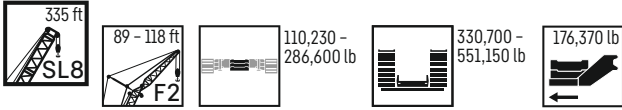

ft	SL8 335 ft	
	F2 89 ft	F2 98 ft
	10°	10°
80	306	
90	290	274
100	276	260
110	264	248
120	248	237
130	223	226
140	201	205
150	181	185
160	164	168
170	148	152
180	134	138
190	122	126
200	110	115
220	90.4	94.6
240	73.6	77.7
260	59.4	62.8
280	45.2	49.3
300	35.7	38.8
320	26.5	30.1
340	18.1	21.6
360		14

ft	SL8 335 ft	
	F2 118 ft	
	10°	
80		
90	242	
100	230	
110	218	
120	208	
130	198	
140	190	
150	181	
160	167	
170	151	
180	138	
190	125	
200	114	
220	94.5	
240	78	
260	63.6	
280	50.1	
300	39.5	
320	31.4	
340	22.8	
360	15.3	

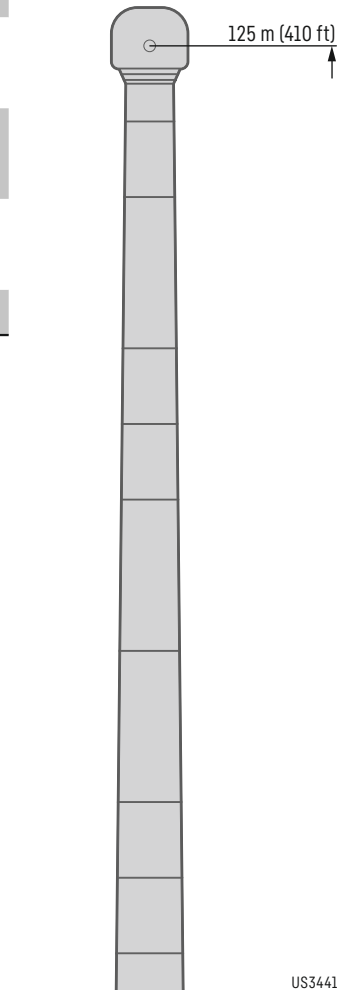
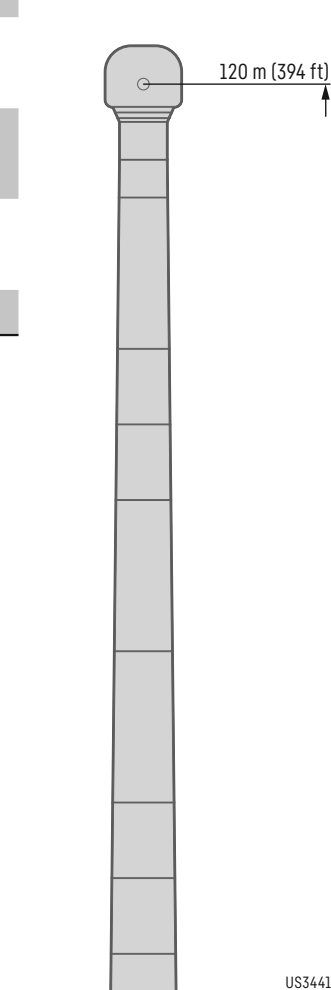

Lifting heights

Hauteurs de levage

SL8F2

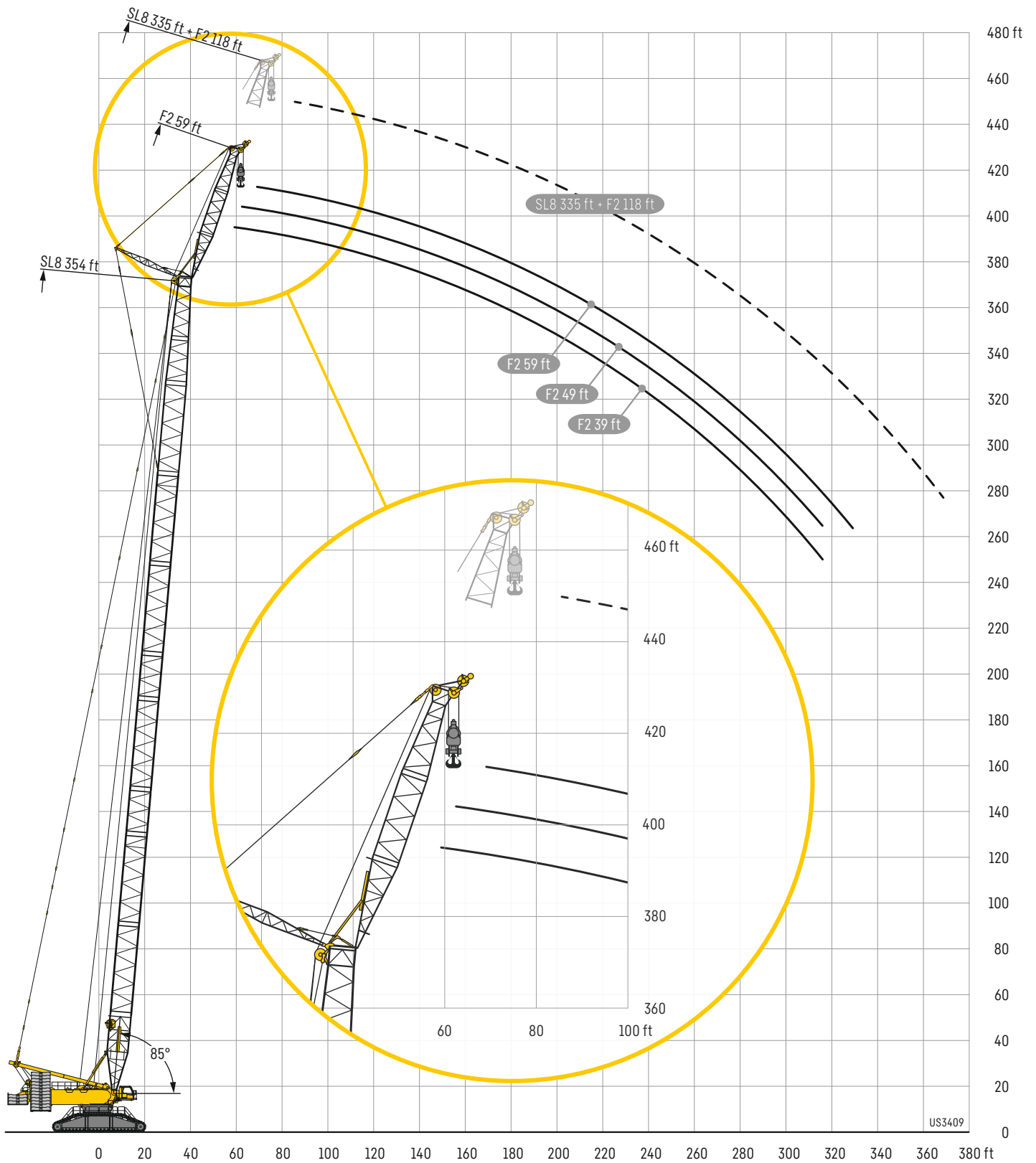

SL10DF2B/BV

SL10 492 - 532

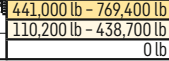
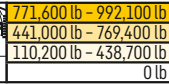

ft	B BV	SL10 492 ft		
		F2 39 ft	F2 49 ft	F2 59 ft
		10°	10°	10°
70	-	258		
	B	401		
	BV			
80	-	214	217	222
	B	397	372	349
	BV	403	378	340
90	-	177	181	185
	B	392	368	346
	BV	403	376	352
100	-	146	150	154
	B	386	363	342
	BV	400	374	349
110	-	120	124	128
	B	381	359	338
	BV	397	372	346
120	-	97.4	101	105
	B	377	355	333
	BV	394	368	341
130	-	78	81.7	85.3
	B	371	349	327
	BV	391	363	337
140	-	61	64.5	68
	B	364	341	320
	BV	385	357	332
150	-	46	49.3	52.8
	B	355	334	314
	BV	378	351	327
160	-	32.6	35.7	39.3
	B	345	324	307
	BV	371	344	322
170	-		23.6	27.1
	B	336	317	297
	BV	363	338	315
180	-	327	307	290
	B	354	330	309
190	-	317	298	281
	B	345	322	302
200	-	302	289	273
	B	337	314	294
220	-	262	262	255
	B	322	299	280
240	-	228	230	232
	B	307	286	268
260	-	198	200	203
	B	289	273	256
280	-	171	174	177
	B	263	258	245
300	-	149	151	154
	B	235	236	234
320	-	129	131	134
	B	210	212	215
340	-	111	113	116
	B	188	189	192
360	-	95.1	97.2	99.8
	B	168	170	173
380	-	81	82.6	85
	B	150	152	154
400	-	67.9	69.3	71.6
	B	133	136	138
420	-	56	57.3	59.2
	B	112	119	123
440	-		46.6	48.2
	B		103	110
460	-			
	B			
480	-			
	B			
500	-			
	B			
520	-			
	B			
540	-			
	B			
	BV			

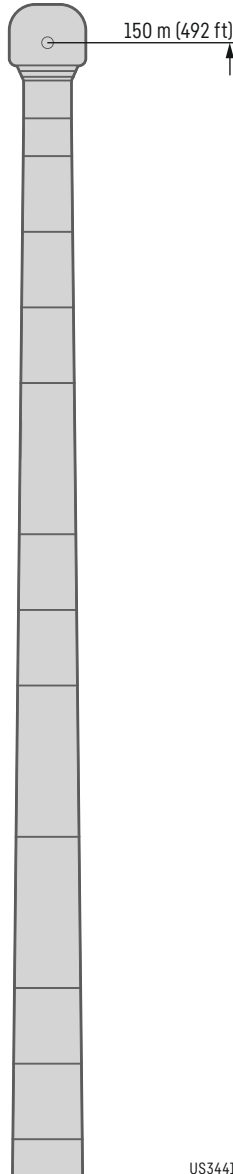

US3441

ft	B BV	SL10 532 ft		
		F2 39 ft	F2 49 ft	F2 59 ft
		10°	10°	10°
80	-			
	B	344	322	
	BV			
90	-			
	B	341	321	303
	BV			
100	-			
	B	339	318	302
	BV			
110	-			
	B	336	316	300
	BV			
120	-			
	B	334	314	298
	BV			
130	-			
	B	331	312	296
	BV			
140	-			
	B	329	310	294
	BV			
150	-			
	B	326	308	292
	BV			
160	-			
	B	324	305	288
	BV			
170	-			
	B	321	301	283
	BV			
180	-			
	B	318	297	279
	BV			
190	-			
	B	312	292	275
	BV			
200	-			
	B	306	286	270
	BV			
220	-			
	B	296	275	260
	BV			
240	-			
	B	285	266	251
	BV			
260	-			
	B	270	256	242
	BV			
280	-			
	B	246	242	234
	BV			
300	-			
	B	219	221	224
	BV			
320	-			
	B	195	197	201
	BV			
340	-			
	B	173	175	180
	BV			
360	-			
	B	153	154	160
	BV			
380	-			
	B	135	137	142
	BV			
400	-			
	B	119	121	125
	BV			
420	-			
	B	104	106	111
	BV			
440	-			
	B	91.1	92.7	97.4
	BV			
460	-			
	B	78.2	80.6	85.1
	BV			
480	-			
	B			73.7
	BV			
500	-			
	B			
	BV			
520	-			
	B			
	BV			
540	-			
	B			
	BV			

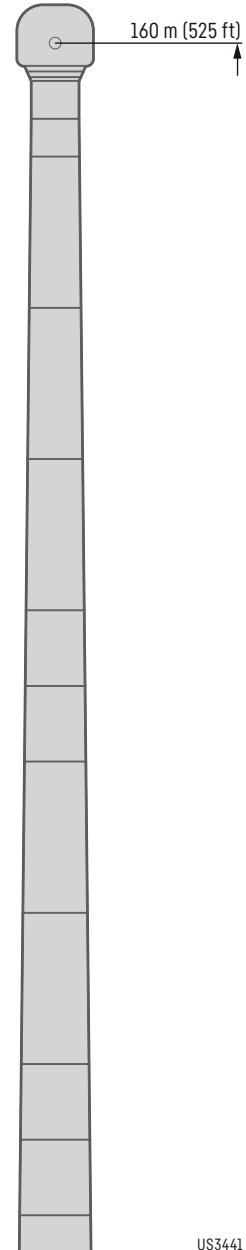

US3441

SL10DF2B/BV

SL10 532 - 551



771,600 lb - 992,100 lb
441,000 lb - 769,400 lb
110,200 lb - 438,700 lb
0 lb

ft	SL10 551 ft		
	F2 39 ft 10°	F2 49 ft 10°	F2 59 ft 10°
80	309		
90	306	290	273
100	304	288	272
110	301	286	270
120	299	283	268
130	296	281	266
140	294	279	264
150	291	277	262
160	289	275	259
170	287	271	255
180	284	268	251
190	280	263	248
200	274	259	244
220	264	249	235
240	254	241	227
260	244	232	220
280	231	224	212
300	212	214	204
320	188	192	191
340	167	171	174
360	146	151	154
380	129	133	136
400	112	117	120
420	97.1	102	105
440	80.5	88.1	91.4
460	56.9	68.5	76.7
480	38.8	46.5	57.1
500			
520			

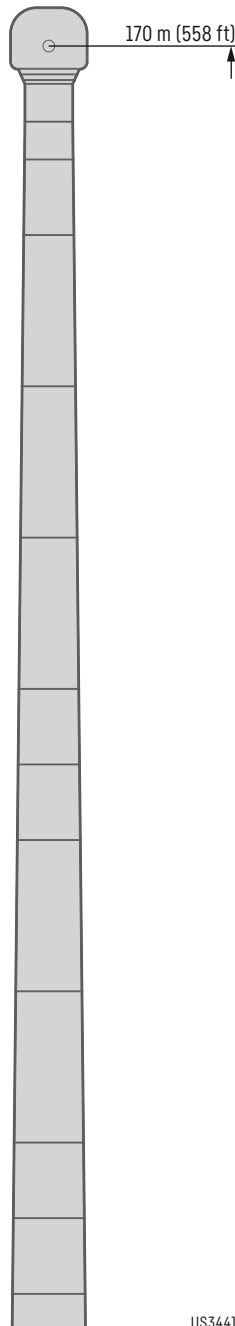

ft	SL10 532 ft		
	F2 89 ft 10°	F2 98 ft 10°	F2 108 ft 10°
90			
100	251	235	219
110	249	232	216
120	246	229	214
130	243	227	211
140	240	224	208
150	238	221	205
160	235	218	202
170	232	214	198
180	228	209	193
190	222	203	187
200	216	197	181

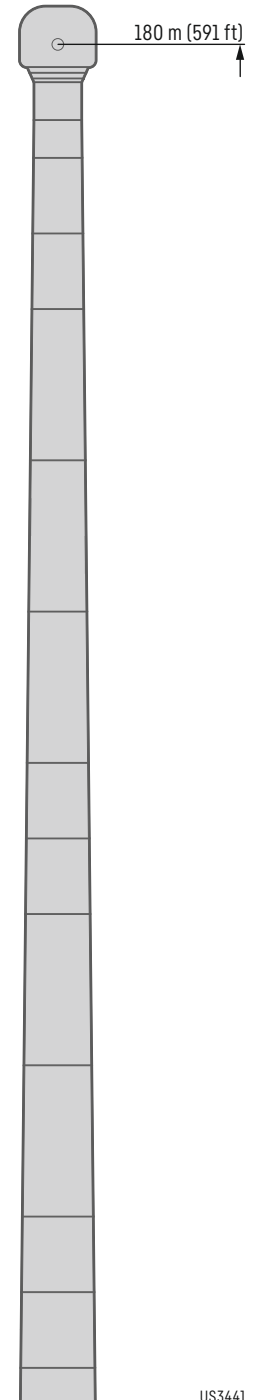

ft	SL10 551 ft		
	F2 59 ft 10°	F2 69 ft 10°	F2 79 ft 10°
90	273	257	
100	272	256	242
110	270	254	241
120	268	253	239
130	266	251	238
140	264	249	235
150	262	246	233
160	259	243	230
170	255	240	227
180	251	236	224
190	248	233	221
200	244	230	217

US3441

US3441

SL10DF2B/BV

SL10 532



		SL10 532 ft		
		F2 108 ft	F2 118 ft	F2 128 ft
		10°	10°	10°
80	B			
	BV			
90	B			
	BV			
100	B			
	BV	219		
110	B			
	BV	216	203	189
120	B			
	BV	214	200	187
130	B			
	BV	211	197	184
140	B			
	BV	208	194	182
150	B			
	BV	205	192	179
160	B			
	BV	202	189	176
170	B			
	BV	198	186	173
180	B			
	BV	193	180	169
190	B			
	BV	187	174	164
200	B			
	BV	181	169	159
220	B			
	BV	171	159	149
240	B			
	BV	161	150	140
260	B			
	BV	153	141	132
280	B			
	BV	146	134	125
300	B			
	BV	139	128	119
320	B			
	BV	133	122	113
340	B			
	BV	128	117	108
360	B			
	BV	123	112	103
380	B			
	BV	118	108	99.3
400	B			
	BV	114	104	95.6
420	B			
	BV	109	101	92
440	B			
	BV	103	97.5	89
460	B			
	BV	93.3	91.8	85.3
480	B			
	BV	81.6	82.3	79.5
500	B			
	BV	71	72.5	72.7
520	B			
	BV	61.2	62.7	63.3
540	B			
	BV			54.2

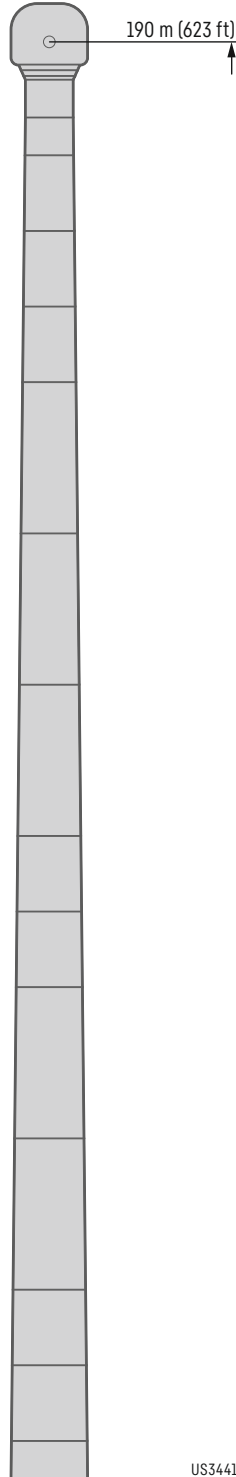

US3441

Lifting heights

Hauteurs de levage

SL10DF2B/BV

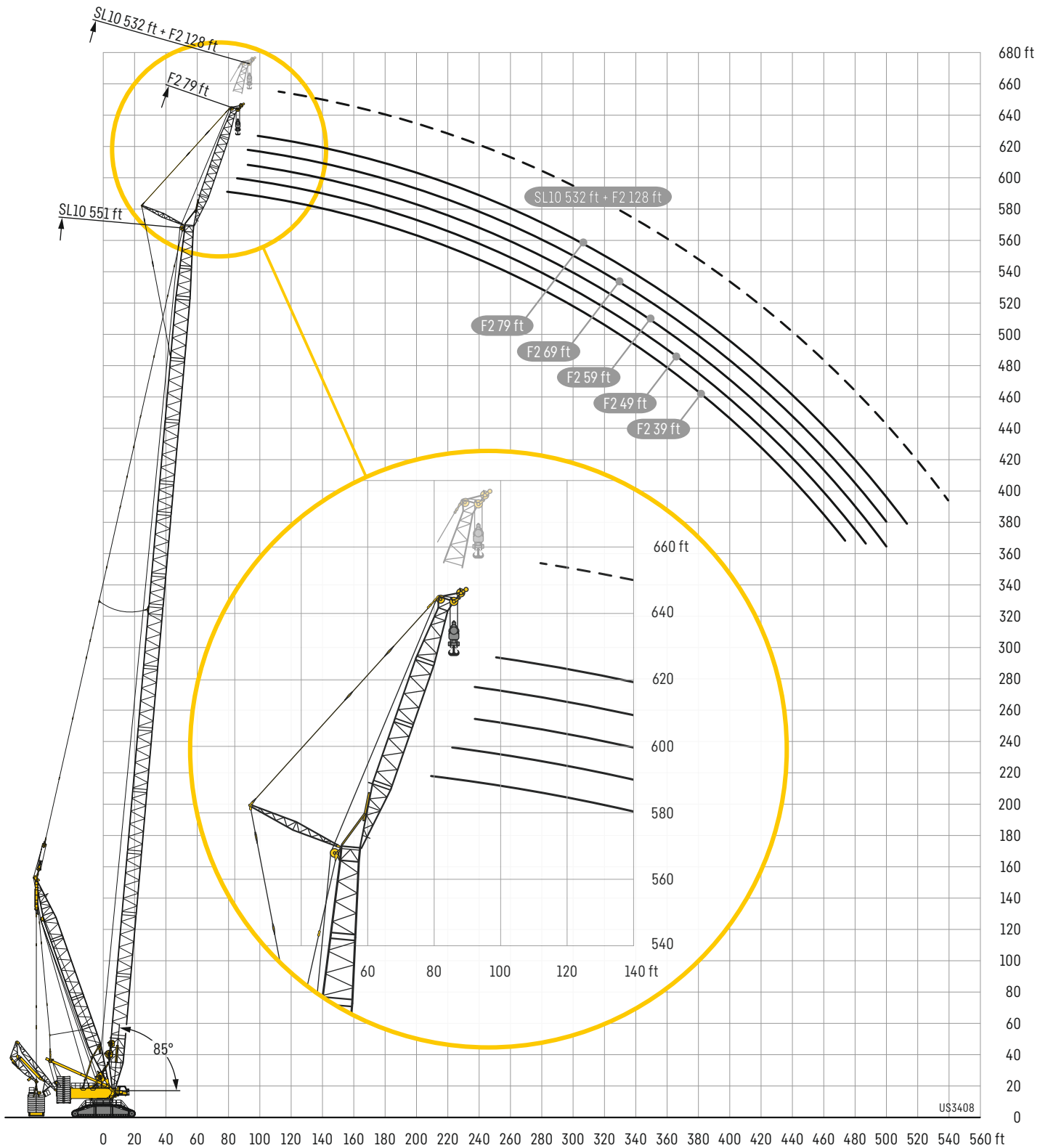

US3408



ft	SL9 256 – 335 ft					ft
	256 ft	276 ft	295 ft	315 ft	335 ft	
36	853					36
38	806	774				38
40	761	733	636			40
50	760	736	711	688	666	50
60	620	601	582	565	547	60
70	517	503	487	474	458	70
80	440	428	414	403	390	80
90	380	369	357	347	336	90
100	330	321	310	301	291	100
110	291	282	271	264	254	110
120	257	249	239	232	223	120
130	228	221	212	205	197	130
140	200	197	188	181	173	140
150	177	174	167	161	153	150
160	157	154	149	143	135	160
170	140	137	132	127	120	170
180	125	122	117	113	106	180
190	111	108	103	100	93.3	190
200	99.7	96.4	91	88	82.1	200
220	80	76.3	70.7	67.4	62.4	220
240		60.2	54.3	50.7	45.5	240
260			40.9	37	31.6	260
280					20	280

Lifting heights

Hauteurs de levage

SL9

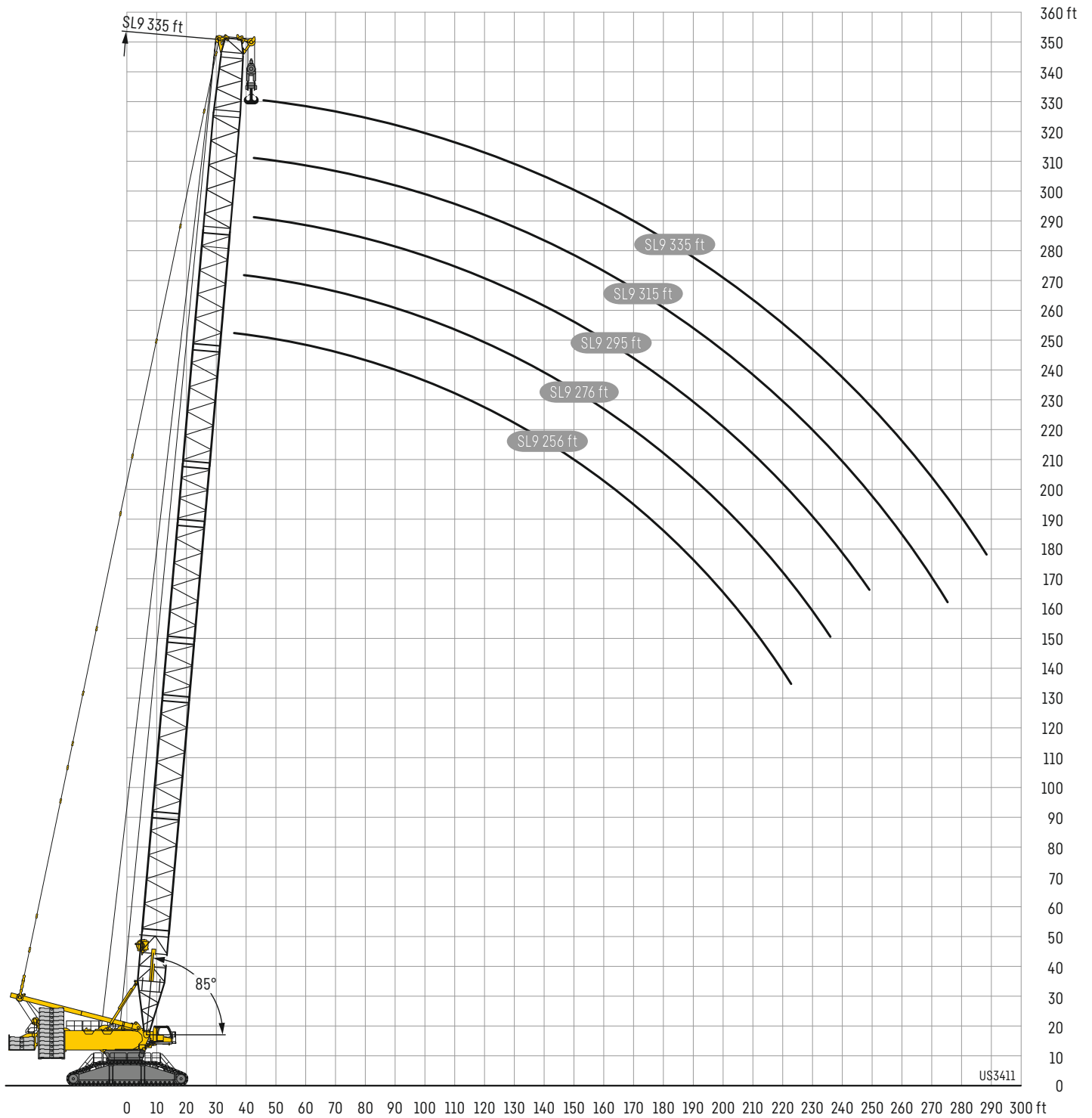

SL11DB/BV

SL11 217 - 532

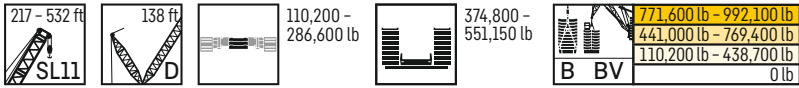

		SL11 217 - 532 ft																	
		217 ft	236 ft	256 ft	276 ft	295 ft	315 ft	335 ft	354 ft	374 ft	394 ft	413 ft	433 ft	453 ft	472 ft	492 ft	512 ft	532 ft	
32	B	1432																	
	BV																		
34	B	1432	1432																
	BV																		
36	B	1432	1432	1432															
	BV																		
38	B	1432	1432	1432	1415														
	BV																		
40	B	1432	1432	1432	1412	1299	1183												
	BV																		
50	B	1432	1432	1432	1375	1287	1173	1068	970	880	820	744							
	BV	1432	1432	1432	1432	1319	1209	1096	992	826									
60	B	1400	1371	1324	1269	1211	1145	1058	962	873	815	741	675	607	547				
	BV	1432	1432	1432	1385	1309	1211	1099	995	899	836	757	687	616	556	515	461	414	
70	B	1216	1200	1182	1151	1115	1070	1020	949	867	810	736	670	601	543				
	BV	1409	1390	1344	1290	1236	1173	1099	997	901	838	759	688	618	557	508	460	413	
80	B	1064	1052	1037	1022	1008	989	959	898	849	798	725	660	594	536				
	BV	1254	1234	1230	1199	1159	1109	1056	981	901	839	759	684	617	558	505	456	408	
90	B	942	932	919	908	897	883	870	842	806	772	711	648	583	528				
	BV	1156	1127	1095	1081	1074	1043	1002	936	884	835	748	679	612	554	499	451	404	
100	B	839	832	820	812	803	793	782	769	751	729	693	636	572	518				
	BV	1069	1045	1015	988	967	956	942	889	847	810	728	672	606	548	494	447	400	
110	B	757	748	739	730	724	715	707	697	684	670	652	622	561	509				
	BV	984	968	947	921	902	877	857	824	804	776	706	665	599	542	489	442	396	
120	B	685	679	669	661	656	647	643	633	623	612	599	587	545	499				
	BV	897	889	875	859	843	823	803	759	740	727	681	658	593	536	484	439	393	
130	B	626	618	610	601	596	589	585	577	569	559	550	543	519	482				
	BV	824	814	804	794	785	770	754	715	693	674	647	636	584	530	478	435	390	
140	B	569	567	558	551	545	538	535	528	520	512	504	499	483	459				
	BV	760	751	739	731	725	716	705	675	656	637	616	603	568	523	474	432	387	
150	B	515	519	514	505	501	494	490	484	478	469	463	460	447	436				
	BV	703	696	685	675	670	662	657	637	622	605	586	576	549	514	472	429	385	
160	B	463	475	476	467	462	455	452	445	439	431	426	422	412	408				
	BV	652	645	637	627	621	614	609	598	588	573	557	551	527	501	468	426	382	
170	B	416	438	440	434	428	421	417	411	405	397	392	390	379	376				
	BV	597	603	592	585	578	570	566	558	551	541	527	522	503	486	458	422	378	
180	B	377	399	402	402	398	391	386	380	375	366	360	360	350	348				
	BV	548	562	554	545	541	533	527	521	514	506	498	493	477	466	447	417	374	
190	B	348	361	367	374	370	364	359	352	347	339	334	332	323	321				
	BV	502	523	519	511	506	499	494	486	480	472	465	463	450	443	426	409	370	
200	B		333	341	346	342	339	335	328	322	315	309	308	298	296				
	BV		477	487	479	475	468	464	456	449	441	435	433	422	418	403	392	362	
220	B			279	286	290	294	292	286	280	271	266	265	255	253				
	BV			421	425	421	414	409	403	397	387	381	381	371	368	354	351	337	
240	B				246	251	255	256	250	244	237	231	229	219	218				
	BV				367	375	369	364	358	351	344	338	335	325	324	311	309	301	
260	B					208	212	212	218	212	206	201	199	189	187				
	BV					322	331	326	319	314	305	300	299	288	286	273	271	264	
280	B							181	183	183	180	175	172	163	162				
	BV							291	287	281	272	267	265	256	254	241	238	232	
300	B								159	160	158	152	150	140	138				
	BV								259	253	244	238	237	227	225	213	211	204	
320	B									138	137	132	130	120	119				
	BV									225	218	214	211	202	199	187	186	180	
340	B										118	115	112	103	100				
	BV										192	192	189	180	174	165	163	156	
360	B											99	97	87.1	85.1				
	BV											170	170	160	147	145	143	134	
380	B													73.6	71.2				
	BV													143	125	128	126	112	
400	B														58.7				
	BV														107	112	110	87.8	
420	B																97.9	93.5	66
	BV																		
440	B																	78.1	48.1
	BV																		
460	B																		
	BV																		36.8

Lifting heights





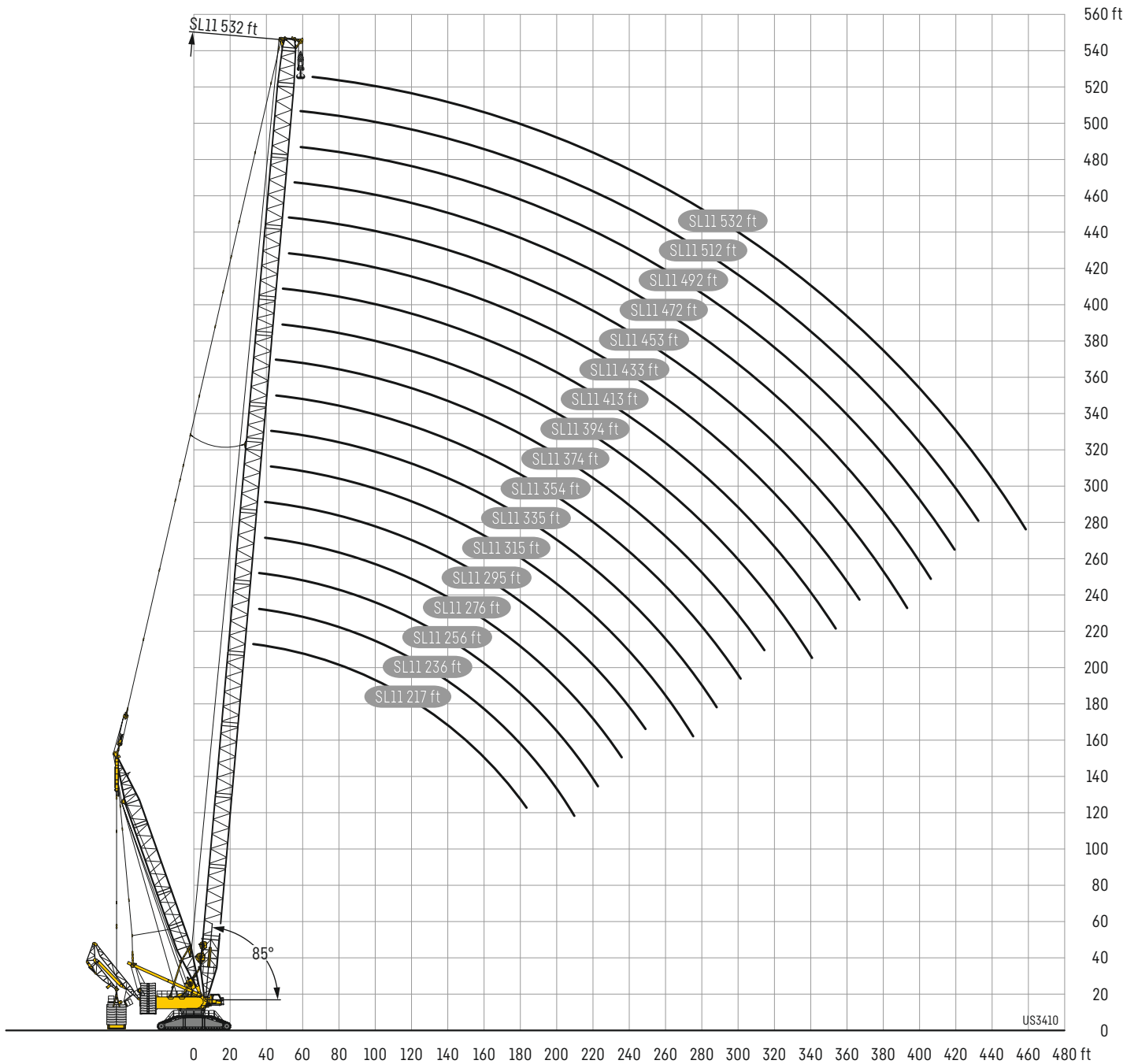























Hauteurs de levage

SL11DB/BV



Description of symbols

Explication des symboles

	Max. capacity Capacité max.		Weight Poids
	Max. boom length Longueur maxi. de la fleche principale		No. of lines Brins
	Max. boom system length Longueur maxi. du systeme de fleche		No. of sheaves Poulies
	Counterweight Contrepoids		Radius Portée
	Central ballast Contrepoids central		Main boom SL/SL2/SL8/SL9/SL10/SL11 Flèche principale SL/SL2/SL8/SL9/SL10/SL11
	Width crawler chassis Largeur du train de chenilles		Main boom S/S2 Flèche principale S/S2
	Hoist gear Treuil de levage		Derrick system D Système derrick D
	Working speeds Vitesses		Main boom P Flèche principale P
	Max. single line pull Effort au brin maxi.		Main boom SL Flèche principale SL
	Rope diameter Diamètre		Fixed lattice jib F2 Flechette a treillis fixe F2
	Rope length Longueur du câble		Counterweight frame B Palette de lest B
	Slewing speeds Vitesses d'orientation		Suspended ballast V-frame V-Frame de contrepoids suspendu
	Driving speed Vitesse de translation		Counterweight trailer BW Remorque à contrepoids BW
	Load Forces de levage		Extension of slewing platform ballast Extension de lest de partie tournante
	Hookblock/Capacity Moufle à crochet/Capacité de charge		

Remarks

1. The lifting capacities do not exceed 75 % of the tipping load according to ASME B 30.5. The crane's structural steelwork is in accordance with EN 13000 and ASME B 30.5.
2. For the calculation of the load charts at least a wind speed of 29 ft/s (9 m/s, 20.1 miles/hour) and regarding the load a sail area of 1 m² per ton load and a wind resistance coefficient of 1.2 on the load have been taken into account. For lifting of loads with large sail areas and/or high wind resistance coefficients the maximum wind speed as stated in the load charts has to be reduced.
3. The lifting capacities stated are valid for lifting operation only (corresponding with crane classification according to ISO 4301-1, crane group A1).
4. Lifting capacities are given in kips.
5. The weight of the hook blocks and hooks is part of the load and therefore it must be deducted from the lifting capacities.
6. The working radii are measured from the slewing centreline.
7. The subsoil must be even and of good bearing capacity.
8. Subject to modification of lifting capacities.
9. The data of this brochure serves only for general information. All information is provided without warranty. Instructions for the correct commissioning of the crane please take from the operation manual and the load chart book.
10. The pictures contain also accessories and special equipment not included in the standard scope of delivery.

Remarques

1. La capacité de charge ne doit pas dépasser 75 % de la charge de basculement conformément à ASME B 30.5. La structure métallique de la grue est conforme à EN 13000 et ASME B 30.5.
2. Une vitesse de vent de 29 ft/s (9 m/s, 20.1 miles/hour) minimum, une surface de prise au vent de 1 m² par tonne ainsi qu'un coefficient de résistance au vent de la charge 1,2 sont pris en compte pour le calcul des tableaux de charge. Lorsque des charges ayant une surface de prise au vent et/ou un coefficient de résistance au vent plus élevé(e)(s) sont levées, la vitesse de vent maximale indiquée dans les tableaux de charge doit être réduite.
3. Forces de levage pour application de grue de montage (correspond à la classification de grues selon ISO 4301-1, groupe de grues A1).
4. Les charges sont indiquées en kips.
5. Le poids du crochet de levage resp. de la moufle à crochet est une partie de la charge et doit donc être déduit de la capacité de charge.
6. Les portées sont prises à partir de l'axe de rotation de la partie tournante.
7. Le sol doit être plat et résistant.
8. Charges données sous réserve de modification.
9. Les données de cette brochure sont données à titre informatif. Ces renseignements sont sans garantie. Les consignes relatives à la bonne mise en service de la grue sont disponibles dans le manuel d'utilisation et le manuel de tableaux de charge.
10. Les figures contiennent également des accessoires et des équipements spéciaux non inclus de série dans la livraison.

Customer Service

Personal. Competent. Reliable.
Personnalisé. Compétent. Fiable.



To ensure your Liebherr remains a Liebherr.

- Commission and training by experienced service technicians
- Worldwide service network with over 80 branches
- 24/7 technical support worldwide
- Fast availability of spare parts
- Attractive packages for maintenance and service

De sorte que votre Liebherr reste une Liebherr.

- Mise en route et formation effectuées par des techniciens qualifiés
- Service-Après-Vente Mondial représenté par plus de 80 correspondants
- Assistance Technique 24/24 et 7/7 jours
- Rapide disponibilité des pièces de rechanges
- Kits d'entretiens pour révisions et maintenances à un prix attractif

Proposition 65



WARNING: This product can expose you to chemicals, including exhaust emissions, including lead and lead compounds, which are known to the State of California to cause cancer, birth defects or other reproductive harm.

For more information see: www.P65warnings.ca.gov/diesel

Änderungen vorbehalten · Subject to modification · Sous réserve de modifications · Con riserva di modifiche · Salvo modificaciones · Возможны изменения

Liebherr-Werk Ehingen GmbH · Postfach 1361 · 89582 Ehingen, Germany
+49 73 91 5 02-0 · www.liebherr.com

Get Your
Contact



Printed in Germany (1)
lwe-tc-235-02-us02-2021